

06

LAVA LOUÇAS
KITCHEN SINKS

94 LAVA LOUÇAS PHILIN
PHILIN KITCHEN SINKS

99 LAVA LOUÇAS INOX
STAINLESS STEEL KITCHEN SINKS

112 MISTURADORAS
FAUCETS

114 MISTURADORAS PHILIN
PHILIN FAUCETS

LAVA LOUÇAS PHILIN

PHILIN KITCHEN SINKS

PHILIN

PHILIN

LAVA LOUÇAS PHILIN

PHILIN KITCHEN SINKS



ELITE R10 400
R10 400 ELITE

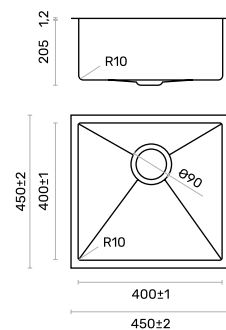

MODELO MODEL	APLICAÇÃO APPLICATION	ACABAMENTO FINISHING	MEDIDA DA PIA SINK MEASURE	PROFUNDIDADE DEPTH	CAIXA BOX	REFERÊNCIA REFERENCE
ELITE R10 400 450X450	Apl. por baixo Undermounted	SATINADO SATIN	R10 400X400	205	01 UN	LLE0004012

ELITE PE R10 1000
R10 1000 ELITE PE

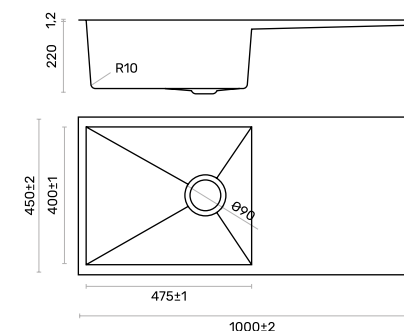

MODELO MODEL	ACABAMENTO FINISHING	MEDIDA DA PIA SINK MEASURE	PROFUNDIDADE DEPTH	CAIXA BOX	REFERÊNCIA REFERENCE
ELITE PE R10 1000 1000X450	INOX STAINLESS STEEL	R10 475X400	220	01 UN	LLEPE10012

i APLICAÇÃO POR BAIXO, APLICAÇÃO À FACE, APLICAÇÃO ENCASTRAR À SUPERFÍCIE.
INSET, UNDERMOUNTED



ELITE R10 500
R10 500 ELITE

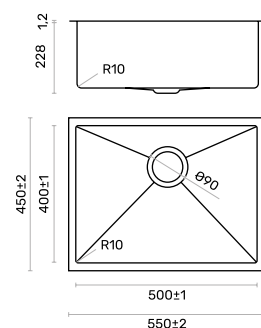

MODELO MODEL	APLICAÇÃO APPLICATION	ACABAMENTO FINISHING	MEDIDA DA PIA SINK MEASURE	PROFUNDIDADE DEPTH	CAIXA BOX	REFERÊNCIA REFERENCE
ELITE R10 500 550X450	Apl. por baixo Undermounted	SATINADO SATIN	R10 500X400	228	01 UN	LLE0005012
		PVD OURO PVD GOLD				LLE0005006
		PVD ROSA DOURADO PVD GOLDEN ROSE				LLE0005040

MYTHOS Ø370
Ø370 MYTHOS

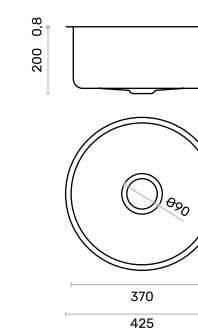

MODELO MODEL	APLICAÇÃO APPLICATION	ACABAMENTO FINISHING	MEDIDA DA PIA SINK MEASURE	PROFUNDIDADE DEPTH	CAIXA BOX	REFERÊNCIA REFERENCE
MYTHOS Ø370 Ø425	Encastrar Inset	SATINADO SATIN	R20 Ø370	200	01 UN	LLM0003712

SMART R20 300
R20 300 SMART

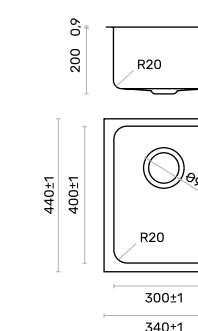

SMART R20 400
R20 400 SMART

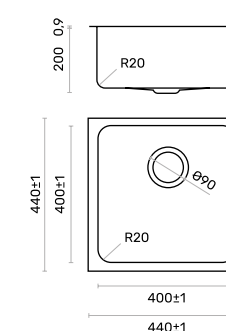

MODELO MODEL	APLICAÇÃO APPLICATION	ACABAMENTO FINISHING	MEDIDA DA PIA SINK MEASURE	PROFUNDIDADE DEPTH	CAIXA BOX	REFERÊNCIA REFERENCE
ELITE R10 700 750X450	Apl. por baixo Undermounted	SATINADO SATIN	R10 700X400	220	01 UN	LLE0007012

MODELO MODEL	APLICAÇÃO APPLICATION	ACABAMENTO FINISHING	MEDIDA DA PIA SINK MEASURE	PROFUNDIDADE DEPTH	CAIXA BOX	REFERÊNCIA REFERENCE
SMART R20 300 450X350	Apl. por baixo Undermounted	SATINADO SATIN	R20 300X400	200	01 UN	LLS0003012
SMART R20 400 450X450	Apl. por baixo Undermounted	SATINADO SATIN	R20 400X400	200	01 UN	LLS0004012

LAVA LOUÇAS PHILIN

PHILIN KITCHEN SINKS

PHILIN

PHILIN

LAVA LOUÇAS PHILIN

PHILIN KITCHEN SINKS

SMART R20 450

R20 450 SMART

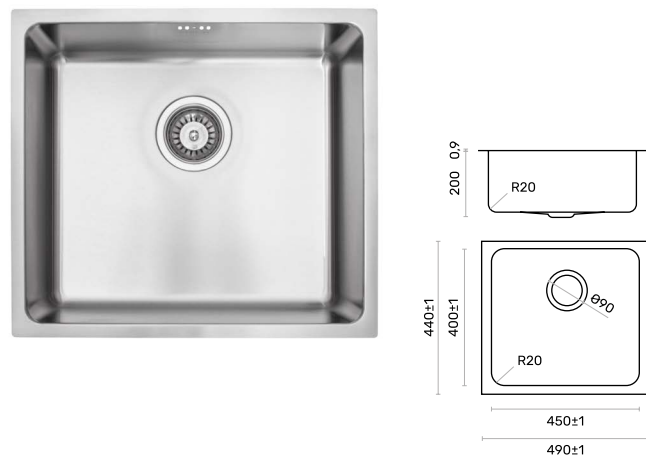

SMART R20 500

R20 500 SMART



MODELO MODEL	APLICAÇÃO APPLICATION	ACABAMENTO FINISHING	MEDIDA DA PIA SINK MEASURE	PROFUNDIDADE DEPTH	CAIXA BOX	REFERÊNCIA REFERENCE
SMART R20 450 500X450	Apl. por baixo Undermounted	SATINADO SATIN	R20 450X400	200	01 UN	LLS0004512
SMART R20 500 550X450	Apl. por baixo Undermounted	SATINADO SATIN	R20 500X400	200	01 UN	LLS0005012

SMART PP R20 765

R20 765 SMART PP

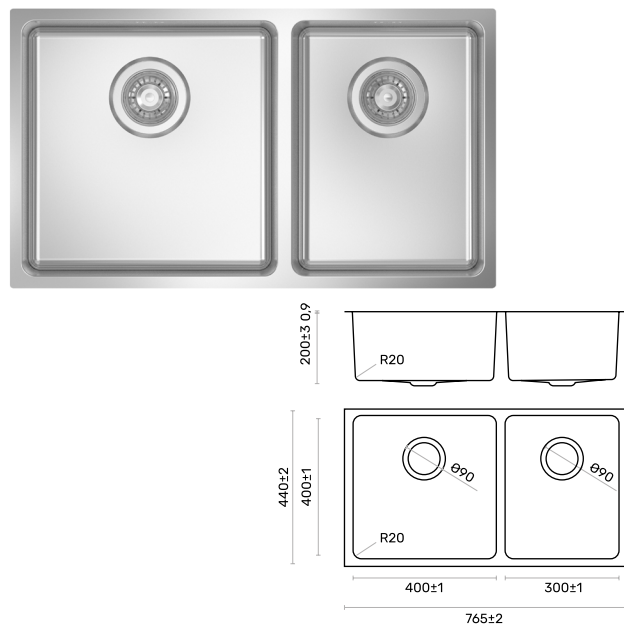

SMART PP R20 865

R20 865 SMART PP

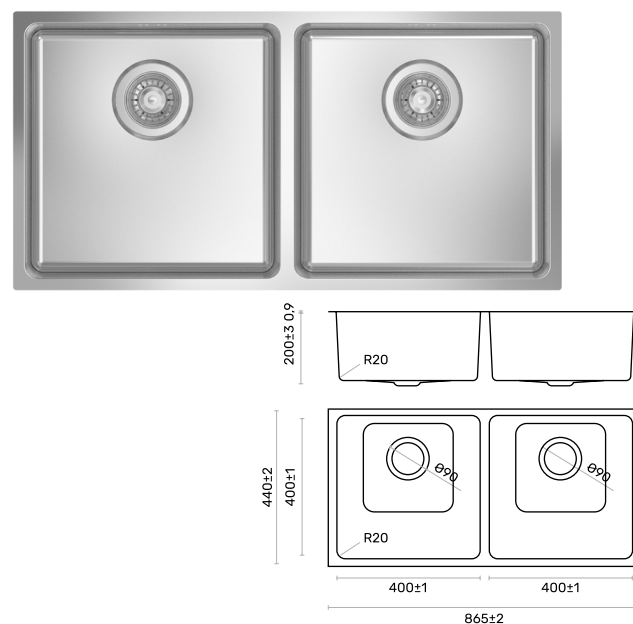

MODELO MODEL	APLICAÇÃO APPLICATION	ACABAMENTO FINISHING	MEDIDA DA PIA SINK MEASURE	PROFUNDIDADE DEPTH	CAIXA BOX	REFERÊNCIA REFERENCE
SMART PP R20 765 765X440	Apl. por baixo Undermounted	INOX STAINLESS STEEL	R20 400X400/400X300	200	01 UN	LLSPP76512
SMART PP R20 865 865X440	Apl. por baixo Undermounted	INOX STAINLESS STEEL	R20 400X400	200	01 UN	LLSPP86512

SUBLIME R10 400

R10 400 SUBLIME

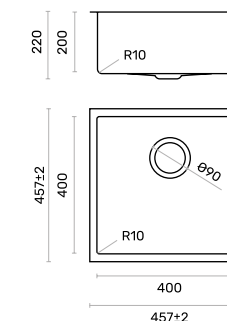

MODELO MODEL	APLICAÇÃO APPLICATION	ACABAMENTO FINISHING	MEDIDA DA PIA SINK MEASURE	PROF. INTERIOR INTERIOR DEPTH	CAIXA BOX	REFERÊNCIA REFERENCE
SUBLIME R10 400 457X457	Apl. por baixo Undermounted	BRANCO WHITE PRETO BLACK	R10 400X400	200	01 UN	LLCS004003 LLCS004009

SUBLIME R10 500

R10 500 SUBLIME

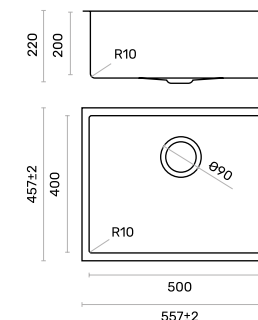

MODELO MODEL	APLICAÇÃO APPLICATION	ACABAMENTO FINISHING	MEDIDA DA PIA SINK MEASURE	PROF. INTERIOR INTERIOR DEPTH	CAIXA BOX	REFERÊNCIA REFERENCE
SUBLIME R10 500 557X457	Apl. por baixo Undermounted	BRANCO WHITE PRETO BLACK	R10 500X400	200	01 UN	LLCS005003 LLCS005009

SUBLIME R10 700

R10 700 SUBLIME

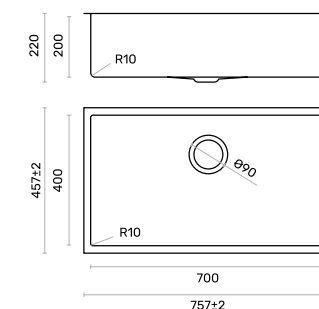

MODELO MODEL	APLICAÇÃO APPLICATION	ACABAMENTO FINISHING	MEDIDA DA PIA SINK MEASURE	PROF. INTERIOR INTERIOR DEPTH	CAIXA BOX	REFERÊNCIA REFERENCE
SUBLIME R10 700 757X457	Apl. por baixo Undermounted	BRANCO WHITE PRETO BLACK	R10 700X400	200	01 UN	LLCS007003 LLCS007009

LAVA LOUÇAS PHILIN

PHILIN KITCHEN SINKS

PHILIN

COMPOSITO

LAVA LOUÇAS

KITCHEN SINKS

SUBLIME PE

SUBLIME PE

SUBLIME PPE

SUBLIME PPE

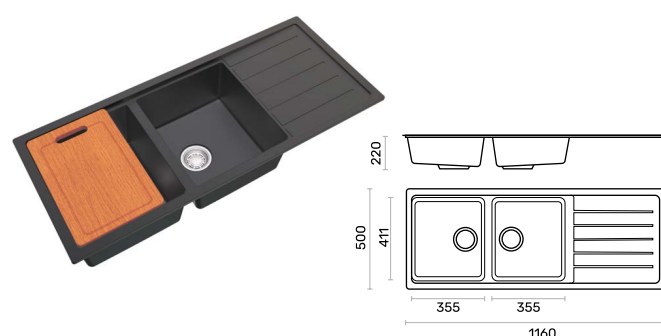
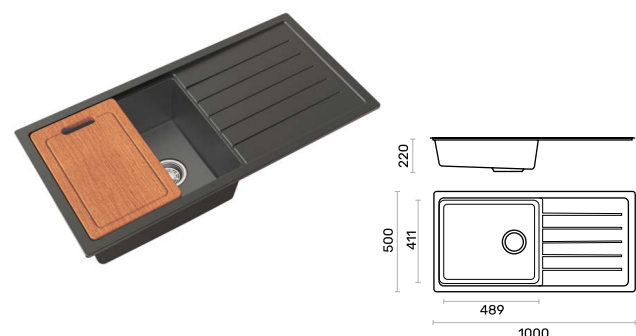

MODELO MODEL	APLICAÇÃO APPLICATION	ACABAMENTO FINISHING	MEDIDA DA PIA SINK MEASURE	PROFUNDIDADE DEPTH	CAIXA BOX	REFERÊNCIA REFERENCE
SUBLIME PE 1000X500	Encastrar Inset	BRANCO WHITE	R10 489x411	220	01 UN	LLCSPE1003
		PRETO BLACK				LLCSPE1009
SUBLIME PPE 1160X500	Encastrar Inset	BRANCO WHITE	R10 355x411	220	01 UN	LLCSPE1203
		PRETO BLACK				LLCSPE1209
TÁBUA DE CORTE CSPE	-	-	426x280x22	-	10 UN	LLCBCSPE67

TAMANHO MÍNIMO DO MÓVEL: 450MM
MINIMUM CABINET SIZE: 450MM

ELEMENT 86

ELEMENT 86

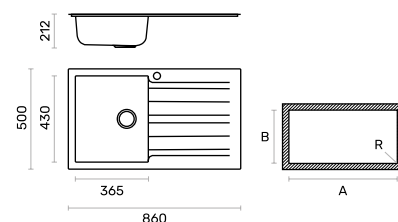

MODELO MODEL	APLICAÇÃO APPLICATION	ACABAMENTO FINISHING	MEDIDAS MEASURES	MEDIDA DA PIA SINK MEASURE	PROFUNDIDADE DEPTH	CAIXA BOX	REFERÊNCIA REFERENCE
ELEMENT 86 860X500	Encastrar Inset	PRETO BLACK	R0 A836 X B472	365X430	212	01 UN	CPE44086

TAMANHO MÍNIMO DO MÓVEL: 450MM
MINIMUM CABINET SIZE: 450MM

M 32001

M 32001

M 13000

M 13000

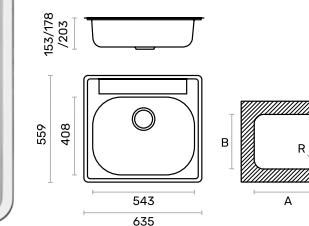
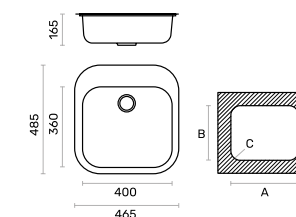

MODELO MODEL	APLICAÇÃO APPLICATION	ACABAMENTO FINISHING	MEDIDAS MEASURES	MEDIDA DA PIA SINK MEASURE	PROFUNDIDADE DEPTH	CAIXA BOX	REFERÊNCIA REFERENCE
M 32001 465X485	Encastrar Inset	POLIDO POLISHED	A445 X B465 X C140	400X360	165	01 UN	E32001
M 13000 635X559	Encastrar Inset	POLIDO POLISHED	A620 x B540	543X408	153	01 UN	E13153
	Apl. por baixo Undermounted						U13153

TAMANHO MÍNIMO DO MÓVEL: 500MM
MINIMUM CABINET SIZE: 500MM

F 16702

F 16702

F 16703

F 16703

F 16704

F 16704

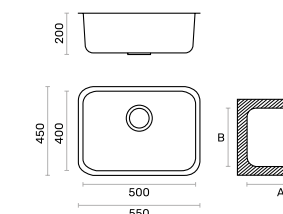
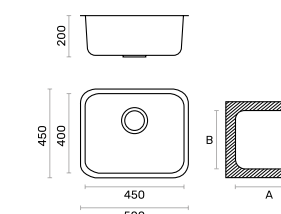
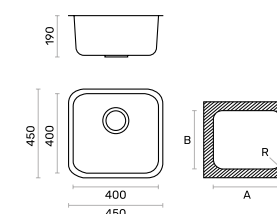

MODELO MODEL	APLICAÇÃO APPLICATION	ACABAMENTO FINISHING	MEDIDAS MEASURES	MEDIDA DA PIA SINK MEASURE	PROFUNDIDADE DEPTH	CAIXA BOX	REFERÊNCIA REFERENCE
F 16702 450X450	Apl. por baixo Undermounted	POLIDO POLISHED	R63 A405 X B405	400x400	190	05 UN	LL70F16702
F 16703 500X450	Apl. por baixo Undermounted		R63 A455 X B405	450x400	200	05 UN	LL70F16703
F 16704 550X450	Apl. por baixo Undermounted		R63 A505 X B405	450x400	200	05 UN	LL70F16704

LAVA LOUÇAS INOX

STAINLESS STEEL KITCHEN SINKS

LAVA LOUÇAS INOX

STAINLESS STEEL KITCHEN SINKS



IBERICO 50
IBERICO 50

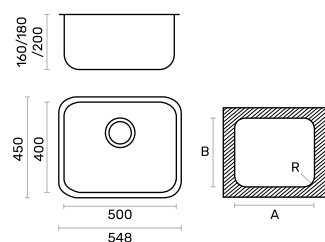

MODELO MODEL	APLICAÇÃO APPLICATION	ACABAMENTO FINISHING	MEDIDAS MEASURES	MEDIDA DA PIA SINK MEASURE	PROFUNDIDADE DEPTH	CAIXA BOX	REFERÊNCIA REFERENCE
IBERICO 50 548X450	Enc. à face/Superfície Flushmounted	● POLIDO POLISHED	R70 A544 X B444 A520 X B420	500X400	160	01 UN	E30004
	Apl. por baixo Undermounted		R56 A492 X B392				U30003
	Enc. à face/Superfície Flushmounted	● POLIDO POLISHED	R70 A544 X B444 A520 X B420	500X400	180	01 UN	E30006
	Apl. por baixo Undermounted		R56 A492 X B392				U30005
	Enc. à face/Superfície Flushmounted	● POLIDO POLISHED	R70 A544 X B444 A520 X B420	500X400	200	01 UN	E30002
	Apl. por baixo Undermounted		R56 A492 X B392				U30001

i TAMANHO MÍNIMO DO MÓVEL: 600MM
MINIMUM CABINET SIZE: 600MM



IBERICO 45
IBERICO 45

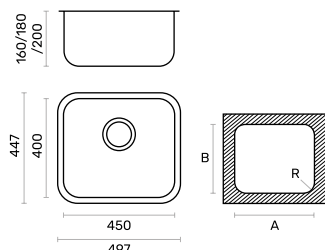

MODELO MODEL	APLICAÇÃO APPLICATION	ACABAMENTO FINISHING	MEDIDAS MEASURES	MEDIDA DA PIA SINK MEASURE	PROFUNDIDADE DEPTH	CAIXA BOX	REFERÊNCIA REFERENCE
IBERICO 45 497X447	Enc. à face/Superfície Flushmounted	● POLIDO POLISHED	R70 A494 X B444 A470 X B420	450X400	160	01 UN	E33004
	Apl. por baixo Undermounted		R56 A442 X B392				U33003
	Enc. à face/Superfície Flushmounted	● POLIDO POLISHED	R70 A494 X B444 A470 X B420	450X400	180	01 UN	E33006
	Apl. por baixo Undermounted		R56 A442 X B392				U33005
	Enc. à face/Superfície Flushmounted	● POLIDO POLISHED	R70 A494 X B444 A470 X B420	450X400	200	01 UN	E33002
	Apl. por baixo Undermounted		R56 A442 X B392				U33001

i TAMANHO MÍNIMO DO MÓVEL: 500MM
MINIMUM CABINET SIZE: 500MM

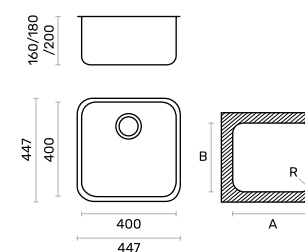

IBERICO 40
IBERICO 40



MODELO MODEL	APLICAÇÃO APPLICATION	ACABAMENTO FINISHING	MEDIDAS MEASURES	MEDIDA DA PIA SINK MEASURE	PROFUNDIDADE DEPTH	CAIXA BOX	REFERÊNCIA REFERENCE
IBERICO 40 447X447	Enc. à face/Superfície Flushmounted	● POLIDO POLISHED	R77 A444 X B444 A420 X B420	400X400	160	01 UN	E25004
	Apl. por baixo Undermounted		R56 A392 X B392				U25003
	Enc. à face/Superfície Flushmounted	● POLIDO POLISHED	R77 A444 X B444 A420 X B420	400X400	180	01 UN	E25006
	Apl. por baixo Undermounted		R56 A392 X B392				U25005
	Enc. à face/Superfície Flushmounted	● POLIDO POLISHED	R77 A444 X B444 A420 X B420	400X400	200	01 UN	E25002
	Apl. por baixo Undermounted		R56 A392 X B392				U25001

i TAMANHO MÍNIMO DO MÓVEL: 500MM
MINIMUM CABINET SIZE: 500MM

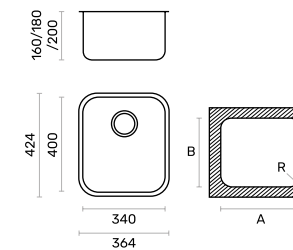

IBERICO 34
IBERICO 34



MODELO MODEL	APLICAÇÃO APPLICATION	ACABAMENTO FINISHING	MEDIDAS MEASURES	MEDIDA DA PIA SINK MEASURE	PROFUNDIDADE DEPTH	CAIXA BOX	REFERÊNCIA REFERENCE
IBERICO 34 364X424	Enc. à face/Superfície Flushmounted	● POLIDO POLISHED	R70 A384 X B444 A360 X B420	340X400	160	01 UN	E31004
	Apl. por baixo Undermounted		R56 A332 X B392				U31003
	Enc. à face/Superfície Flushmounted	● POLIDO POLISHED	R70 A384 X B444 A360 X B420	340X400	180	01 UN	E31006
	Apl. por baixo Undermounted		R56 A332 X B392				U31005
	Enc. à face/Superfície Flushmounted	● POLIDO POLISHED	R70 A384 X B444 A360 X B420	340X400	200	01 UN	E31002
	Apl. por baixo Undermounted		R56 A332 X B392				U31001

i TAMANHO MÍNIMO DO MÓVEL: 450MM
MINIMUM CABINET SIZE: 450MM

LAVA LOUÇAS INOX

STAINLESS STEEL KITCHEN SINKS

M 5000

M 5000

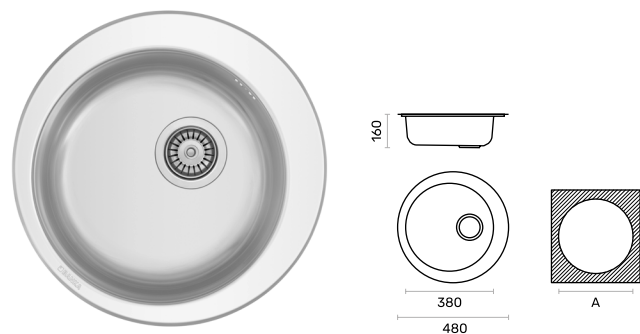

i TAMANHO MÍNIMO DO MÓVEL: 600MM
MINIMUM CABINET SIZE: 600MM

MODELO MODEL	APLICAÇÃO APPLICATION	ACABAMENTO FINISHING	MEDIDAS MEASURES	MEDIDA DA PIA SINK MEASURE	PROFUNDIDADE DEPTH	CAIXA BOX	REFERÊNCIA REFERENCE
M 5000 Ø480	Encastrar Inset	POLIDO POLISHED	AØ455	Ø380	160	01 UN	E5160
M 8160 Ø450	Encastrar Inset	POLIDO POLISHED	AØ425	Ø380	160	01 UN	E8160
	Apl. por baixo Undermounted		AØ380				U8160

M 8160

M 8160

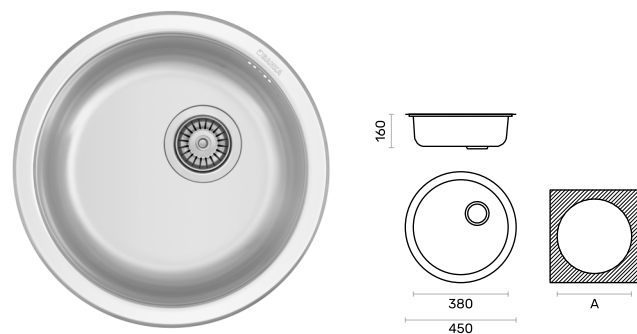

i TAMANHO MÍNIMO DO MÓVEL: 450MM
MINIMUM CABINET SIZE: 450MM

M 9046

M 9046

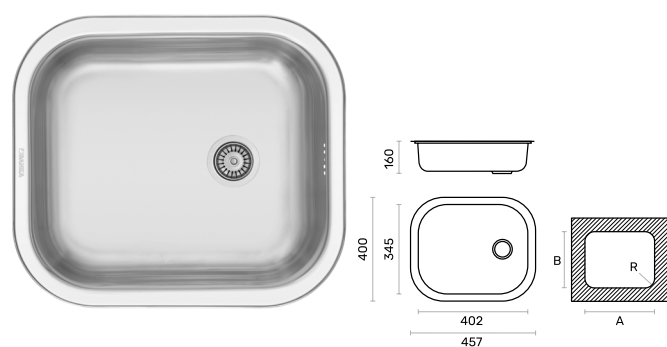

i TAMANHO MÍNIMO DO MÓVEL: 450MM
MINIMUM CABINET SIZE: 450MM

MODELO MODEL	APLICAÇÃO APPLICATION	ACABAMENTO FINISHING	MEDIDAS MEASURES	MEDIDA DA PIA SINK MEASURE	PROFUNDIDADE DEPTH	CAIXA BOX	REFERÊNCIA REFERENCE
M 9046 457X400	Encastrar Inset	POLIDO POLISHED	R103 A438 X B380	402X345	160	01 UN	E9046
	Apl. por baixo Undermounted		R95 A402 X B349				U9046
M 9054 542X402	Encastrar Inset	POLIDO POLISHED	R103 A518 X B380	482X345	160	01 UN	E9054
	Apl. por baixo Undermounted		R95 A482 X B342				U9054

i TAMANHO MÍNIMO DO MÓVEL: 600MM
MINIMUM CABINET SIZE: 600MM

LAVA LOUÇAS INOX

STAINLESS STEEL KITCHEN SINKS

BALANCE 100-15

BALANCE 100-15

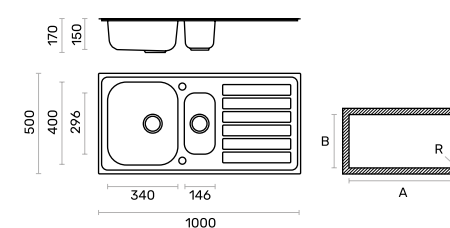

MODELO MODEL	APLICAÇÃO APPLICATION	ACABAMENTO FINISHING	MEDIDAS MEASURES	MEDIDA DA PIA SINK MEASURE	PROFUNDIDADE DEPTH	CAIXA BOX	REFERÊNCIA REFERENCE
BALANCE 100-15 1000X500	Encastrar Inset	POLIDO POLISHED	R10	A980 X B480	340X400/146X296	170/150	01 UN E42102

i TAMANHO MÍNIMO DO MÓVEL: 600MM
MINIMUM CABINET SIZE: 600MM

BALANCE 80-1

BALANCE 80-1

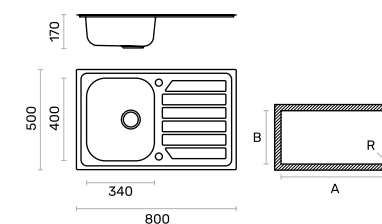

MODELO MODEL	APLICAÇÃO APPLICATION	ACABAMENTO FINISHING	MEDIDAS MEASURES	MEDIDA DA PIA SINK MEASURE	PROFUNDIDADE DEPTH	CAIXA BOX	REFERÊNCIA REFERENCE
BALANCE 80-1 800X500	Encastrar Inset	POLIDO POLISHED	R10	A780 X B480	340X400	170	E42080
		MATE MATTE					E42080NP

i TAMANHO MÍNIMO DO MÓVEL: 450MM
MINIMUM CABINET SIZE: 450MM

BALANCE 80-2

BALANCE 80-2

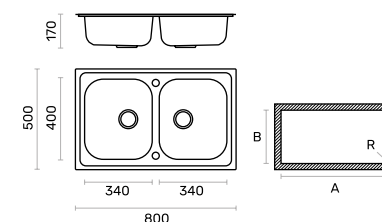

MODELO MODEL	APLICAÇÃO APPLICATION	ACABAMENTO FINISHING	MEDIDAS MEASURES	MEDIDA DA PIA SINK MEASURE	PROFUNDIDADE DEPTH	CAIXA BOX	REFERÊNCIA REFERENCE
BALANCE 80-2 800X500	Encastrar Inset	POLIDO POLISHED	R10	A780 X B480	340X400	170	E42082
		MATE MATTE					E42082NP

i TAMANHO MÍNIMO DO MÓVEL: 800MM
MINIMUM CABINET SIZE: 800MM

LAVA LOUÇAS INOX

STAINLESS STEEL KITCHEN SINKS



BALANCE 120
BALANCE 120

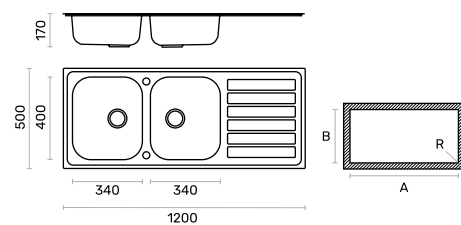

MODELO MODEL	APLICAÇÃO APPLICATION	ACABAMENTO FINISHING	MEDIDAS MEASURES	MEDIDA DA PIA SINK MEASURE	PROFUNDIDADE DEPTH	CAIXA BOX	REFERÊNCIA REFERENCE
BALANCE 120 1200X500	Encastrar Inset	POLIDO POLISHED	R10	A1180 X B480	340X400	170	E42120
		MATE MATTE					E42120NP

i TAMANHO MÍNIMO DO MÓVEL: 800MM
MINIMUM CABINET SIZE: 800MM



BALANCE 100-50
BALANCE 100-50

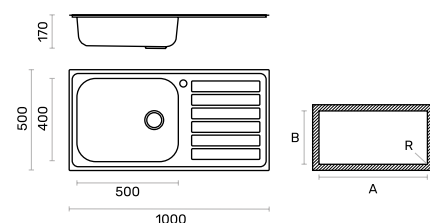

MODELO MODEL	APLICAÇÃO APPLICATION	ACABAMENTO FINISHING	MEDIDAS MEASURES	MEDIDA DA PIA SINK MEASURE	PROFUNDIDADE DEPTH	CAIXA BOX	REFERÊNCIA REFERENCE
BALANCE 100-50 1000X500	Encastrar Inset	POLIDO POLISHED	R10	A980 X B480	500X400	170	01 UN E42100

i TAMANHO MÍNIMO DO MÓVEL: 800MM
MINIMUM CABINET SIZE: 800MM



BALANCE 100-34
BALANCE 100-34

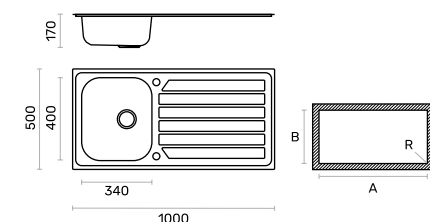

MODELO MODEL	APLICAÇÃO APPLICATION	ACABAMENTO FINISHING	MEDIDAS MEASURES	MEDIDA DA PIA SINK MEASURE	PROFUNDIDADE DEPTH	CAIXA BOX	REFERÊNCIA REFERENCE
BALANCE 100-34 1000X500	Encastrar Inset	POLIDO POLISHED	R10	A980 X B480	340X400	170	E42101
		MATE MATTE					E42101NP

i TAMANHO MÍNIMO DO MÓVEL: 450MM
MINIMUM CABINET SIZE: 450MM

LAVA LOUÇAS INOX

STAINLESS STEEL KITCHEN SINKS

M 6045
M 6045

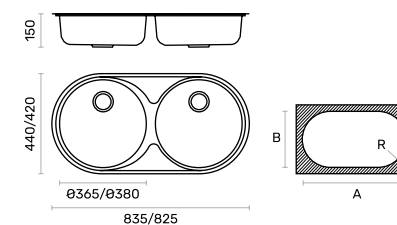

MODELO MODEL	APLICAÇÃO APPLICATION	ACABAMENTO FINISHING	MEDIDAS MEASURES	MEDIDA DA PIA SINK MEASURE	PROFUNDIDADE DEPTH	CAIXA BOX	REFERÊNCIA REFERENCE
M 6045 835X440	Encastrar Inset	POLIDO POLISHED	R208	A811 X B416	150	01 UN	E6045
		MATE MATTE					E6045NP
M 6045 835X440	Apl. por baixo Undermounted	POLIDO POLISHED	R190	A785 X B380	150	01 UN	U6045
		MATE MATTE					U6045NP

i TAMANHO MÍNIMO DO MÓVEL: 800MM
MINIMUM CABINET SIZE: 800MM

M 7045
M 7045

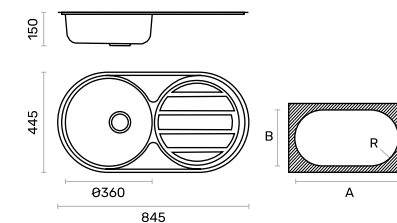

MODELO MODEL	APLICAÇÃO APPLICATION	ACABAMENTO FINISHING	MEDIDAS MEASURES	MEDIDA DA PIA SINK MEASURE	PROFUNDIDADE DEPTH	CAIXA BOX	REFERÊNCIA REFERENCE
M 7045 845X445	Encastrar Inset	POLIDO POLISHED	R213,5	A820 X B427	150	01 UN	E7045
		MATE MATTE					E7045NP

i TAMANHO MÍNIMO DO MÓVEL: 600MM
MINIMUM CABINET SIZE: 600MM

M 11000
M 11000

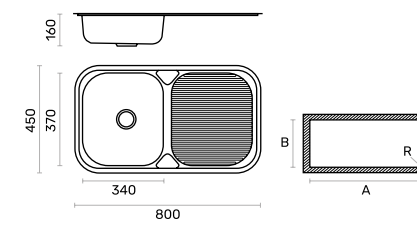

MODELO MODEL	APLICAÇÃO APPLICATION	ACABAMENTO FINISHING	MEDIDAS MEASURES	MEDIDA DA PIA SINK MEASURE	PROFUNDIDADE DEPTH	CAIXA BOX	REFERÊNCIA REFERENCE
M 11000 800X450	Encastrar Inset	POLIDO POLISHED	R130	A778 X B428	340X370	160	01 UN E11084

i TAMANHO MÍNIMO DO MÓVEL: 500MM
MINIMUM CABINET SIZE: 500MM

LAVA LOUÇAS INOX

STAINLESS STEEL KITCHEN SINKS



F 16720
F 16720

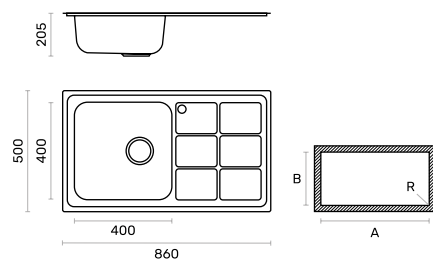

MODELO MODEL	APLICAÇÃO APPLICATION	ACABAMENTO FINISHING	MEDIDAS MEASURES	MEDIDA DA PIA SINK MEASURE	PROFUNDIDADE DEPTH	CAIXA BOX	REFERÊNCIA REFERENCE
F 16720 860X500	Encastrar Inset	POLIDO POLISHED	R10 A845 X B485	400X400	205	01 UN	LL70F16720

LAVA LOUÇAS INOX

STAINLESS STEEL KITCHEN SINKS

MORFUS DEEP
MORFUS DEEP

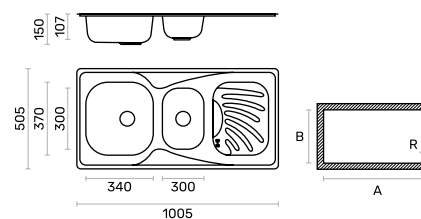

MODELO MODEL	APLICAÇÃO APPLICATION	ACABAMENTO FINISHING	MEDIDAS MEASURES	MEDIDA DA PIA SINK MEASURE	PROFUNDIDADE DEPTH	CAIXA BOX	REFERÊNCIA REFERENCE
MORFUS DEEP 1005X505	Encastrar Inset	POLIDO POLISHED	R25 A970 X B480	340X370/300X300	150/107	01 UN	E18002

i TAMANHO MÍNIMO DO MÓVEL: 800MM
MINIMUM CABINET SIZE: 800MM

F 16742
F 16742

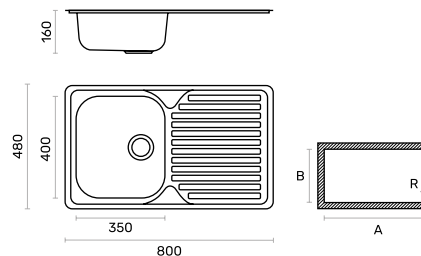

MODELO MODEL	APLICAÇÃO APPLICATION	ACABAMENTO FINISHING	MEDIDAS MEASURES	MEDIDA DA PIA SINK MEASURE	PROFUNDIDADE DEPTH	CAIXA BOX	REFERÊNCIA REFERENCE
F 16742 800X480	Encastrar Inset	POLIDO POLISHED	R10 A780 X B460	350X400	160	05 UN	LL70F16742

F 16743
F 16743

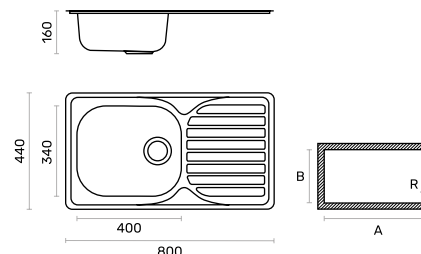

MODELO MODEL	APLICAÇÃO APPLICATION	ACABAMENTO FINISHING	MEDIDAS MEASURES	MEDIDA DA PIA SINK MEASURE	PROFUNDIDADE DEPTH	CAIXA BOX	REFERÊNCIA REFERENCE
F 16743 800X440	Encastrar Inset	POLIDO POLISHED	R10 A780 X B420	400X350	160	05 UN	LL70F16743

CATÁLOGO GERAL • GENERAL CATALOGUE



M 26000
M 26000

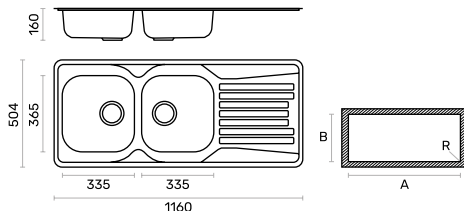

MODELO MODEL	APLICAÇÃO APPLICATION	ACABAMENTO FINISHING	MEDIDAS MEASURES	MEDIDA DA PIA SINK MEASURE	PROFUNDIDADE DEPTH	CAIXA BOX	REFERÊNCIA REFERENCE
M 26000 1160X504	Encastrar Inset	POLIDO POLISHED MATE MATTE	R25 A1130 X B480 A1120 X B470	335X365	160	01 UN	E26001 E26001NP

i TAMANHO MÍNIMO DO MÓVEL: 800MM
MINIMUM CABINET SIZE: 800MM

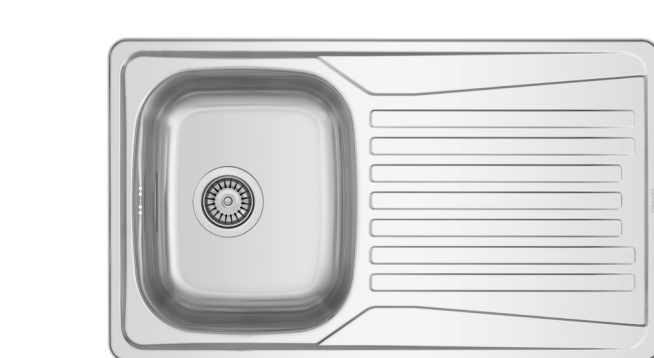

M 28000
M 28000

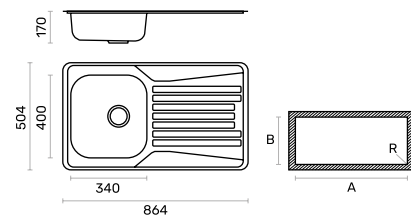

MODELO MODEL	APLICAÇÃO APPLICATION	ACABAMENTO FINISHING	MEDIDAS MEASURES	MEDIDA DA PIA SINK MEASURE	PROFUNDIDADE DEPTH	CAIXA BOX	REFERÊNCIA REFERENCE
M 28000 864X504	Encastrar Inset	POLIDO POLISHED MATE MATTE	R25 A830 X B480 A820 X B470	340X400	170	01 UN	E28001 E28001NP

i TAMANHO MÍNIMO DO MÓVEL: 450MM
MINIMUM CABINET SIZE: 450MM

CATÁLOGO GERAL • GENERAL CATALOGUE

LAVA LOUÇAS INOX

STAINLESS STEEL KITCHEN SINKS

LAVA LOUÇAS INOX

STAINLESS STEEL KITCHEN SINKS



M 14000
M 14000

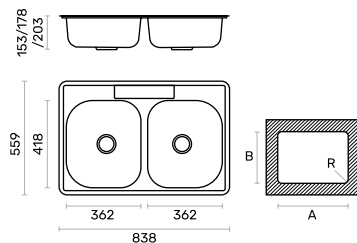

MODELO MODEL	APLICAÇÃO APPLICATION	ACABAMENTO FINISHING	MEDIDAS MEASURES	MEDIDA DA PIA SINK MEASURE	PROFUNDIDADE DEPTH	CAIXA BOX	REFERÊNCIA REFERENCE
M 14000 838X559	Encastrar Inset	● POLIDO POLISHED	R20	A822 X B540	362X418	01 UN	153
							178
							203
	Apl. por baixo Undermounted	● POLIDO POLISHED	R118	A759 X B415	362X418	01 UN	153
							178
							203

TAMANHO MÍNIMO DO MÓVEL: 800MM
MINIMUM CABINET SIZE: 800MM



M 21000
M 21000

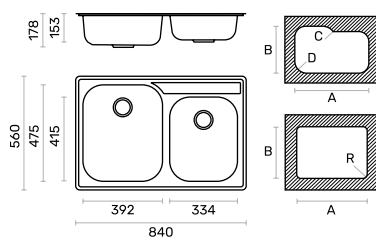

MODELO MODEL	APLICAÇÃO APPLICATION	ACABAMENTO FINISHING	MEDIDAS MEASURES	MEDIDA DA PIA SINK MEASURE	PROFUNDIDADE DEPTH	CAIXA BOX	REFERÊNCIA REFERENCE	
M 21000 840X560	Encastrar Inset	● POLIDO POLISHED	R20	A825 X B545	392X475/334X415	01 UN	E21178	
							● MATE MATTE	E21178NP
		● POLIDO POLISHED	R20	A825 X B545	392X475/334X415	203/178	01 UN	E21203
								● MATE MATTE
	Apl. por baixo Undermounted	● POLIDO POLISHED	-	A750 X B475 CR20 X DR1100	392X475/334X415	178/153	01 UN	U21178
								● MATE MATTE
	● POLIDO POLISHED	-	A750 X B475 CR20 X DR1100	392X475/334X415	203/178	01 UN	U21203	
							● MATE MATTE	U21203NP

TAMANHO MÍNIMO DO MÓVEL: 800MM
MINIMUM CABINET SIZE: 800MM

M 1081
M 1081

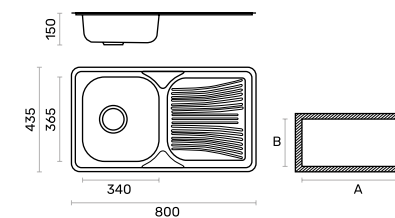

MODELO MODEL	APLICAÇÃO APPLICATION	ACABAMENTO FINISHING	MEDIDAS MEASURES	MEDIDA DA PIA SINK MEASURE	PROFUNDIDADE DEPTH	CAIXA BOX	REFERÊNCIA REFERENCE
M 1081 800X435	Encastrar Inset	● POLIDO POLISHED	R25	A778 X B420	340X365	01 UN	E1081
		● MATE MATTE					E1081NP

TAMANHO MÍNIMO DO MÓVEL: 450MM
MINIMUM CABINET SIZE: 450MM

M 2081
M 2081

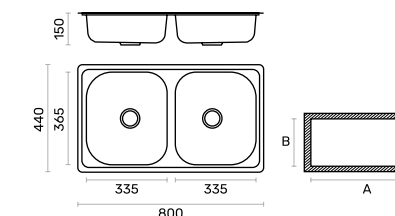

MODELO MODEL	APLICAÇÃO APPLICATION	ACABAMENTO FINISHING	MEDIDAS MEASURES	MEDIDA DA PIA SINK MEASURE	PROFUNDIDADE DEPTH	CAIXA BOX	REFERÊNCIA REFERENCE
M 2081 800X440	Encastrar Inset	● POLIDO POLISHED	R25	A780 X B420	335X365	01 UN	E2081

TAMANHO MÍNIMO DO MÓVEL: 450MM
MINIMUM CABINET SIZE: 450MM

M 10000
M 10000

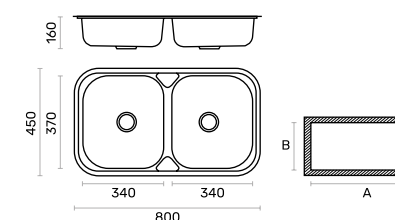

MODELO MODEL	APLICAÇÃO APPLICATION	ACABAMENTO FINISHING	MEDIDAS MEASURES	MEDIDA DA PIA SINK MEASURE	PROFUNDIDADE DEPTH	CAIXA BOX	REFERÊNCIA REFERENCE
M 10000 800X450	Encastrar Inset	● POLIDO POLISHED	R130	A778 X B428	340X370	01 UN	E10084

TAMANHO MÍNIMO DO MÓVEL: 900MM
MINIMUM CABINET SIZE: 900MM

LAVA LOUÇAS INOX

STAINLESS STEEL KITCHEN SINKS

M 3120
M 3120

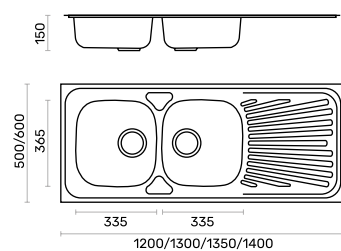

MODELO MODEL	APLICAÇÃO APPLICATION	ACABAMENTO FINISHING	MEDIDA MEASURE	MEDIDA DA PIA SINK MEASURE	PROFUNDIDADE DEPTH	CAIXA BOX	REFERÊNCIA REFERENCE
M 3120	Pousar Drop in	● MATE MATTE	1200X500				N3120NP
			1300X500	335X365	150	01 UN	N3130NP
			1350X500				N3135NP
			1400X500				N3140NP
	Pousar Drop in	● MATE MATTE	1200X600				L3120NP
			1300X600	335X365	150	01 UN	L3130NP
			1350X600				L3135NP
			1400X600				L3140NP
	Encastrar Inset	● MATE MATTE	1300X510				E3130NP
			1350X510	335X365	150	01 UN	E3135NP
			1400X510				E3140NP

M 1080
M 1080

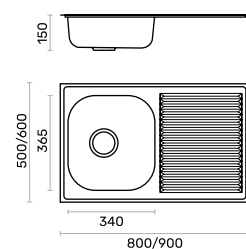

MODELO MODEL	APLICAÇÃO APPLICATION	ACABAMENTO FINISHING	MEDIDA MEASURE	MEDIDA DA PIA SINK MEASURE	PROFUNDIDADE DEPTH	CAIXA BOX	REFERÊNCIA REFERENCE
M 1080	Pousar Drop in	● MATE MATTE	800X500				N1080NP
			900X500	340X365	150	01 UN	N1090NP
			900X600				L1090NP
	Encastrar Inset	● MATE MATTE	900X510	340X365	150	01 UN	E1090NP

LAVA LOUÇAS INOX

STAINLESS STEEL KITCHEN SINKS

M 1100
M 1100

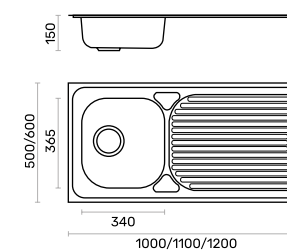

MODELO MODEL	APLICAÇÃO APPLICATION	ACABAMENTO FINISHING	MEDIDA MEASURE	MEDIDA DA PIA SINK MEASURE	PROFUNDIDADE DEPTH	CAIXA BOX	REFERÊNCIA REFERENCE
M 1100	Pousar Drop in	● MATE MATTE	1000X500				N1100NP
			1100X500	340X365	150	01 UN	N1110NP
			1200X500				N1120NP
			1000X600				L1100NP
	Pousar Drop in	● MATE MATTE	1100X600	340X365	150	01 UN	L1110NP
			1200X600				L1120NP
			Encastrar Inset	● MATE MATTE	1200X510	340X365	150

M 2080
M 2080

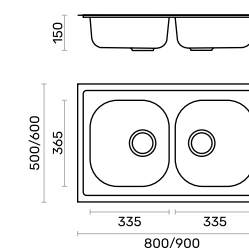

MODELO MODEL	APLICAÇÃO APPLICATION	ACABAMENTO FINISHING	MEDIDA MEASURE	MEDIDA DA PIA SINK MEASURE	PROFUNDIDADE DEPTH	CAIXA BOX	REFERÊNCIA REFERENCE
M 2080	Pousar Drop in	● MATE MATTE	800X500				N2080NP
			900X500	335X365	150	01 UN	N2090NP
			800X600				L2080NP
	Encastrar Inset	● MATE MATTE	900X600				L2090NP
			900X510	335X365	150	01 UN	E2090NP

MISTURADORAS PHILIN

PHILIN FAUCETS

PHILIN

PHILIN

MISTURADORAS PHILIN

PHILIN FAUCETS



MONTANA

MONTANA

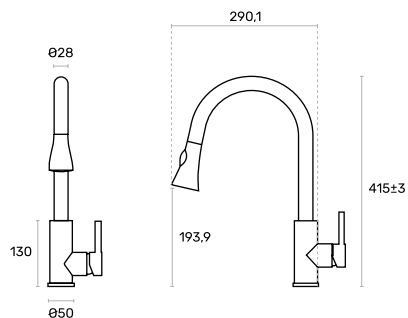

MODELO MODEL	ACABAMENTO FINISHING	MEDIDAS MEASURES	CAIXA BOX	REFERÊNCIA REFERENCE
MONTANA	● INOX STAINLESS STEEL	290.1X415±3	01 UN	K530MPH099



ARIZONA

ARIZONA

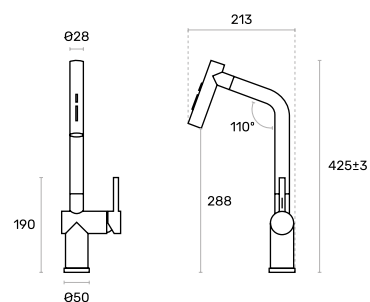

MODELO MODEL	ACABAMENTO FINISHING	MEDIDAS MEASURES	CAIXA BOX	REFERÊNCIA REFERENCE
ARIZONA	● INOX STAINLESS STEEL	213X425±3	01 UN	K530MPH128
	● PRETO BLACK	213X425±3	01 UN	K53MPH128S
	● PVD ROSA DOURADO PVD GOLDEN ROSE	213X425±3	01 UN	K53MPH128S



YORK

YORK

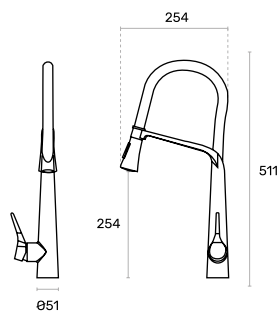

MODELO MODEL	ACABAMENTO FINISHING	MEDIDAS MEASURES	CAIXA BOX	REFERÊNCIA REFERENCE
YORK	● PRETO BLACK	254X511	01 UN	K53MPH137S
	● PVD ROSA DOURADO PVD GOLDEN ROSE	254X511	01 UN	K53MPH137S

FLORIDA

FLORIDA

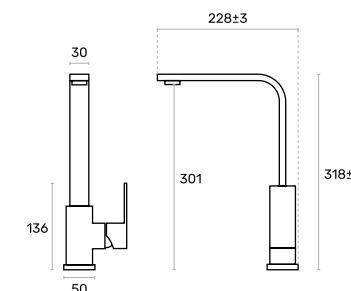

MODELO MODEL	ACABAMENTO FINISHING	MEDIDAS MEASURES	CAIXA BOX	REFERÊNCIA REFERENCE
FLORIDA	● INOX STAINLESS STEEL	228±3X318±3	01 UN	K530MPH003
	● PRETO BLACK	228±3X318±3	01 UN	K53MPH003B

COLORADO

COLORADO

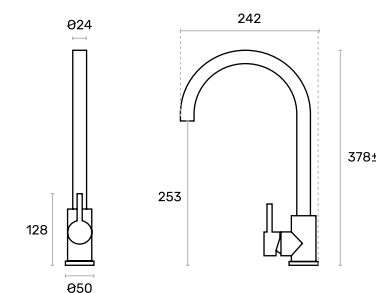

MODELO MODEL	ACABAMENTO FINISHING	MEDIDAS MEASURES	CAIXA BOX	REFERÊNCIA REFERENCE
COLORADO	● INOX STAINLESS STEEL	242X378±3	01 UN	K530MPH106
	● PRETO BLACK	242X378±3	01 UN	K53MPH106B

INDIANA

INDIANA

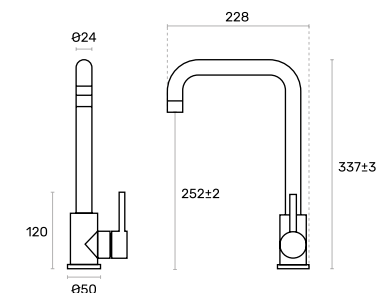

MODELO MODEL	ACABAMENTO FINISHING	MEDIDAS MEASURES	CAIXA BOX	REFERÊNCIA REFERENCE
INDIANA	● INOX STAINLESS STEEL	228X337±3	01 UN	K530MPH104



DAKOTA
DAKOTA

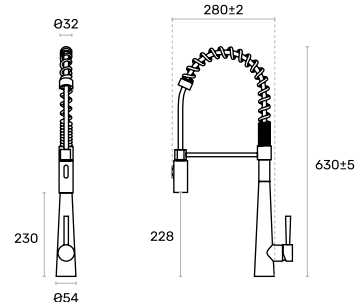

PHILIN

MODELO MODEL	ACABAMENTO FINISHING	MEDIDAS MEASURES	CAIXA BOX	REFERÊNCIA REFERENCE
DAKOTA	● INOX STAINLESS STEEL	280±2X630±5	01 UN	K530MPH096

M221152
M221152

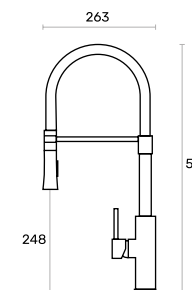

M221122
M221122

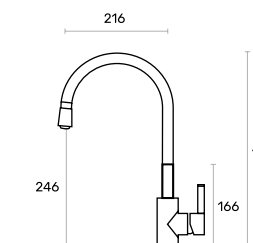

MODELO MODEL	ACABAMENTO FINISHING	MEDIDAS MEASURES	CAIXA BOX	REFERÊNCIA REFERENCE
M221152	● CROMADO CHROME ● PRETO BLACK	263X584	01 UN	K53M221152
M221122	● CROMADO CHROME ● PRETO BLACK	216X401	01 UN	K53M221122

M14022
M14022

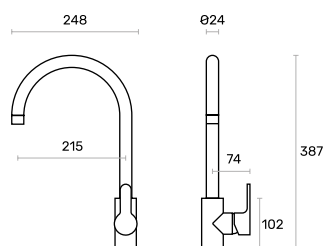

M22110
M22110

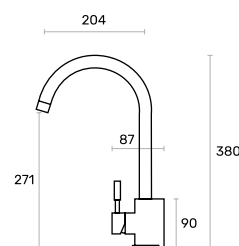

MODELO MODEL	ACABAMENTO FINISHING	MEDIDAS MEASURES	CAIXA BOX	REFERÊNCIA REFERENCE
M14022	● CROMADO CHROME	248X387	01 UN	K530M14022
M22110	● INOX STAINLESS STEEL	204X380	01 UN	K530M22110

M22105
M22105

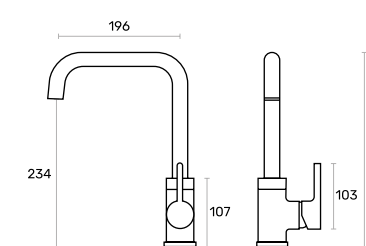

M22105B
M22105B

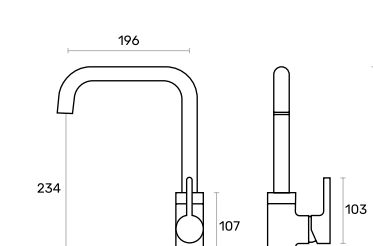

MODELO MODEL	ACABAMENTO FINISHING	MEDIDAS MEASURES	CAIXA BOX	REFERÊNCIA REFERENCE
M22105	● CROMADO CHROME	196X307	01 UN	K530M22105
M22105B	● PRETO BLACK	196X307	01 UN	K53M22105B