

08

DOBRADIÇAS  
HINGES

---

**138** DOBRADIÇAS FB  
FB HINGES

---

**142** DOBRADIÇAS IN  
IN HINGES

---

**144** DOBRADIÇAS DTC  
DTC HINGES

---

**147** DOBRADIÇA KIMANA  
KIMANA HINGE

---

**147** DOBRADIÇA GRASS  
GRASS HINGE

**DOBRADIÇA EE**  
EE HINGE

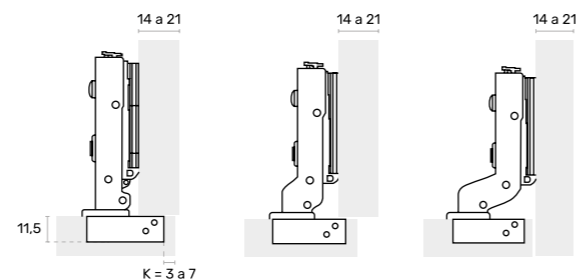

MODELO MODEL	ESPESSURA DA PLACA DOOR THICKNESS	ÂNGULO ANGLE	DIÂMETRO DIAMETER	CAIXA BOX	REFERÊNCIA REFERENCE	
<b>DOBRADIÇA EE</b>	C=0	14-21	105°	Ø35	100 UN	<b>D100000120</b>
	C=8					<b>D100000220</b>
	C=15					<b>D100000320</b>

**i** COM AMORTECEDOR  
SOFT CLOSE

**DOBRADIÇA TT**  
TT HINGE

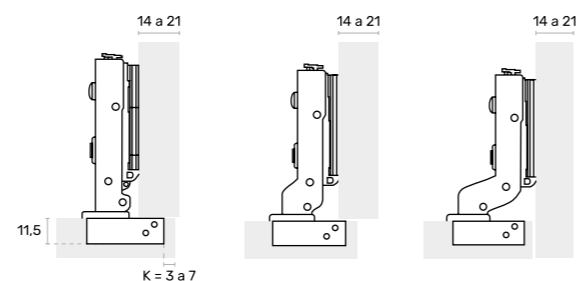

MODELO MODEL	ESPESSURA DA PLACA DOOR THICKNESS	ÂNGULO ANGLE	DIÂMETRO DIAMETER	CAIXA BOX	REFERÊNCIA REFERENCE	
<b>DOBRADIÇA TT</b>	C=0	14-21	105°	Ø35	100 UN	<b>D100000420</b>
	C=8					<b>D100000520</b>
	C=15					<b>D100000620</b>

**i** COM AMORTECEDOR 3D  
3D SOFT CLOSE

<b>DOBRADIÇA TT 2W</b>	C=0	14-21	105°	Ø35	100 UN	<b>D100000720</b>
	C=8					<b>D100000820</b>
	C=15					<b>D100000920</b>

**i** 2 POSIÇÕES COM AMORTECEDOR 3D  
2 WAY 3D SOFT CLOSE

**DOBRADIÇA TTBC**  
TTBC HINGE

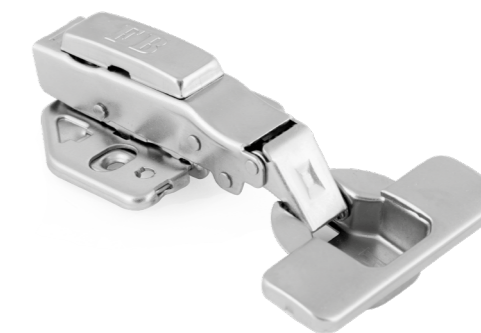
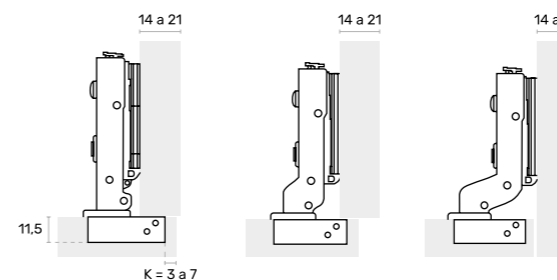

MODELO MODEL	ESPESSURA DA PLACA DOOR THICKNESS	ÂNGULO ANGLE	DIÂMETRO DIAMETER	CAIXA BOX	REFERÊNCIA REFERENCE	
<b>DOBRADIÇA TTBC</b>	C=0	14-21	105°	Ø35	100 UN	<b>D100001320</b>
	C=8					<b>D100001420</b>
	C=15					<b>D100001520</b>

**i** COM AMORTECEDOR 3D  
3D SOFT CLOSE

<b>DOBRADIÇA TTBC 2W</b>	C=0	14-21	105°	Ø35	100 UN	<b>D100001620</b>
	C=8					<b>D100001720</b>
	C=15					<b>D100001820</b>

**i** 2 POSIÇÕES COM AMORTECEDOR 3D  
2 WAY 3D SOFT CLOSE

**DOBRADIÇA TTMD**  
TTMD HINGE

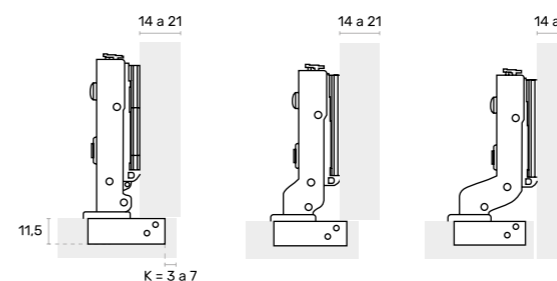

MODELO MODEL	ESPESSURA DA PLACA DOOR THICKNESS	ÂNGULO ANGLE	DIÂMETRO DIAMETER	CAIXA BOX	REFERÊNCIA REFERENCE	
<b>DOBRADIÇA TTMD</b>	C=0	14-21	105°	Ø35	200 UN	<b>D100010420</b>
	C=8					<b>D100010520</b>
	C=15					<b>D100010620</b>

**i** COM AMORTECEDOR 3D  
3D SOFT CLOSE

<b>DOBRADIÇA TTMD 2W</b>	C=0	14-21	105°	Ø35	200 UN	<b>D100011420</b>
	C=8					<b>D100011520</b>
	C=15					<b>D100011620</b>

**i** 2 POSIÇÕES COM AMORTECEDOR 3D  
2 WAY 3D SOFT CLOSE

# DOBRADIÇAS FB

FB HINGES

# DOBRADIÇAS FB

FB HINGES

## DOBRADIÇA 25°

25° HINGE

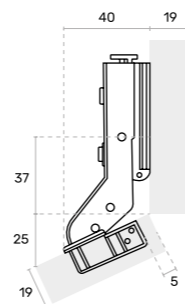

MODELO MODEL	ÂNGULO ANGLE	ESPESSURA DA PLACA DOOR THICKNESS	DIÂMETRO DIAMETER	CAIXA BOX	REFERÊNCIA REFERENCE
<b>DOBRADIÇA 25°</b>	25°	14-21	Ø35	100 UN	<b>D100001920</b>

**i** COM AMORTECEDOR  
SOFT CLOSE

## DOBRADIÇA 30° 3D

30° 3D HINGE

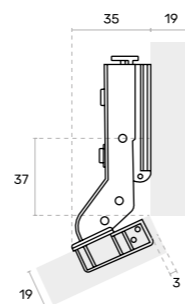

MODELO MODEL	ESPESSURA DA PLACA DOOR THICKNESS	ÂNGULO ANGLE	DIÂMETRO DIAMETER	CAIXA BOX	REFERÊNCIA REFERENCE
<b>DOBRADIÇA 30°</b>	14-21	30°	Ø35	100 UN	<b>D100010820</b>

**i** COM AMORTECEDOR  
SOFT CLOSE

## DOBRADIÇA 45°

45° HINGE

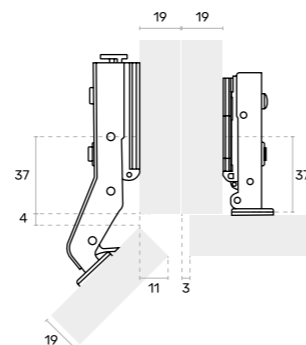

MODELO MODEL	ESPESSURA DA PLACA DOOR THICKNESS	ÂNGULO ANGLE	DIÂMETRO DIAMETER	CAIXA BOX	REFERÊNCIA REFERENCE
<b>DOBRADIÇA 45°</b>	14-21	45°	Ø35	100 UN	<b>D100002120</b>

**i** COM AMORTECEDOR  
SOFT CLOSE

## DOBRADIÇA 90°

90° HINGE

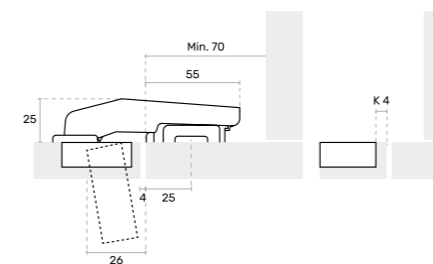

MODELO MODEL	ESPESSURA DA PLACA DOOR THICKNESS	ÂNGULO ANGLE	DIÂMETRO DIAMETER	CAIXA BOX	REFERÊNCIA REFERENCE
<b>DOBRADIÇA 90°</b>	14-21	90°	Ø35	100 UN	<b>D100002220</b>

**i** COM AMORTECEDOR  
SOFT CLOSE

## DOBRADIÇA 165°

165° HINGE

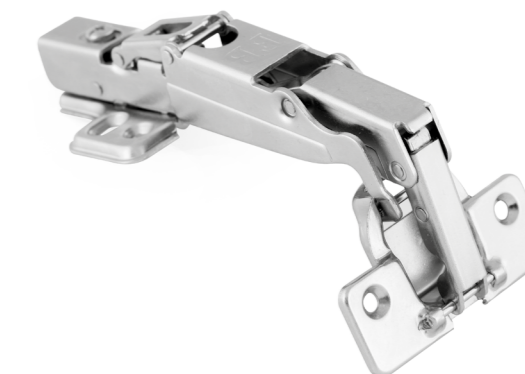
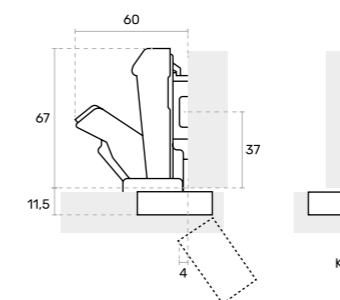

MODELO MODEL	ESPESSURA DA PLACA DOOR THICKNESS	ÂNGULO ANGLE	DIÂMETRO DIAMETER	CAIXA BOX	REFERÊNCIA REFERENCE
<b>DOBRADIÇA 165° 3D</b>	C=0				<b>D100011120</b>
<b>DOBRADIÇA 165°</b>	C=8	14-21	165°	Ø35	100 UN
	C=15				<b>D100002520</b>

**i** COM AMORTECEDOR  
SOFT CLOSE

## DOBRADIÇA MINI

MINI HINGE

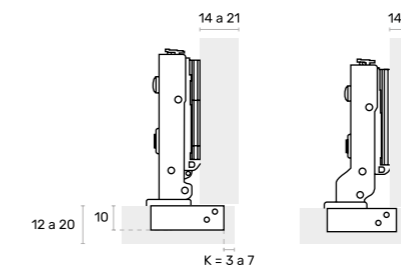

MODELO MODEL	ESPESSURA DA PLACA DOOR THICKNESS	ÂNGULO ANGLE	DIÂMETRO DIAMETER	CAIXA BOX	REFERÊNCIA REFERENCE
<b>DOBRADIÇA MINI</b>	C=0	14-21	95°	Ø26	100 UN
	C=8				<b>D100002720</b>

**i** COM AMORTECEDOR  
SOFT CLOSE

**DOBRADIÇA NH-D**  
NH-D HINGE

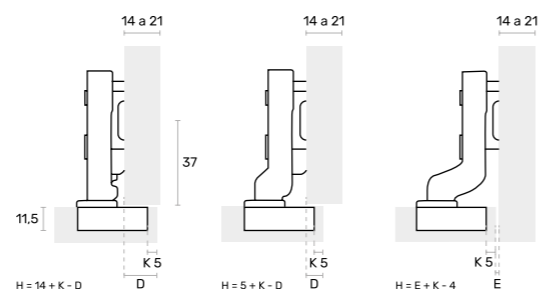

MODELO MODEL	ESPESSURA DA PLACA DOOR THICKNESS	ÂNGULO ANGLE	DIÂMETRO DIAMETER	CAIXA BOX	REFERÊNCIA REFERENCE
	C=0				<b>D100009220</b>
<b>DOBRADIÇA NH-D</b>	C=8	14-21	110°	200 UN	<b>D100009320</b>
	C=15				<b>D100009420</b>

**i** SIMPLES  
SLIDE ON

**DOBRADIÇA NH-C**  
NH-C HINGE

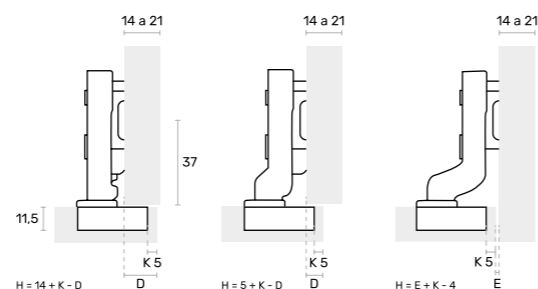

MODELO MODEL	ESPESSURA DA PLACA DOOR THICKNESS	ÂNGULO ANGLE	DIÂMETRO DIAMETER	CAIXA BOX	REFERÊNCIA REFERENCE
	C=0				<b>D100009520</b>
<b>DOBRADIÇA NH-C</b>	C=8	14-21	110°	200 UN	<b>D100009620</b>
	C=15				<b>D100009720</b>

**i** COM CLIP  
WITH CLIP

**DOBRADIÇA 102-135**  
102-135 HINGE

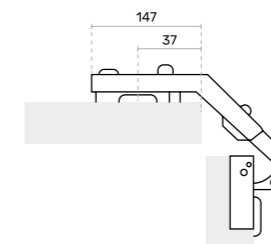

MODELO MODEL	ESPESSURA DA PLACA DOOR THICKNESS	ÂNGULO ANGLE	DIÂMETRO DIAMETER	CAIXA BOX	REFERÊNCIA REFERENCE
<b>DOBRADIÇA 102-135</b>	C=0	14-21	135°	100 UN	<b>D100004020</b>

**i** SIMPLES  
SLIDE ON

**DOBRADIÇA 102-165**  
102-165 HINGE

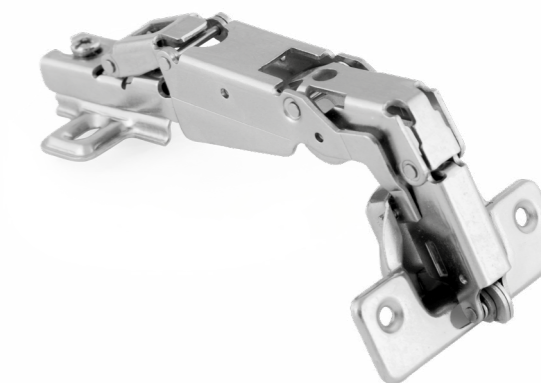
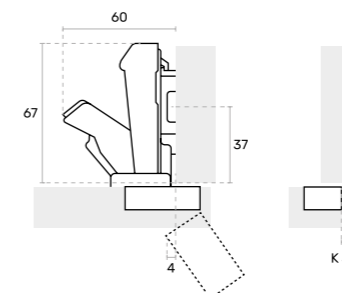

MODELO MODEL	ESPESSURA DA PLACA DOOR THICKNESS	ÂNGULO ANGLE	DIÂMETRO DIAMETER	CAIXA BOX	REFERÊNCIA REFERENCE
<b>DOBRADIÇA 102-165</b>	C=0	14-21	165°	100 UN	<b>D100004120</b>

**i** SIMPLES  
SLIDE ON

**DOBRADIÇA 102-BC2**  
102-BC2 HINGE

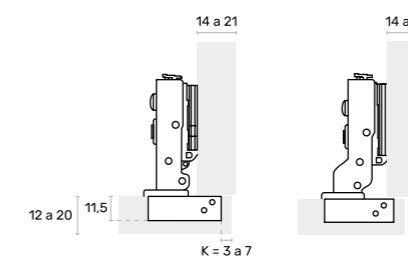

MODELO MODEL	ESPESSURA DA PLACA DOOR THICKNESS	ÂNGULO ANGLE	DIÂMETRO DIAMETER	CAIXA BOX	REFERÊNCIA REFERENCE
<b>DOBRADIÇA 102-BC2</b>	C=0	14-21	110°	200 UN	<b>D100004520</b>
	C=8				<b>D100004420</b>

**i** SIMPLES  
SLIDE ON

**DTC AMORTECEDOR 3D**  
SOFT CLOSING 3D DTC HINGE



MODELO MODEL	ESPESSURA DA PLACA DOOR THICKNESS	ÂNGULO ANGLE	DIÂMETRO DIAMETER	CAIXA BOX	REFERÊNCIA REFERENCE	
<b>DTC AMORTECEDOR 3D</b>	C=0				<b>D100007420</b>	
	C=8	14-21	110°	Ø35	200 UN	<b>D100007520</b>
	C=15					<b>D100007620</b>
<b>DTC AMORTECEDOR 3D 2W</b>	C=0	14-21	110°	Ø35	250 UN	<b>D1Q02Q2920</b>
<b>CALÇO</b>	H=0					<b>D100007720</b>
	H=2	14-21	-	Ø35	200 UN	<b>D100007820</b>

**DTC MOLA INVERTIDA**  
REVERSE SPRING DTC HINGE



**DTC SEM MOLA**  
DTC HINGE WITHOUT SPRING



MODELO MODEL	ESPESSURA DA PLACA DOOR THICKNESS	ÂNGULO ANGLE	DIÂMETRO DIAMETER	CAIXA BOX	REFERÊNCIA REFERENCE	
<b>DTC MOLA INVERTIDA</b>	C=0				<b>D100006220</b>	
	C=8	14-21	110°	Ø35	250 UN	<b>D100006320</b>
	C=15					<b>D100006420</b>
<b>DTC SEM MOLA</b>	C=0				<b>D100006520</b>	
	C=8	14-21	110°	Ø35	250 UN	<b>D100006620</b>
	C=15					<b>D100006720</b>

**DTC SIMPLES**  
SLIDE ON DTC HINGE



**DTC CLIP**  
CLIP ON DTC HINGE



MODELO MODEL	ESPESSURA DA PLACA DOOR THICKNESS	ÂNGULO ANGLE	DIÂMETRO DIAMETER	CAIXA BOX	REFERÊNCIA REFERENCE	
<b>DTC SIMPLES</b>	C=0				<b>D100005620</b>	
	C=8	14-21	110°	Ø35	200 UN	<b>D100005720</b>
	C=15					<b>D100005820</b>
<b>DTC CLIP</b>	C=0				<b>D100005920</b>	
	C=8	14-21	110°	Ø35	250 UN	<b>D100006020</b>
	C=15					<b>D100006120</b>
<b>DTC CLIP C/CALÇO 3D</b>	C=0				<b>D100007120</b>	
	C=8	14-21	110°	Ø35	250 UN	<b>D100007220</b>
	C=15					<b>D100007320</b>

**DTC BC**  
BC HINGE



**DTC 90°**  
90° DTC HINGE



MODELO MODEL	ESPESSURA DA PLACA DOOR THICKNESS	ÂNGULO ANGLE	DIÂMETRO DIAMETER	CAIXA BOX	REFERÊNCIA REFERENCE	
<b>DTC BC</b>	C=0				<b>D100008020</b>	
	C=8	14-21	110°	Ø35	500 UN	<b>D100008120</b>
<b>DTC 90°</b>	C=0	14-21	90°	Ø35	250 UN	<b>D100008620</b>



## DOBRADIÇAS DTC

DTC HINGES

**DTC 165°**  
165° HINGE

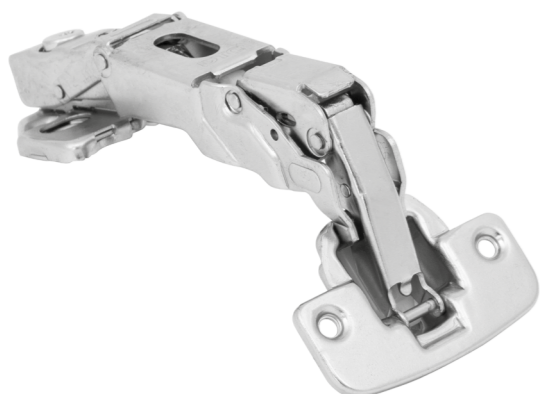

**DTC COPO 40MM**  
40MM CUP DTC HINGE



MODELO MODEL		ESPESSURA DA PLACA DOOR THICKNESS	ÂNGULO ANGLE	DIÂMETRO DIAMETER	CAIXA BOX	REFERÊNCIA REFERENCE
<b>DTC 165°</b>	C=0	14-21	165°	Ø35	100 UN	<b>D100010020</b>
	C=0					<b>D100006820</b>
<b>DTC COPO 40MM</b>	C=8	14-21	110°	Ø40	250 UN	<b>D100006920</b>
	C=15					<b>D100007020</b>
<i>i</i> SIMPLES SLIDE ON						
<b>DTC COPO 40MM AMORTECEDOR 3D 2W</b>	C=0					<b>D1Q0211020</b>
	C=8	14-21	95°	Ø40	250 UN	<b>D1Q0211120</b>
	C=15					<b>D1Q0211220</b>

**DOB.R.DTC3D**  
DOB.R.DTC3D



*i* COM CLIP  
WITH CLIP

MODELO MODEL		ESPESSURA DA PLACA DOOR THICKNESS	ÂNGULO ANGLE	DIÂMETRO DIAMETER	CAIXA BOX	REFERÊNCIA REFERENCE
<b>DTC 165°</b>	C=0	14-21	110°	Ø35	250 UN	<b>DOB.R.DTC3D</b>

**ITALIANA**  
ferramenta

## DOBRADIÇA KIMANA

KIMANA HINGE



MODELO MODEL	ACABAMENTO FINISHING	DIÂMETRO DIAMETER	CAIXA BOX	REFERÊNCIA REFERENCE
<b>KIMANA</b>	● GRAFITE GRAPHITE	-	150 UN	<b>40120010HX</b>
<b>PARAFUSOS</b>	● GRAFITE GRAPHITE	3,5x16	-	<b>60101390HX</b>

**G\*GRASS**

## DOBRADIÇA GRASS

GRASS HINGE

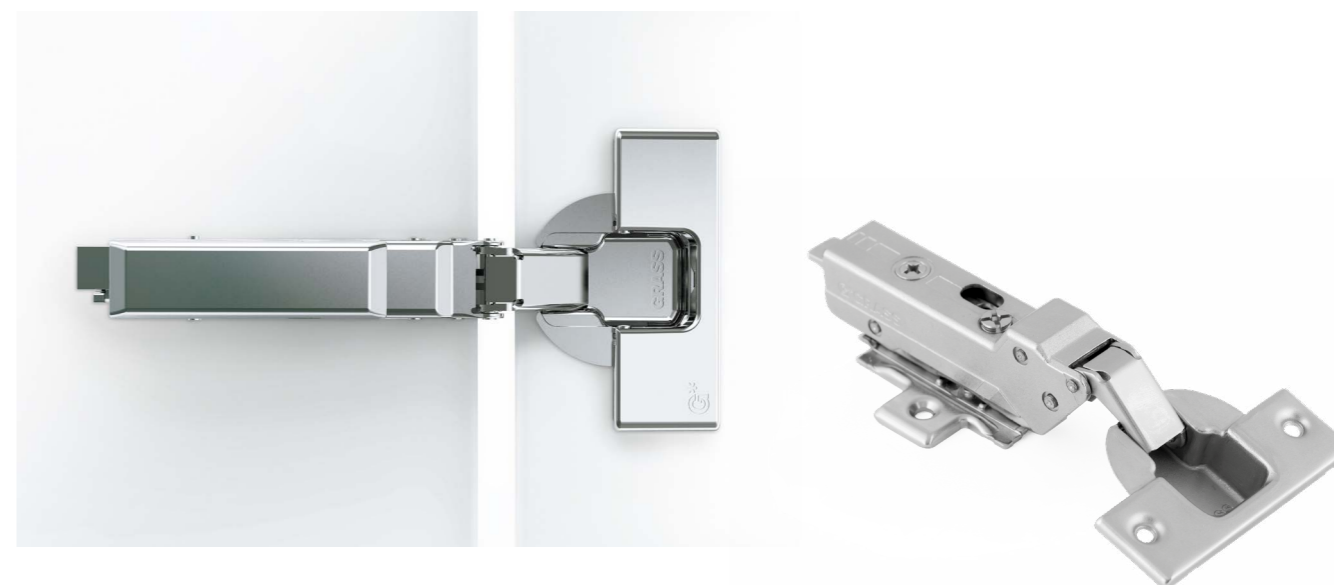

MODELO MODEL		ESPESSURA DA PLACA DOOR THICKNESS	ÂNGULO ANGLE	DIÂMETRO DIAMETER	CAIXA BOX	REFERÊNCIA REFERENCE
<b>TIOMOS</b>	C=0	14-21	110°	Ø35	150 UN	<b>D110000120</b>
	C=8					<b>D110000320</b>
<b>CALÇO TIOMOS</b>						<b>D120000120</b>