

DESIGN MOOVES US - 20 YEARS

**FERRAGENS
E COMPONENTES**
PARA O MOBILIÇARIO



A NOSSA EMPRESA + 20 ANOS

SOBRE NÓS

A FEBOL é uma empresa familiar, fundada em 2002, contou com a experiência e conhecimento do seu fundador que foi o espelho do seu crescimento. Especializamo-nos em ferragens e componentes essencialmente para cozinhas e roupeiros, num vasto conjunto de soluções, sendo destaque a variedade de produtos que disponibilizamos no mercado, bem como a qualidade dos mesmos. Os já 20 anos de experiência e know-how que temos neste ramo de atividade, simbolizam a dedicação da equipa em aconselhar e acompanhar os nossos clientes.

Com sede em Águeda, distrito de Aveiro e filial em Paços de Ferreira, a FEBOL procura trabalhar em conjunto com os seus clientes, de forma a desenvolver e procurar continuamente novos produtos a nível nacional e internacional com a qualidade cada vez mais exigente, a preços competitivos.

ABOUT US

FEBOL is a family owned company, founded in 2002, that has grown thanks to its founder's experience and knowledge. We specialize in hardware and fittings, especially for kitchens and wardrobes, and we have a large range of products with very good quality.

The over 20 years of experience and know-how we have in our market reflects the team's dedication in advising and keeping up with our customer's demands.

Our head office is in Águeda, district of Aveiro, but we also have a subsidiary company in Paços de Ferreira. Our company is continuously looking for a closer approach to customers, as a way of developing and searching for new products, nationally and internationally with the most demanding quality required, but keeping very competitive prices.



MISSÃO

Primar em cada venda pela satisfação do cliente, para que este se sinta seguro. É imperativo para a Febol dispor no seu stock de uma vasta variedade de produtos. Ao escolher criteriosamente os produtos que comercializa, temos em vista desenvolver com cada cliente ao longo do tempo uma relação de cooperação e confiança.

MISSION

Customer satisfaction is our main goal and in order to achieve this it is essential to have a large range of products. Our goal is to develop a long and continuous business relationship based on cooperation and trust.



VISÃO

O compromisso da Febol é crescer e ajudar os seus clientes a crescer consigo, assente numa relação de confiança e proximidade. Trabalhamos diariamente para sermos o parceiro de confiança.

VISION

Febol's commitment is to grow and help our customers grow as well, based on a close and trustworthy relationship. We work daily to be your ideal partner.



VALORES

A seriedade do seu atendimento bem como as preocupações pós venda são pilares sobre os quais a Febol construiu e constrói o compromisso com o cliente. A ética nas relações comerciais e a aposta na formação de uma equipa qualificada atenta às necessidades de mercado são o nosso foco. O compromisso com o cliente está no centro de tudo o que fazemos.

VALUES

The professional service we provide, as well as after sales assistance are a commitment to the customer. The comercial relationship ethics and the investment in continuous professional qualification development, attentive to the market's needs are our goals. The commitment to the customer is the center of everything we do.

ÍNDICE

INDEX

01 VITRINES GLASS DOORS	P.06-09	08 DOBRADIÇAS HINGES	P.136-147
02 COZINHAS KITCHENS	P.10-41	09 PERFIS DE ALUMÍNIO PARA COZINHAS E ROUPEIROS ALUMINIUM PROFILES FOR KITCHENS AND WARDROBES	P.148-181
03 ASAS E PUXADORES HANDLES AND KNOBS	P.42-57	10 ROUPEIROS WARDROBES	P.182-191
04 ACESSÓRIOS INTERIORES COZINHA E LAVANDARIA KITCHEN STORAGE AND LAUNDRY CARE	P.58-75	11 SISTEMAS DE FIXAÇÃO CONNECTION AND MOUNTING SYSTEMS	P.192-215
05 BALDES DO LIXO WASTE BINS	P.76-91	12 ESCRITÓRIO OFFICE	P.216-221
06 LAVA LOUÇAS KITCHEN SINKS	P.92-115	13 OUTRO PRODUTOS OTHER PRODUCTS	P.222-227
07 GAVETAS E CORREDIÇAS DRAWERS AND SLIDES	P.116-135		



01

VITRINES
GLASS DOORS

INCOLOR (TRANSPARENTE)
CLEAR GLASS

FOSCO
FROSTED GLASS

GRIS
GRAY GLASS

BRONZE
BRONZE GLASS

LACADO BRANCO
WHITE GLASS

LACADO PRETO
BLACK GLASS

EXTRA CLARO BRANCO
EXTRA WHITE GLASS

ESPELHOS (INCOLOR/GRIS/BRONZE)
MIRROR

VITRINE A

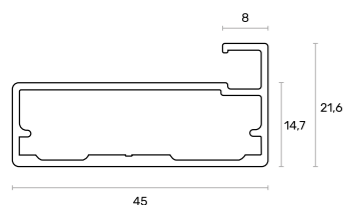

ACABAMENTOS FINISHING

- BRANCO MATE
MATT WHITE
- ANODIZADO
ANODIZED
- INOX MATE
MATT CHAMPAGNE ANODIZED
- OURO MATE
MATT GOLD COLOURED
- PRETO MATE
MATT BLACK

VITRINE A1

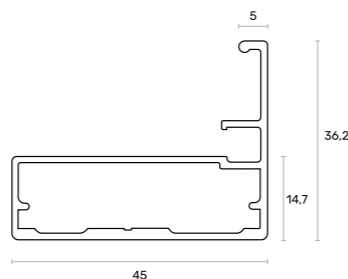

ACABAMENTOS FINISHING

- BRANCO MATE
MATT WHITE
- ANODIZADO
ANODIZED
- PRETO MATE
MATT BLACK

VITRINE B

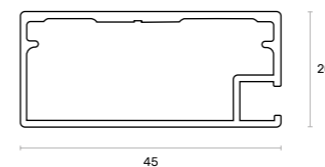

ACABAMENTOS FINISHING

- BRANCO MATE
MATT WHITE
- ANODIZADO
ANODIZED
- OURO BRILHO
BRIGHT GOLD COLOURED
- PRETO MATE
MATT BLACK
- OURO MATE
MATT GOLD COLOURED

VITRINE D

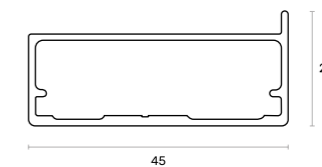

ACABAMENTOS FINISHING

- BRANCO MATE
MATT WHITE
- ANODIZADO
ANODIZED
- PRETO MATE
MATT BLACK

VITRINE F

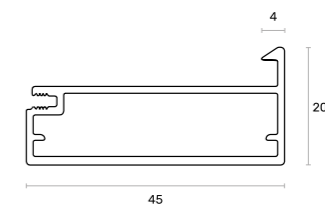

ACABAMENTOS FINISHING

- BRANCO MATE
MATT WHITE
- ANODIZADO
ANODIZED
- PRETO MATE
MATT BLACK

02

COZINHAS KITCHEN

12 PÉS PARA RODAPÉS
E GRAMPAS
ADJUSTABLE BOTTOM LEGS AND CLIPS

15 RODAPÉ PVC
ARTIFICIAL RESIN PLINTHS

19 RODAPÉ ALUMÍNIO
ALUMINIUM PLINTHS

22 FUNDOS, GRELHAS E BASES
BOTTOMS, GRIDS AND BASES

25 PÉS PARA DECORAÇÃO
DECORATIVE LEGS

27 TAPETES ANTIDESLIZANTES
ANTISLIP MAT

28 PORTA TALHERES
CUTLERY TRAY

32 PERSIANAS
ROLLER SHUTTER

34 SISTEMAS DE ELEVAÇÃO
LIFTING SYSTEMS

PÉS PARA RODAPÉ E GRAMPAS

ADJUSTABLE BOTTOM LEGS AND CLIPS

HOGAR

HOGAR



PARA ALUMÍNIO
FOR ALUMINIUM



PARA MADEIRA
FOR WOOD



AFINAÇÃO PARA MADEIRA
ADJUSTMENT FOR WOOD

MODELO MODEL	ALTURA (MM) HEIGHT (MM)	CAIXA BOX	REFERÊNCIA REFERENCE
HOGAR	80 (80-100)	240 UN	K510011921
	100 (100-150)	200 UN	K510012021
	120 (120-170)	200 UN	K510012121
	150 (140-190)	200 UN	K510012221
GRAMPAS	PARA ALUMÍNIO	-	K510004621
	PARA MADEIRA	400 UN	K510004721
	AFINAÇÃO PARA MADEIRA	-	K510004821

BONE

BONE



60 E 80
60 AND 80



100, 120 E 150
100,120 AND 150



PARA ALUMÍNIO 721
FOR ALUMINIUM 721

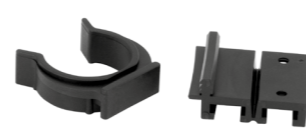

PARA ALUMÍNIO E MADEIRA 121
FOR ALUMINIUM AND WOOD 121

MODELO MODEL	ALTURA (MM) HEIGHT (MM)	CAIXA BOX	REFERÊNCIA REFERENCE
BONE	60 (56/66)		K510006221
	80 (74/84)		K510006321
	100 (100/120)	200 UN	K510006421
	120 (120/150)		K510006521
	150 (150/180)		K510006621
GRAMPAS	PARA ALUMÍNIO 721		K510006721
	PARA ALUMÍNIO / MADEIRA 121	200 UN	K510008121

PÉS PARA RODAPÉ E GRAMPAS

ADJUSTABLE BOTTOM LEGS AND CLIPS

REDONDO

REDONDO



MILÃO

MILÃO



VIGO

VIGO

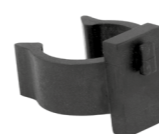

PARA ALUMÍNIO - 285 - 1.5
FOR ALUMINIUM - 285 - 1.5

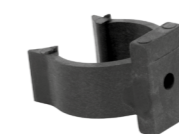

PARA ALUMÍNIO - 287 - 2.0
FOR ALUMINIUM - 287 - 2.0



PARA MADEIRA - 282
FOR WOOD - 282



PARA ALUMÍNIO - 970
FOR ALUMINIUM - 970



PARA MADEIRA - 971
FOR WOOD - 971

MODELO MODEL	ALTURA (MM) HEIGHT (MM)	CAIXA BOX	REFERÊNCIA REFERENCE	
REDONDO	100 (100-140)	200 UN	K510004921	
	120 (120-160)	180 UN	K510005021	
	150 (140-180)	150 UN	K510005121	
COM BUCHA	120 (120-160)	180 UN	K510008621	
MILÃO	80 (75-90)		K510005521	
	100 (100-130)		K510005621	
	150 (130-145)	200 UN	K510005721	
	COM BUCHA	100 (100-130)		K510008321
	150 (130-145)		K510008421	
VIGO	80 (80-100)	200 UN	K510015921	
	100 (100-130)	200 UN	K510016021	
	120 (120-170)	200 UN	K510016121	
GRAMPAS	150 (130-145)	200 UN	K510016221	
	PARA ALUMÍNIO - 285	-	K510005221	
	PARA ALUMÍNIO - 287	-	K510005321	
	PARA MADEIRA - 282	-	K510005421	
	PARA ALUMÍNIO - 970	-	K510005821	
PARA MADEIRA - 971	-	K510005921		

PÉS PARA RODAPÉ E GRAMPAS

ADJUSTABLE BOTTOM LEGS AND CLIPS

scilm
FURNITURE TECHNOLOGY

SCILM R28C

R28C SCILM



MODELO MODEL	ALTURA (MM) HEIGHT (MM)	CAIXA BOX	REFERÊNCIA REFERENCE
SCILM R28C	60 (60/70)	1000 UN	K510009021
	80 (80/90)		K510009121
GRAMPA 54	-	1500 UN	K510009921
CHAVE PARA R28C	-	01 UN	K510010020

SCILM R50

R50 SCILM



scilm
FURNITURE TECHNOLOGY

MODELO MODEL	ALTURA (MM) HEIGHT (MM)	CAIXA BOX	REFERÊNCIA REFERENCE
SCILM R50	80 (80/95)	450 UN	K510007221
	100 (100/115)	350 UN	K510006821
	120 (120/135)	300 UN	K510006921
	150 (150/165)	240 UN	K510007021
	170 (170/185)	200 UN	K510007121
GRAMPA 54	-	1500 UN	K510009921

scilm
FURNITURE TECHNOLOGY

RODAPÉ SCILM

SCILM PLINTH

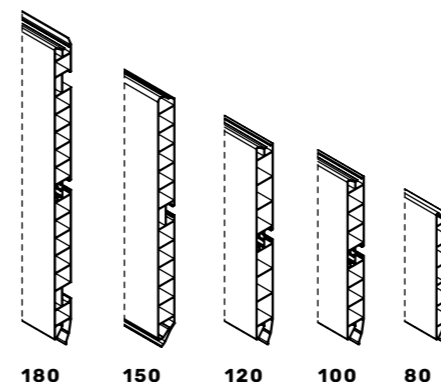

RODAPÉS PVC

ARTIFICIAL RESIN PLINTHS

MODELO MODEL	ACABAMENTO FINISHING	ALTURA (MM) HEIGHT (MM)	COMPRIMENTO (MM) LENGTH (MM)	CAIXA (M) BOX (M)	REFERÊNCIA REFERENCE
RODAPÉ SCILM	BRANCO MATE MATT WHITE	80	4000	72	K512000003
		100		44	K512009003
		120		40	K512009103
		150		36	K512009203
		180		32	K512009303
	BRANCO BRILHO BRIGHT WHITE	100	4000	44	K512009002
		120		40	K512009102
		150		36	K512009202
		180		32	K512009302
		80		72	K512000017
	ALUMÍNIO ALUMINIUM	100	4000	44	K512009017
		120		40	K512009117
		150		36	K512009217
		180		32	K512009317
		100		44	K512009037
OURO GOLD	120	4000	40	K512009137	
	150		36	K512009237	
	100		44	K512009040	
	120		40	K512009140	
	150		36	K512009240	
ROSA DOURADO GOLDEN ROSE	100	4000	44	K512009010	
	120		40	K512009110	
	150		36	K512009210	
	180		32	K512009310	
	80		72	K512000024	
INOX STAINLESS STEEL	100	4000	44	K512009024	
	120		40	K512009124	
	150		36	K512009224	
	180		32	K512009324	
	80		72	K512000009	
ANTRACITE ANTHRACITE	100	4000	44	K512009009	
	120		40	K512009109	
	150		36	K512009209	
	180		32	K512009309	
	80		72	K512000009	
PRETO BLACK	100	4000	44	K512009009	
	120		40	K512009109	
	150		36	K512009209	
	180		32	K512009309	
	80		72	K512000009	

CANTO 90° SCILM
SCILM 90° CORNER

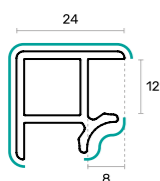
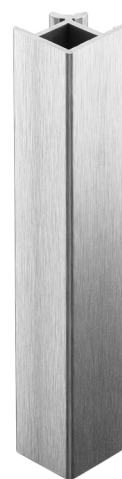

MODELO MODEL	ACABAMENTO FINISHING	ALTURA (MM) HEIGHT (MM)	CAIXA (M) BOX (M)	REFERÊNCIA REFERENCE	
CANTO 90° SCILM	○ BRANCO MATE MATT WHITE	100	-	K510000503	
		120	-	K510000603	
		150	-	K510000703	
		180	-	K510000803	
	○ BRANCO BRILHO BRIGHT WHITE	150	-	K510000702	
		100	-	K510000517	
		120	-	K510000617	
	● ALUMÍNIO ALUMINIUM	150	-	K510000717	
		180	-	K510000817	
		150	-	K510000737	
	● OURO GOLD	● ROSA DOURADO GOLDEN ROSE	150	-	K510000740
			150	-	K510000740
	● INOX STAINLESS STEEL	100	-	K510000510	
		120	-	K510000610	
		150	-	K510000710	
		180	-	K510000810	
		100	-	K510000524	
		120	-	K510000624	
● ANTRACITE ANTHRACITE	150	-	K510000724		
	180	-	K510000824		
	100	-	K510000509		
● PRETO BLACK	120	-	K510000609		
	150	-	K510000709		
	180	-	K510000809		

CANTO FLEXÍVEL SCILM
SCILM 180° MULTICORNER

MODELO MODEL	ACABAMENTO FINISHING	ALTURA (MM) HEIGHT (MM)	CAIXA (M) BOX (M)	REFERÊNCIA REFERENCE	
CANTO FLEXÍVEL SCILM	○ BRANCO MATE MATT WHITE	100	-	K510010003	
		120	-	K510000903	
		150	-	K510001003	
		180	-	K510001103	
	○ BRANCO BRILHO BRIGHT WHITE	150	-	K510001002	
		100	-	K510010017	
		120	-	K510000917	
	● ALUMÍNIO ALUMINIUM	150	-	K510001017	
		180	-	K510001117	
		150	-	K510001037	
	● OURO GOLD	● ROSA DOURADO GOLDEN ROSE	150	-	K510001040
			150	-	K510001040
	● INOX STAINLESS STEEL	120	-	K510000910	
		150	-	K510001010	
		180	-	K510001110	
	● ANTRACITE ANTHRACITE	100	-	K510010024	
		120	-	K510000924	
		150	-	K510001024	
● PRETO BLACK	180	-	K510001124		
	100	-	K510010009		
	120	-	K510000909		
● PRETO BLACK	150	-	K510001009		
	180	-	K510001109		

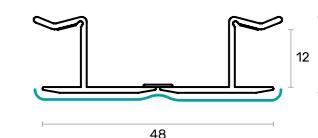

UNIÃO SCILM
SCILM LINEAR JOINT

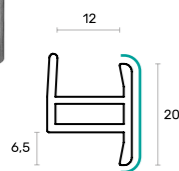

MODELO MODEL	ACABAMENTO FINISHING	ALTURA (MM) HEIGHT (MM)	CAIXA BOX	REFERÊNCIA REFERENCE
UNIÃO SCILM	○ BRANCO WHITE	150	-	K510001203
		180	-	K510001303
	● ALUMÍNIO ALUMINIUM	150	-	K510001217
		150	-	K510001210
	● ANTRACITE ANTHRACITE	150	-	K510001224
		150	-	K510001209

TERMINAL SCILM
SCILM END CAP

MODELO MODEL	ACABAMENTO FINISHING	ALTURA (MM) HEIGHT (MM)	CAIXA BOX	REFERÊNCIA REFERENCE
TERMINAL	○ BRANCO WHITE	150	-	K510010603
		150	-	K510010617
	● ANTRACITE ANTHRACITE	150	-	K510010624
		150	-	K510010609

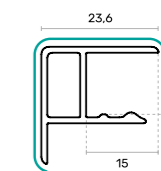

RODAPÉS PVC

ARTIFICIAL RESIN PLINTHS



RODAPÉ R20

R20 PLINTH

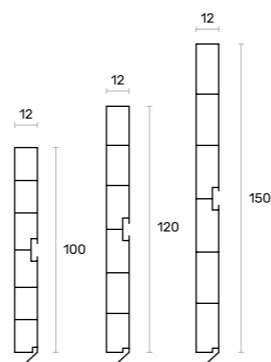

MODELO MODEL	ACABAMENTO FINISHING	ALTURA (MM) HEIGHT (MM)	COMPRIMENTO (MM) LENGTH (MM)	CAIXA (M) BOX (M)	REFERÊNCIA REFERENCE
RODAPÉ R20	● ALUMÍNIO ALUMINIUM	100	4000	40	K510201417
		120		40	K510201517
		150		40	K510201617

ACESSÓRIOS PARA RODAPÉ PVC

REVESTIDO ALUMÍNIO

ACCESSORIES ALUMINIUM PVC PLINTH



MODELO MODEL	ALTURA (MM) HEIGHT (MM)	CAIXA BOX	REFERÊNCIA REFERENCE
CANTO FLEXÍVEL	100	-	K510002117
	120	-	K510002217
	150	-	K510002317
	180	-	K51008217
CANTO 90°	100	-	K510001717
	120	-	K510001817
	150	-	K510001917
UNIÃO	100	-	K510002417
	120	-	K510002517
	150	-	K510002617

RODAPÉS ALUMÍNIO

ALUMINIUM PLINTHS

RODAPÉ ALUMÍNIO R27

R27 ALUMINIUM PLINTH

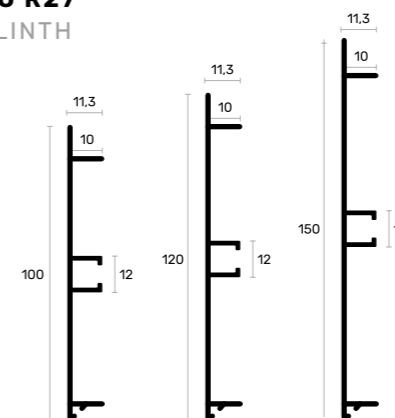

MODELO MODEL	ACABAMENTO FINISHING	ALTURA (MM) HEIGHT (MM)	COMPRIMENTO (MM) LENGTH (MM)	CAIXA (M) BOX (M)	REFERÊNCIA REFERENCE
RODAPÉ ALUMÍNIO R27	○ BRANCO MATE MATT WHITE	100	5000	40	K515004103
		120			K515004203
		150			K515004303
	● ALUMÍNIO ALUMINIUM	100	5000	40	K515004101
		120			K515004201
		150			K515004301
	● OURO MATE MATT GOLD COLOURED	100	5000	40	K515004134
		120			K515004234
		150			K515004334
	● PRETO MATE MATT BLACK	100	5000	40	K515004109
		120			K515004209
		150			K515004309



ACESSÓRIOS PARA RODAPÉ ALUMÍNIO R27
ACCESSORIES ALUMINIUM R27 PLINTH

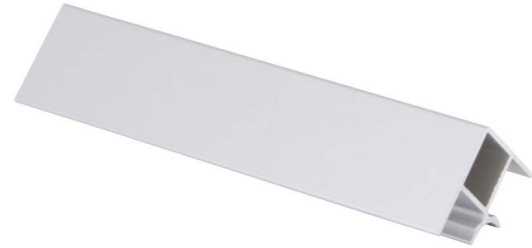

CANTO FLEXÍVEL 761
761 MULTICORNER

CANTO 90° 761
90° 761 CORNER

MODELO MODEL	ACABAMENTO FINISHING	ALTURA (MM) HEIGHT (MM)	CAIXA (M) BOX (M)	REFERÊNCIA REFERENCE
CANTO FLEXÍVEL 761	BRANCO MATE MATTE WHITE	80	-	FK51000006
		100	-	FK51000007
		120	-	FK51000008
		150	-	FK51000009
		180	-	FK51000010
	ALUMÍNIO ALUMINIUM	80	-	FK51000001
		100	-	FK51000002
		120	-	FK51000003
		150	-	FK51000004
		180	-	FK51000005
	PRETO MATE MATTE BLACK	80	-	FK51000011
		100	-	FK51000012
		120	-	FK51000013
		150	-	FK51000014
		180	-	FK51000015
CANTO 90° 761	BRANCO MATE MATTE WHITE	100	-	FK51761203
		120	-	FK51761303
		150	-	FK51761403
		180	-	FK51761503
		100	-	FK51761201
	ALUMÍNIO ALUMINIUM	120	-	FK51761301
		150	-	FK51761401
		180	-	FK51761501
		100	-	FK51761209
		120	-	FK51761309
	PRETO MATE MATTE BLACK	150	-	FK51761409
		180	-	FK51761509



CANTO FLEXÍVEL 03
03 MULTICORNER

CANTO 90° 03
90° 03 CORNER



GRAMPA N°1
N°1 CLIP

GRAMPA N°2
N°2 CLIP

MODELO MODEL	ACABAMENTO FINISHING	ALTURA (MM) HEIGHT (MM)	CAIXA (M) BOX (M)	REFERÊNCIA REFERENCE
CANTO FLEXÍVEL 03	BRANCO MATE MATTE WHITE	100	-	K510003503
		150	-	K510003703
	ALUMÍNIO ALUMINIUM	100	-	K510003501
		120	-	K510003601
		150	-	K510003701
CANTO 90° 03	BRANCO MATE MATTE WHITE	100	-	K510003103
		150	-	K510003303
	ALUMÍNIO ALUMINIUM	100	-	K510003101
		120	-	K510003201
		150	-	K510003301
	PRETO MATE MATTE BLACK	100	-	K510003109
		120	-	K510003209
		150	-	K510003309
		GRAMPA N°1	-	-
GRAMPA N°2	-	-	2800	K510004021

i POSSIBILIDADE DE FAZER POR MEDIDA
POSSIBILITY OF MAKING TO MEASURE

FUNDOS, BASES E GRELHAS

BOTTOMS, BASES AND GRIDS

FUNDOS, BASES E GRELHAS

BOTTOMS, BASES AND GRIDS

FUNDO PROTECTOR

SINK BOTTOM PROTECTION



i CONSULTAR PARA DIFERENTES PROFUNDIDADES
CHECK AVAILABILITY FOR DIFFERENT DEPTHS

FUNDO PROTECTOR PLÁSTICO SERIE 900

SINK BOTTOM PROTECTION SERIES 900



MODELO MODEL	MÓDULO CABINET	B - LARGURA B - WIDTH	PROFUNDIDADE DEPTH	ALTURA HEIGHT	CAIXA BOX	REFERÊNCIA REFERENCE			
	MOD. 500	470	560	PARA PLACA 16 MM	10 UN	K520002907			
	MOD. 600	570				K520003007			
	MOD. 700	670				K520003107			
	MOD. 800	770				K520003207			
	MOD. 900	870				K520003307			
	MOD. 1000	970				K520003407			
	MOD. 1100	1070				K520003507			
	MOD. 1200	1170				K520003607			
FUNDO PROTECTOR ALUMÍNIO	MOD. 500	470				560	PARA PLACA 19 MM	10 UN	K520003707
	MOD. 600	570							K520003807
	MOD. 700	670	K520003907						
	MOD. 800	770	K520004007						
	MOD. 900	870	K520004107						
	MOD. 1000	970	K520004207						
	MOD. 1100	1070	K520004307						
	MOD. 1200	1170	K520004407						
FUNDO PROTECTOR PLÁSTICO SERIE 900 CINZA	MOD. 500	467	560	PARA PLACA 16/19 MM	50 UN				K529000122
	MOD. 600	567							K529000222
	MOD. 700	667				K529000322			
	MOD. 800	767				K529000422			
	MOD. 900	867				K529000522			
	MOD. 1000	967				K529000622			
	MOD. 1200	1167				K529000722			
FUNDO PROTECTOR PLÁSTICO SERIE 900 ANTRACITE	MOD. 500	467				560	PARA PLACA 16/19 MM	50 UN	K529000124
	MOD. 600	567							K529000224
	MOD. 700	667							K529000324
	MOD. 800	767	K529000424						
	MOD. 900	867	K529000524						
	MOD. 1000	967	K529000624						
	MOD. 1200	1167	K529000724						
PORTA DETERGENTES CINZA	150	445	-	-	30 UN				K529200122
PORTA DETERGENTES ANTRACITE									K529200124

GRELHA PARA FORNOS

OVEN VENTILATION GRILL

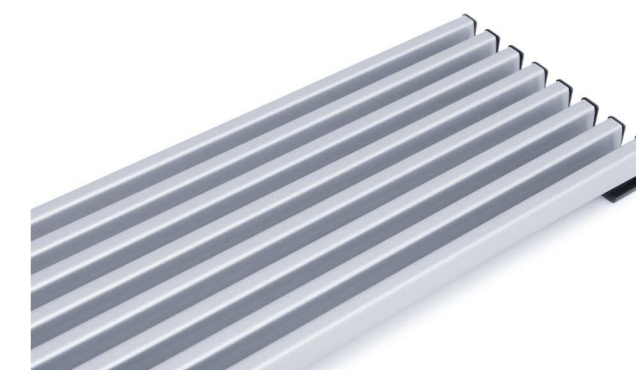

MODELO MODEL	MÓDULO CABINET	ACABAMENTO FINISH	MEDIDAS MEASURES	ELEMENTOS ELEMENTS	CAIXA BOX	REFERÊNCIA REFERENCE
GRELHA PARA FORNOS	MOD. 600	BRANCO BRILHO BRIGHT WHITE	598x124	8 ELEMENTOS	25 UN	K520004502
		CROMADO MATE MATTE CHROME	598x124	8 ELEMENTOS		K520004518
		INOX ESCOVADO BRUSHED STAINLESS STEEL	598x124	8 ELEMENTOS		K520004525
		INOX STAINLESS STEEL	598x124	8 ELEMENTOS		K520004512
	MOD. 600	PRETO BRILHO BRIGHT BLACK	598x124	8 ELEMENTOS		K520004508
	MOD. 600	INOX ESCOVADO BRUSHED STAINLESS STEEL	598x92	6 ELEMENTOS	25 UN	K520004725
	MOD. 900	CROMADO MATE MATTE CHROME	898x124	8 ELEMENTOS	25 UN	K520004618
		INOX ESCOVADO BRUSHED STAINLESS STEEL	898x124	8 ELEMENTOS		K520004625

GRELHA VENTILAÇÃO

PLINTH VENTILATION GRILL

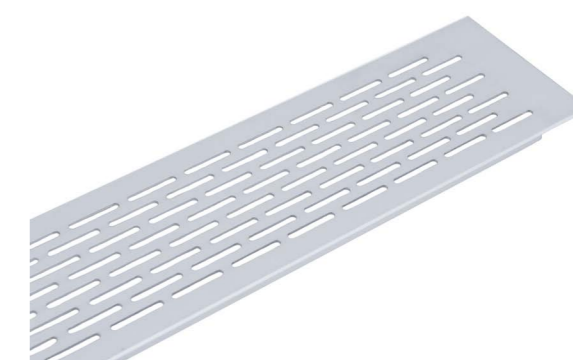
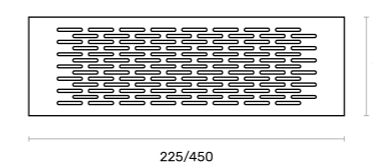

MODELO MODEL	ACABAMENTO FINISH	COMPRIMENTO LENGTH	ALTURA HEIGHT	CAIXA BOX	REFERÊNCIA REFERENCE
GRELHA DE VENTILAÇÃO	BRANCO MATE MATTE WHITE	225	70	100 UN / 10 UN	K520004803
		450			K520004903
	ALUMÍNIO ALUMINIUM	225	70	100 UN / 10 UN	K520004801
		450			K520004901
	PRETO MATE MATTE BLACK	225	70	100 UN / 10 UN	K520004809
		450			K520004909

i TAMANHO PERSONALIZÁVEL
ALL SIZES

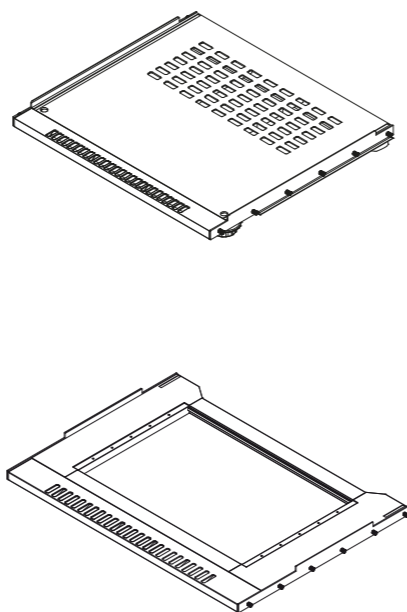

BASE 877
877 BASE

BASE 881
881 BASE



MODELO MODEL	MEDIDAS MEASURES	ALTURA HEIGHT	CAIXA BOX	REFERÊNCIA REFERENCE
BASE 877	-	PARA PLACA 16	01 UN	K521687721
	-	PARA PLACA 19	01 UN	K521987721
BASE 881	-	PARA PLACA 19	01 UN	K521988121

i COMPATÍVEL COM PÉS DA SCILM
COMPATIBLE WITH SCILM FEET

PÉ CÓNICO
CONICAL ADJUSTABLE LEG

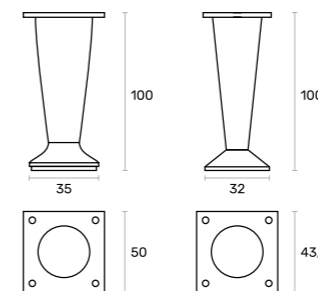

PÉ CÓNICO N°1
N°1 CONIC LEG

PÉ CÓNICO N°2
N°2 CONIC LEG

MODELO MODEL	ACABAMENTO FINISH	ALTURA (MM) HEIGHT (MM)	CAIXA BOX	REFERÊNCIA REFERENCE
PÉ CÓNICO N°1	● NIQUELADO ESCOVADO BRUSHED NICKEL	100	100 UN	K520000114
PÉ CÓNICO N°2		100	200 UN	K520015014

PÉ QUADRADO ALUMÍNIO FB
FB SQUARE LEG

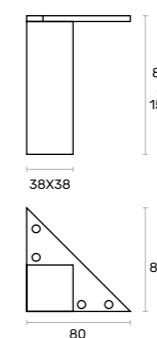

SUPOORTE DIAGONAL DE BALCÃO
INCLINED BALCONY LEG

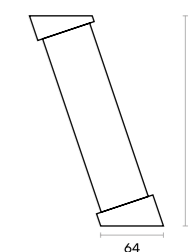

MODELO MODEL	ACABAMENTO FINISH	MEDIDAS MEASURES	ALTURA (MM) HEIGHT (MM)	CAIXA BOX	REFERÊNCIA REFERENCE
PÉ QUADRADO ALUMÍNIO	● ALUMÍNIO ALUMINIUM	38X38X80	80	200 UN	K520000201
		38X38X100	100		K520000301
		38X38X120	120		K520000401
		38X38X150	150		K520000501
SUPOORTE DIAGONAL DE BALCÃO	● NIQUELADO ESCOVADO BRUSHED NICKEL	64X210	-	20 UN	K520000714

PÉS PARA DECORAÇÃO

DECORATIVE LEGS



PÉ PARA BALCÃO

TABLE LEG



FIXAÇÃO 1
FIXING 1



FIXAÇÃO 2
FIXING 2



MODELO MODEL	ACABAMENTO FINISH	MEDIDA A + B A + B MEASURES	FIXAÇÃO FIXING	CAIXA BOX	REFERÊNCIA REFERENCE
PÉ PARA BALCÃO	● NIQUELADO SATINADO SATIN NICKEL	60X710	1	04 UN	K520001014
		60X820	1		K520001114
		60X900	2		K520001214
		60X1100	1		K520001314
	○ BRANCO BRILHO BRIGHT WHITE	80X710	2	04 UN	K520001402
		80X830	2		K520001502
		80X900	2		K520019002
	● NIQUELADO SATINADO SATIN NICKEL	80X830	2	04 UN	K520001514
		80X900	2		K520019014
	● PRETO MATE MATTE BLACK	80X710	2	04 UN	K520001409
		80X830	2		K520001509
		80X900	2		K520019009

PERNAS METÁLICAS PARA BANCO

METALLIC SEAT LEG

PERNAS METÁLICAS PARA MESA

METALLIC TABLE LEG

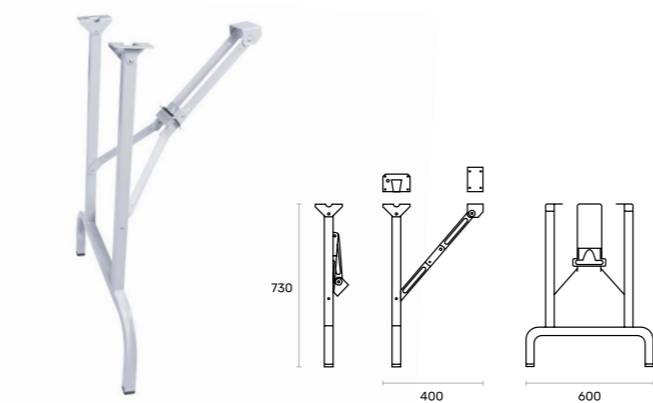
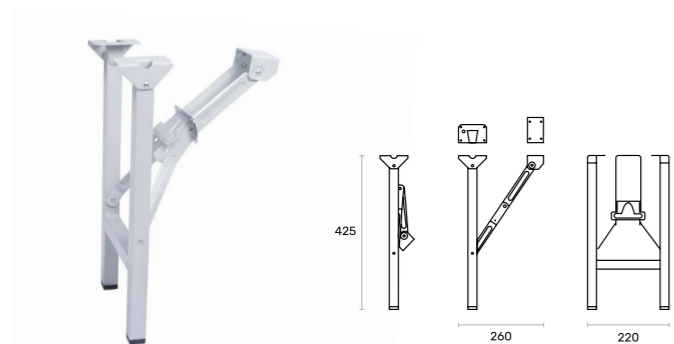

MODELO MODEL	ACABAMENTO FINISH	MEDIDAS MEASURES	CAIXA BOX	REFERÊNCIA REFERENCE
PERNAS METÁLICAS PARA BANCO	● CINZA GREY	220X260X425	01 UN	K520000822
	● BORDEAUX BORDEAUX	220X260X425	01 UN	K520000823
PERNAS METÁLICAS PARA MESA	● CINZA GREY	600X400X730	01 UN	K520000922
	● BORDEAUX BORDEAUX	600X400X730	01 UN	K520000923

TAPETES ANTIDESLIZANTES

ANTISLIP MAT



MODELO MODEL	ACABAMENTO FINISH	MEDIDAS MEASURES	CAIXA (M) BOX (M)	REFERÊNCIA REFERENCE
ROLO ANTIDEZLIZANTE	○ BRANCO WHITE	ROLO 20M 2000x480x1.2	01 UN	K520005626
	● CINZA GREY			K520005622
	● ANTRACITE ANTHRACITE			K520005624

CANVAS

CANVAS ANTISLIP MAT



MODELO MODEL	ACABAMENTO FINISH	MÓDULO CABINET	MEDIDAS MEASURES	CAIXA BOX	REFERÊNCIA REFERENCE
CANVAS	● CINZA GREY	MOD. 600	526X473X1.5	01 UN	K520012522
		MOD. 900	826X473X1.5		K520012622
		MOD. 1200	1126X473X1.5		K520012722
	● ANTRACITE ANTHRACITE	MOD. 600	526X473X1.5		K520012524
		MOD. 900	826X473X1.5		K520012624
		MOD. 1200	1126X473X1.5		K520012724

PORTA TALHERES
CUTLERY TRAY

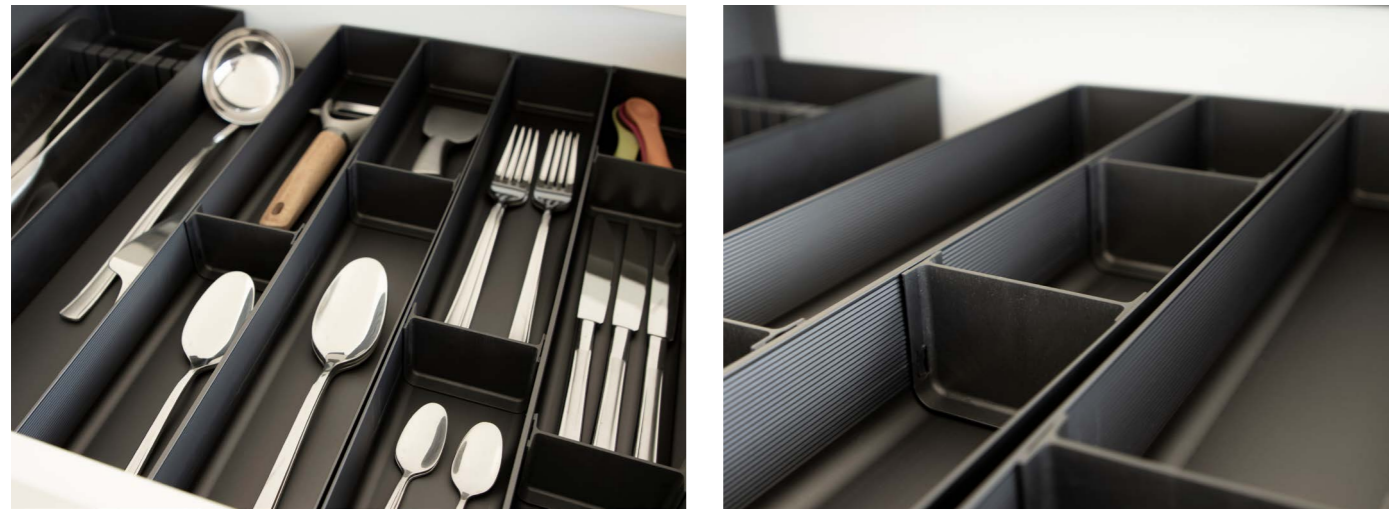

PORTA TALHERES
CUTLERY TRAY



GENERAL CATALOGUE

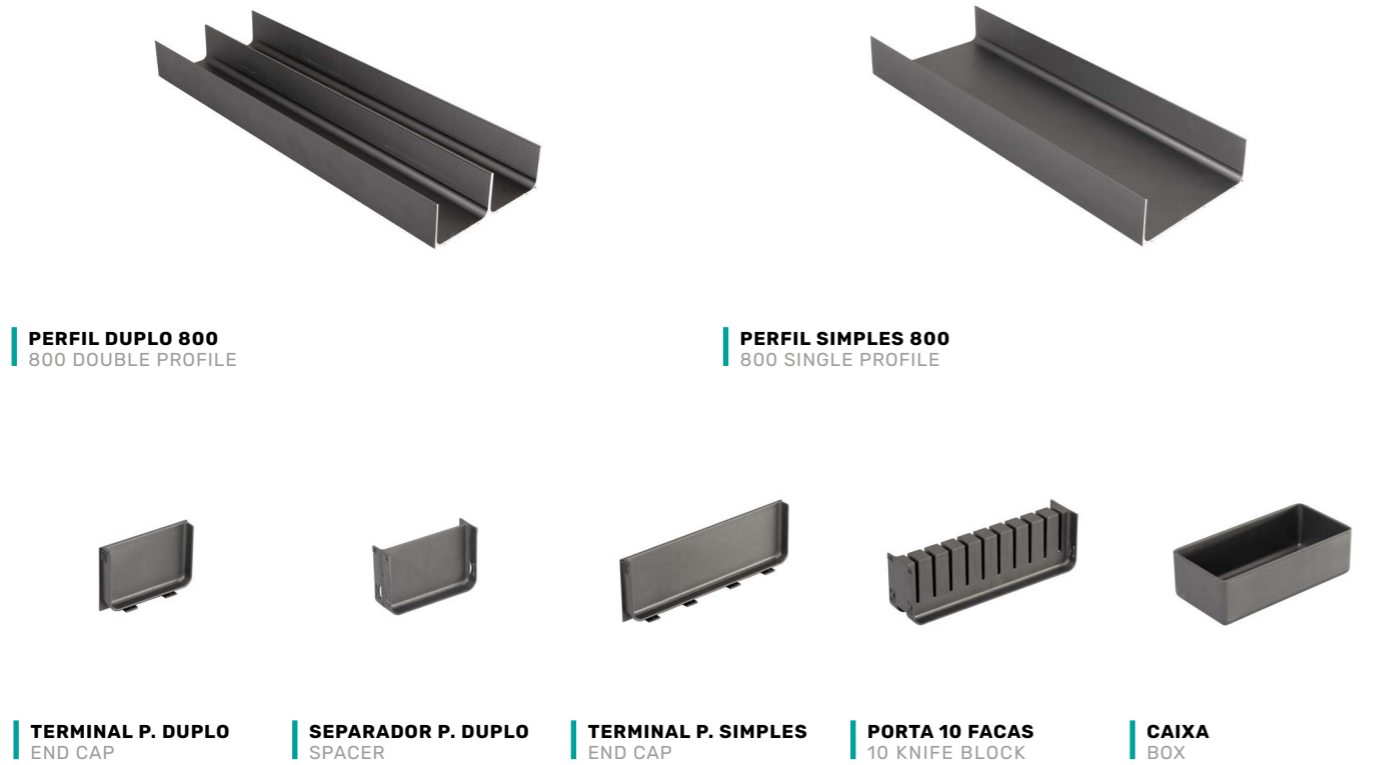

PERFIL DUPLO 800
800 DOUBLE PROFILE

PERFIL SIMPLES 800
800 SINGLE PROFILE

TERMINAL P. DUPLO
END CAP

SEPARADOR P. DUPLO
SPACER

TERMINAL P. SIMPLES
END CAP

PORTA 10 FACAS
10 KNIFE BLOCK

CAIXA
BOX

MODELO MODEL	ACABAMENTO FINISH	CAIXA BOX	REFERÊNCIA REFERENCE
PERFIL DUPLO 150X51X2100			K520821024
TERMINAL PARA PERFIL DUPLO	● ANTRACITE ANTHRACITE	01 UN	K520021124
SEPARADOR PARA PERFIL DUPLO			K520021224
PERFIL SIMPLES 150X51X2100			K520021324
TERMINAL PARA PERFIL SIMPLES	● ANTRACITE ANTHRACITE	01 UN	K520821424
PORTA 10 FACAS PARA PERFIL SIMPLES	● ANTRACITE ANTHRACITE	01 UN	K520021524
CAIXA	● ANTRACITE ANTHRACITE	01 UN	K520021624

PORTA TALHERES 800

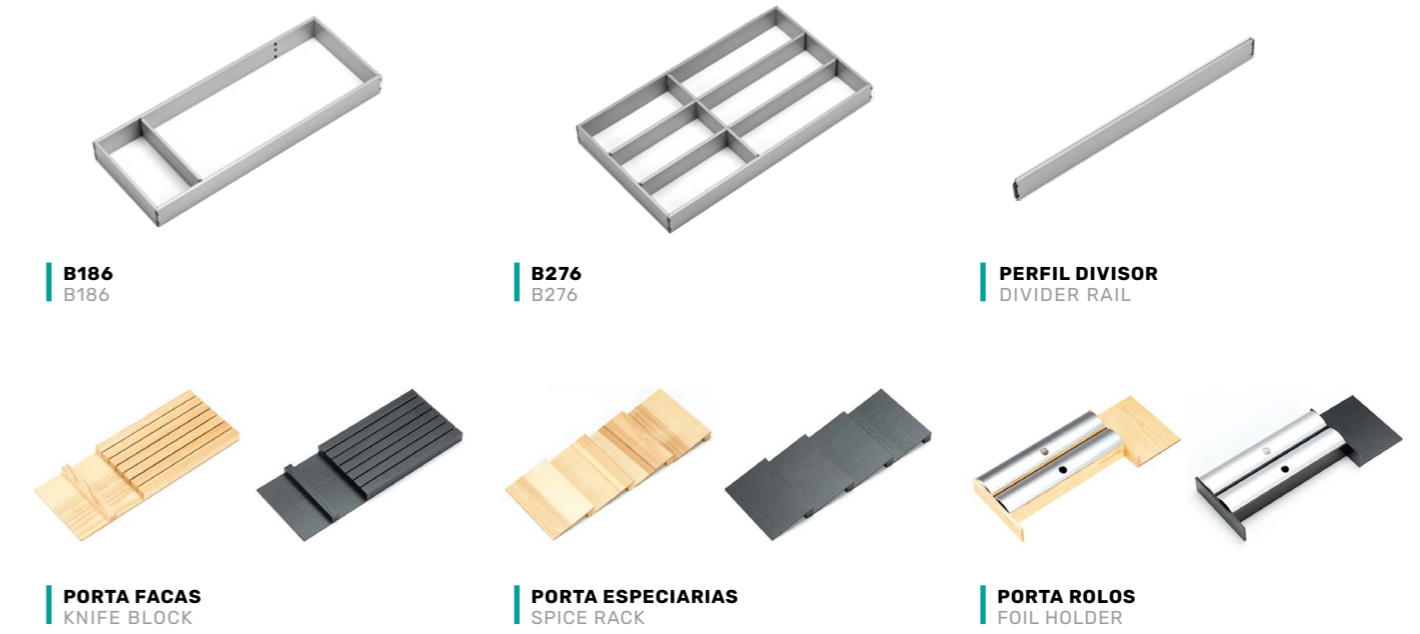

B186
B186

B276
B276

PERFIL DIVISOR
DIVIDER RAIL

PORTA FACAS
KNIFE BLOCK

PORTA ESPECIARIAS
SPICE RACK

PORTA ROLOS
FOIL HOLDER

MODELO MODEL	ACABAMENTO FINISH	CAIXA BOX	REFERÊNCIA REFERENCE
B186 B186	● ALUMÍNIO ALUMINIUM	01 UN	F 0071 3015 7201
	● ANTRACITE ANTHRACITE		F 0071 3015 8201
B276 B276	● ALUMÍNIO ALUMINIUM	01 UN	F 0071 3013 6201
	● ANTRACITE ANTHRACITE		F 0071 3013 7201
PERFIL DIVISOR DIVIDER RAIL	● ALUMÍNIO ALUMINIUM	01 UN	F 0071 3017 8207
	● ANTRACITE ANTHRACITE		F 0071 3017 9207
PORTA FACAS KNIFE BLOCK	● MADEIRA NATURAL LIGHT ASH	01 UN	F 0071 0241 8201
	● PRETO DARK ASH		F 0071 0242 4201
PORTA ESPECIARIAS SPICE RACK	● MADEIRA NATURAL LIGHT ASH	01 UN	F 0071 0242 0201
	● PRETO DARK ASH		F 0071 0242 6201
PORTA ROLOS FOIL HOLDER	● MADEIRA NATURAL LIGHT ASH	01 UN	F 0071 0242 2201
	● PRETO DARK ASH		F 0071 0242 8201

TAVINEA SORTO

i PARA GAVETAS COM PROFUNDIDADE DE 500MM
FOR 500MM DEPTH DRAWERS

GENERAL CATALOGUE

PORTA TALHERES
CUTLERY TRAY



**PORTA
TALHERES
CLÁSSICO**



PORTA TALHERES
CUTLERY TRAY

MODELO MODEL	MÓDULO CABINET	LARGURA WIDTH	PROFUNDIDADE DEPTH	ALTURA HEIGHT	CAIXA BOX	REFERÊNCIA REFERENCE
CLÁSSICO CINZENTO	MOD. 300	290	480	50.5	01 UN	K520001722
	MOD. 400	350				K520001822
	MOD. 450	390				K520001922
	MOD. 500	450				K520002022
	MOD. 550	490				K520002122
	MOD. 600	570				K520002222
	MOD. 700	670				K520002322
	MOD. 800	770				K520002422
	MOD. 900	870				K520002522
	MOD. 1000	970				K520002622
	MOD. 1100	1070				K520002722
	MOD. 1200	1170				K520002822
CLÁSSICO ANTRACITE	MOD. 300	290	480	50.5	01 UN	K520001724
	MOD. 400	350				K520001824
	MOD. 450	390				K520001924
	MOD. 500	450				K520002024
	MOD. 550	490				K520002124
	MOD. 600	570				K520002224
	MOD. 700	670				K520002324
	MOD. 800	770				K520002424
	MOD. 900	870				K520002524
	MOD. 1000	970				K520002624
	MOD. 1100	1070				K520002724
	MOD. 1200	1170				K520002824
CLÁSSICO BRANCO	MOD. 300	290	480	50.5	01 UN	K520001726
	MOD. 400	350				K520001826
	MOD. 450	390				K520001926
	MOD. 500	450				K520002026
	MOD. 550	490				K520002126
	MOD. 600	570				K520002226
	MOD. 700	670				K520002326
	MOD. 800	770				K520002426
	MOD. 900	870				K520002526
	MOD. 1000	970				K520002626
	MOD. 1100	1070				K520002726
	MOD. 1200	1170				K520002826



○ BRANCO
WHITE

● INOX
STAINLESS STEEL

● CARBONO
CARBON



● PRETO MATE
MATTE BLACK

● ARDÓSIA ANTRACITE
ANTHRACITE

MODELO MODEL	MÓDULO CABINET	ACABAMENTO FINISH	LARGURA WIDTH	ALTURA HEIGHT	CAIXA BOX	REFERÊNCIA REFERENCE
PERSIANAS ALUMÍNIO	MOD. 450	● ALUMÍNIO ALUMINIUM	450	900	01 UN	K520005001
			450	1470		K520005101
	MOD. 600		600	900		K520005201
			600	1470		K520005301
	MOD. 900		900	1470		K520005401
	MOD. 600		○ BRANCO MATE MATTE WHITE	600		1470
PERSIANAS PVC	MOD. 600	● ARDÓSIA ANTRACITE ANTHRACITE	600	1500	01 UN	K520016024
	MOD. 900	● ARDÓSIA ANTRACITE ANTHRACITE	900	1500	01 UN	K520016124
	MOD. 600	○ BRANCO MATE MATTE WHITE	600	1500	01 UN	K520016003
	MOD. 900	○ BRANCO MATE MATTE WHITE	900	1500	01 UN	K520016103
	MOD. 600	● CARBONO CARBON	600	1500	01 UN	K520016035
	MOD. 900	● CARBONO CARBON	900	1500	01 UN	K520016135
	MOD. 600	● INOX STAINLESS STEEL	600	1500	01 UN	K520016012
	MOD. 900	● INOX STAINLESS STEEL	900	1500	01 UN	K520016112
	MOD. 600	● PRETO MATE MATTE BLACK	600	1500	01 UN	K520016009
	MOD. 900	● PRETO MATE MATTE BLACK	900	1500	01 UN	K520016109

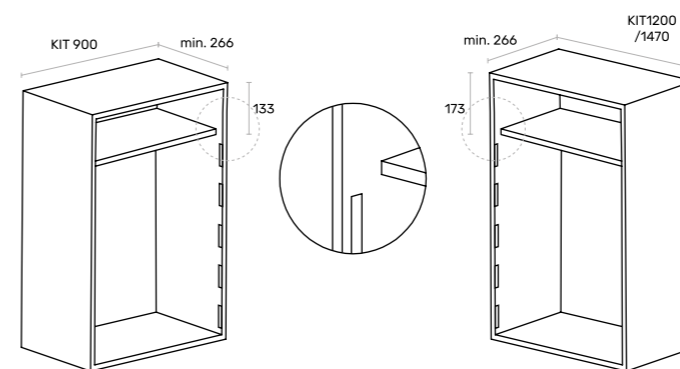
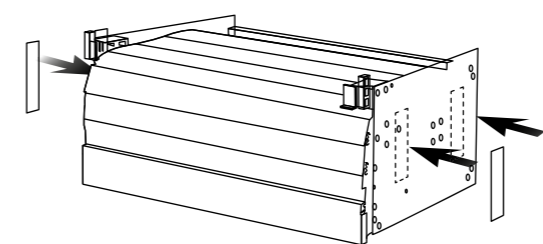

PERSIANAS ALUMÍNIO
ALUMINIUM ROLLER SHUTTER

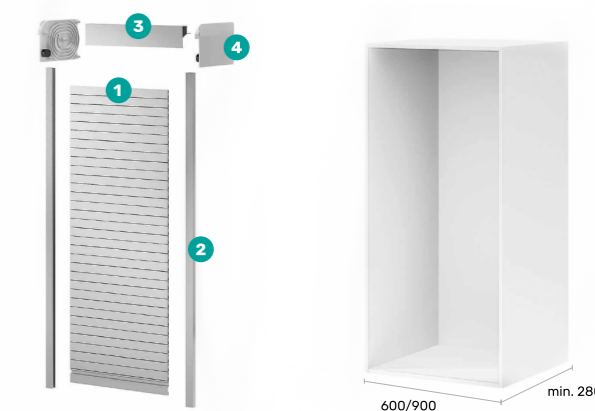

PERSIANAS PVC
PVC ROLLER SHUTTER

COMPASSO A GÁS
GAS SPRING

COMPASSO MICROONDAS
FLAP STAY

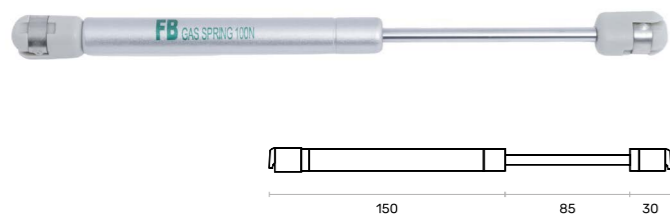

MODELO MODEL	CAPACIDADE CAPACITY	CAIXA BOX	REFERÊNCIA REFERENCE
COMPASSO A GÁS	50N	100 UN	K520006622
	80N		K520006722
	100N		K520006822
	120N		K520006922
	150N		K520007022
	200N		K520007122
COMPASSO A GÁS INVERTIDO	50N	100 UN	K520007222
	80N		K520007322
	100N		K520007422
	150N		K520007522
COMPASSO MICROONDAS	200N		K520007622
	01 A	600 - 800	K520006222
	01	800 - 1000	K520006322
	02	OBLÍQUO	K520006122

SISTEMA ELEVAÇÃO SQ
SQ LIFTING SYSTEM

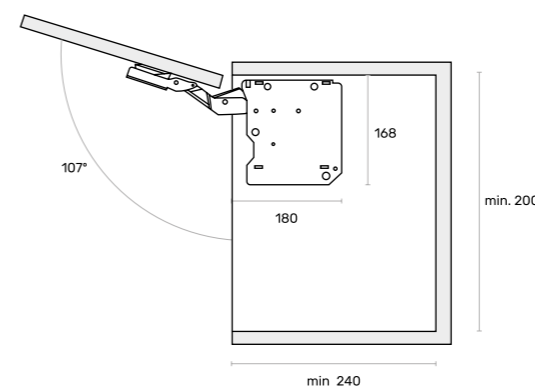

MODELO MODEL	ACABAMENTO FINISH	TIPO TYPE	CAPACIDADE CAPACITY	CAIXA BOX	REFERÊNCIA REFERENCE
SISTEMA DE ELEVAÇÃO SQ	● ANTRACITE ANTHRACITE	EXTRA-FORTE	2400/4500	01 UN	K520010124
		MÉDIO	960/2040		K520009924
		LEVE	580/1250		K520009824
	○ BRANCO WHITE	EXTRA-FORTE	2400/4500	01 UN	K520010102
		MÉDIO	960/2040		K520009902
		LEVE	580/1250		K520009802
LIMITADOR 75°		-	-	01 UN	K520010724

i CAPACIDADE = ALTURA(MM) X PESO
CAPACITY = HEIGHT(MM) X WEIGHT

SISTEMA DE ELEVAÇÃO SE
SE LIFTING SYSTEM

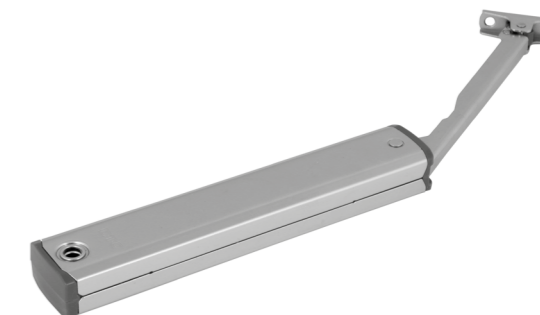
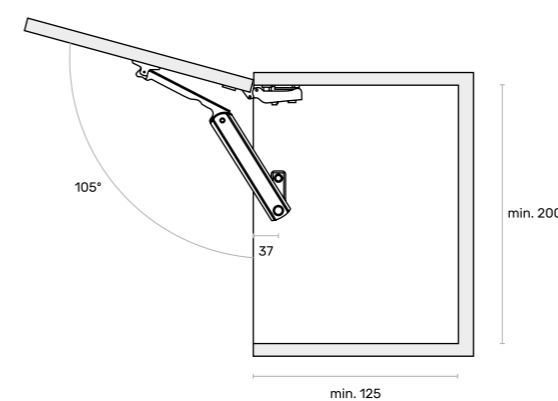

MODELO MODEL	CAPACIDADE CAPACITY	CAIXA BOX	REFERÊNCIA REFERENCE
SISTEMA DE ELEVAÇÃO SE	C/ AMORTECEDOR	01 UN	K520010320
	TIC-TAC	01 UN	K520010420

i CAPACIDADE = ALTURA(MM) X PESO
CAPACITY = HEIGHT(MM) X WEIGHT



COMPASSOS DUO
DUO FLAP SUPPORT



DUO STANDARD
CONSULTE TODA A INFORMAÇÃO TÉCNICA
FOR MORE TECHNICAL INFORMATION



DUO FORTE
CONSULTE TODA A INFORMAÇÃO TÉCNICA
FOR MORE TECHNICAL INFORMATION



MODELO MODEL	CAIXA (M) BOX (M)	REFERÊNCIA REFERENCE
COMPASSO DUO STANDARD	50 UN	K520007720
COMPASSO DUO FORTE		K520007820



FREEFLAP
FREEFLAP



FREEFLAP MINI
CONSULTE TODA
A INFORMAÇÃO TÉCNICA
FOR MORE TECHNICAL
INFORMATION



FREEFLAP FORTE
CONSULTE TODA
A INFORMAÇÃO TÉCNICA
FOR MORE TECHNICAL
INFORMATION

MODELO MODEL	TIPO TYPE	PESO WEIGHT	ALTURA HEIGHT	CAIXA BOX	REFERÊNCIA REFERENCE
FREEFLAP	MINI A	0.6 - 4.6	200 - 450		K520007922
	MINI B	1.4 - 7.9	200 - 450	01 UN	K520008022
	MINI C	2.7 - 14.7	200 - 450		K520008122
	FORTE D	2.6 - 11.0	350 - 650		K520008222
	FORTE E	3.4 - 14.3	350 - 650	01 UN	K520008322
	FORTE F	5.3 - 21.4	350 - 650		K520008422
	FORTE G	6.9 - 27.3	350 - 650		K520008522



FREESPACE
FREESPACE



FREESPACE
CONSULTE TODA
A INFORMAÇÃO TÉCNICA
FOR MORE TECHNICAL
INFORMATION

MODELO MODEL	ACABAMENTO FINISH	TIPO TYPE	PESO WEIGHT	ALTURA HEIGHT	CAIXA BOX	REFERÊNCIA REFERENCE
FREESPACE	● ANTRACITE ANTHRACITE	TIPO B	0.7 - 4.3			K520015024
		TIPO C	1.3 - 7.1			K520015124
		TIPO D	2.2 - 9.3	225 - 650	01 UN	K520015224
		TIPO E	3.2 - 13.4			K520015324
		TIPO F	4.6 - 19.1			K520015424

FREESLIDE
FREESLIDE



FREESLIDE
CONSULTE TODA
A INFORMAÇÃO TÉCNICA
FOR MORE TECHNICAL
INFORMATION



MODELO MODEL	TIPO TYPE	PESO WEIGHT	ALTURA HEIGHT	CAIXA BOX	REFERÊNCIA REFERENCE
FREESLIDE	P2	4.1 - 8.0	345 - 420		K520011122
	BARRA ESTABILIZADORA	600	-	01 UN	K520011900
		900	-		K520012000

FREEFOLD
FREEFOLD



MODELO MODEL	TIPO TYPE	PESO WEIGHT	ALTURA HEIGHT	CAIXA BOX	REFERÊNCIA REFERENCE
FREEFOLD	DOB. INTERMÉDIA FREEFOLD	-	-	01 UN	K520006520
	E3	4.3 - 8.8	580 - 650		K520008622
	E4	6.0 - 12.2	580 - 650		K520008722
	F3	3.9 - 7.9	650 - 730		K520008822
	F5	9.5 - 18.7	650 - 730		K520008922
	G4	5.2 - 10.3	710 - 790		K520009022
	G5	8.7 - 17.2	710 - 790	01 UN	K520009122
	H4	4.9 - 9.8	770 - 840		K520009222
	H5	8.0 - 15.5	770 - 840		K520009322
	I4	4.5 - 9.0	840 - 910		K520009422
	I5	7.3 - 14.6	840 - 910		K520009522
I6	10.0 - 20.0	840 - 910		K520009622	



FREEFOLD
CONSULTE TODA
A INFORMAÇÃO TÉCNICA
FOR MORE TECHNICAL
INFORMATION

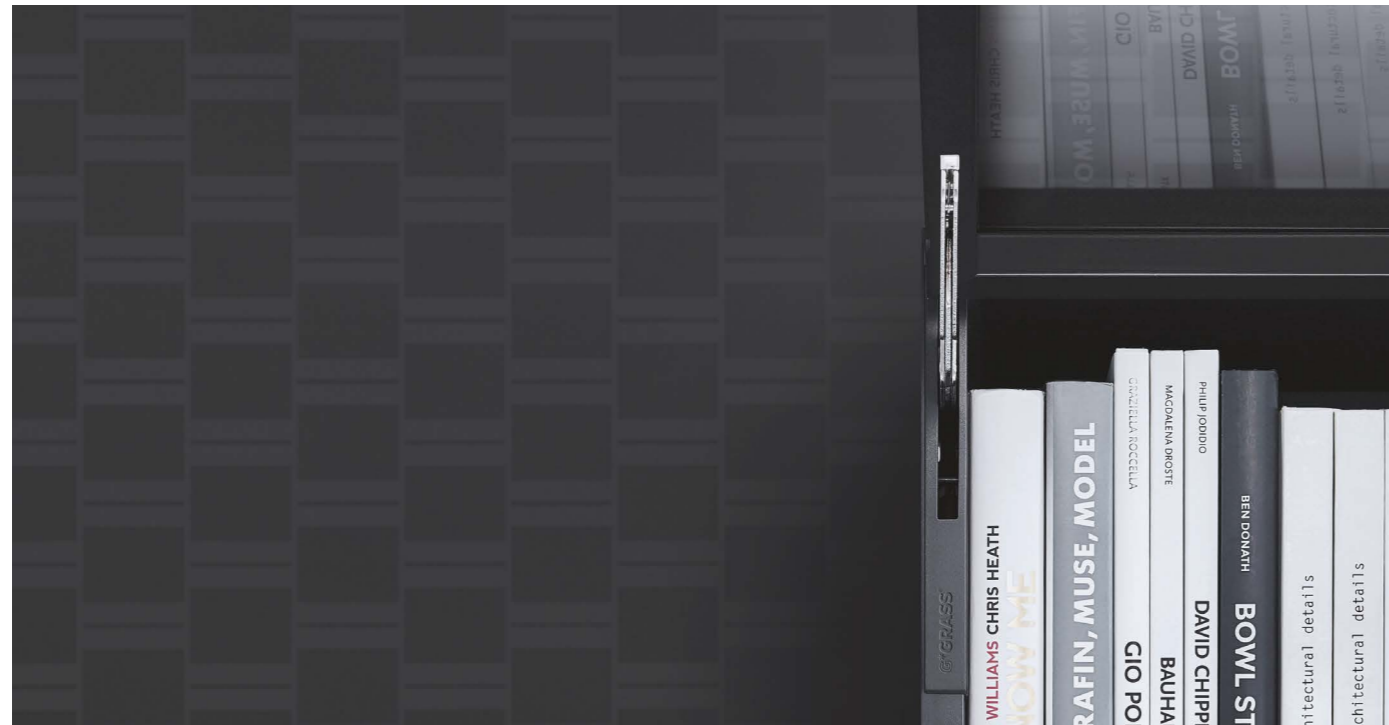

KINVARO T-65/71/76
KINVARO T-65/71/76



KINVARO T-65/71/76
CONSULTE TODA A INFORMAÇÃO
TÉCNICA DA PÁG. 258 À 263
P.258 TO 263 FOR MORE
TECHNICAL INFORMATION



MODELO MODEL	PESO WEIGHT	ALTURA HEIGHT	CAIXA BOX	REFERÊNCIA REFERENCE
KINVARO T-65	0.7 - 7.4	250 - 600		F 1511 4768 2201
KINVARO T-71	P/ MADEIRA	1.4 - 8.5	01 UN	F 1511 4769 6201
KINVARO T-76	5.2 - 11.0	400 - 600		F 1511 4770 6201



KINVARO T-SLIM
KINVARO T-SLIM

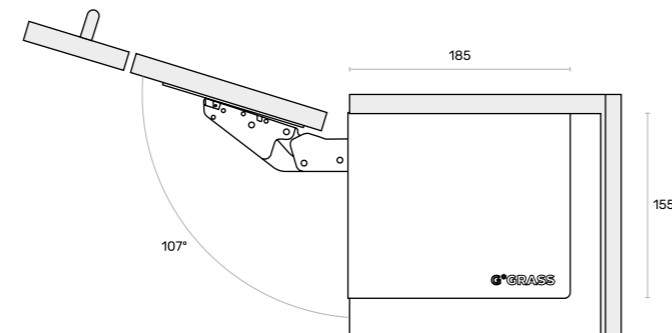

T-SLIM
CONSULTE TODA
A INFORMAÇÃO TÉCNICA
FOR MORE TECHNICAL
INFORMATION

MODELO MODEL	CAPACIDADE CAPACITY	CAIXA BOX	REFERÊNCIA REFERENCE
KINVARO T-SLIM	FS-500 - 1100		F 1511 4900 5201
	COM AMORTECEDOR	01 UN	F 1511 4900 8201
	FS-1500 - 3375		F 1511 4902 7201
	FS-500 - 1100		F 1511 4901 4201
	TIC-TAC	01 UN	F 1511 4901 7201
	FS-1500 - 3375		F 1511 4902 4201

KINVARO L-80
KINVARO L-80



KINVARO L-80
CONSULTE TODA A INFORMAÇÃO
TÉCNICA DA PÁG. 272 E 273
P.272 AND 273 FOR MORE
TECHNICAL INFORMATION

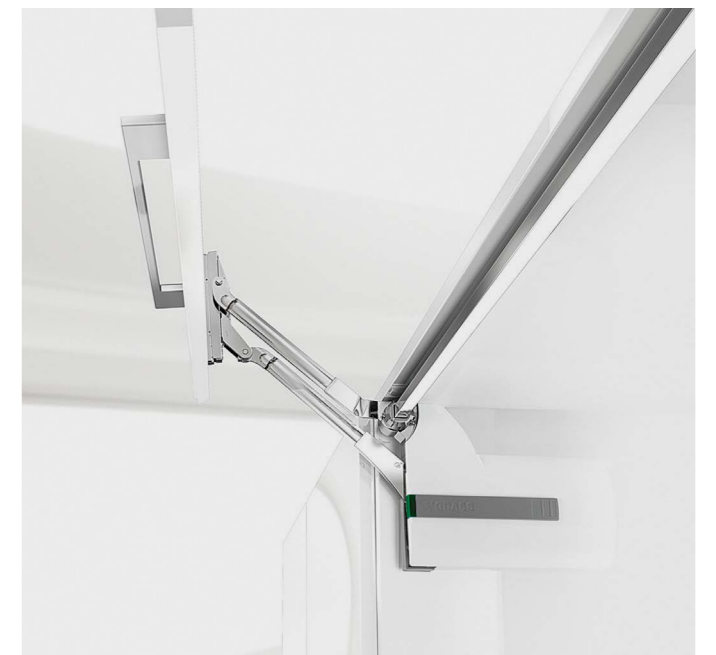

MODELO MODEL	TIPO TYPE	PESO WEIGHT	ALTURA HEIGHT	CAIXA BOX	REFERÊNCIA REFERENCE
KINVARO L-80	43/60 T5B MADEIRA	B	4.0 - 7.5		F 1521 4525 3201
	43/60 T5C MADEIRA	C	7.0 - 14.6	01 UN	F 1521 4525 4201

COMPASSO K12
K12 FLAP SUPPORT



MODELO MODEL	ACABAMENTO FINISH		CAPACIDADE CAPACITY	CAIXA BOX	REFERÊNCIA REFERENCE
COMPASSO K12	● GRAFITE GRAPHITE	L.164MM	80N	100 UN	48010460HX
	● GRAFITE GRAPHITE	L.244MM	80N 100N	50 UN	48020460HX 48020480HX
COMPASSO K12 INVERTIDO	● GRAFITE GRAPHITE	L.244MM	-	50 UN	48060200HX

SUPORTES K12
K12 SUPPORTS



LATERAL FURO Ø15 K12 SIDE BRACKET HOLE Ø15 | **P/ PORTA FURO Ø15** K12 DOOR BRACKET HOLE Ø15 | **LATERAL APARAFUSAR** K12 SIDE BRACKET SCREW | **P/PORTA APARAFUSAR** K12 DOOR BRACKET SCREW

MODELO MODEL	ACABAMENTO FINISH		CAIXA BOX	REFERÊNCIA REFERENCE
SUPORTES K12	● GRAFITE GRAPHITE	LATERAL (FURO Ø15)	50 UN	48040120HX
		P/ PORTA (FURO Ø15)		48040160HX
		LATERAL (APARAFUSAR)		48080120HX
		P/ PORTA (APARAFUSAR)		48080100HX

SET KIARO EASY
SET KIARO EASY



DOBRADIÇA KIMANA
KIMANA HINGE



MODELO MODEL	ACABAMENTO FINISH	CAIXA BOX	REFERÊNCIA REFERENCE
SET KIARO EASY FORTE	● ANTRACITE ANTHRACITE	01 UN	C010002605
DOBRADIÇA KIMANA	● GRAFITE GRAPHITE	150 UN	40120010HX
PARAFUSO MADEIRA 3,5X16	● GRAFITE GRAPHITE	01 UN	60101390HX

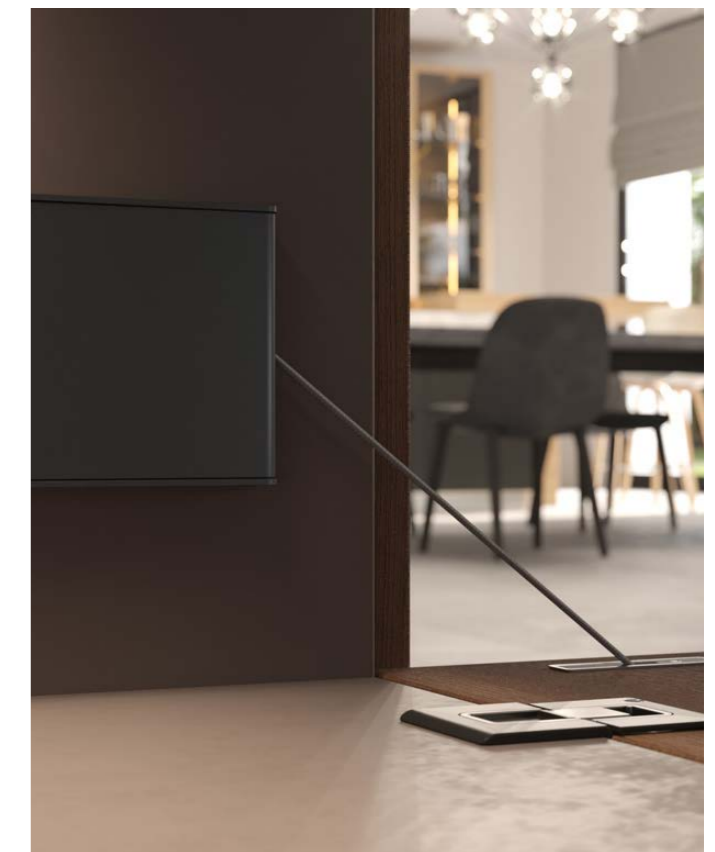

03

ASAS E PUXADORES HANDLES AND KNOBS

44 PUXADORES EDGE
EDGE HANDLES

48 ASAS PARA MÓVEIS
DOOR HANDLES

55 PUXADORES PARA MÓVEIS
KNOBS

56 CONCHAS PARA MÓVEIS
FURNITURE HANDLES

EDGE

PUXADORES EDGE EDGE HANDLES

EXEMPLO REFERÊNCIA
REFERENCE EXAMPLE

MODELO
MODEL

A494004501

ACABAMENTO
FINISHING

MEDIDA TOTAL (MM)
TOTAL MEASURE (MM)

01 ANODIZADO
ANODIZED

08 PRETO BRILHO
BRIGHT BLACK

02 BRANCO BRILHO
BRIGHT WHITE

09 PRETO MATE
MATTE BLACK

03 BRANCO MATE
MATTE WHITE

29 ALTO BRILHO
SHINE

MEDIDA TOTAL (MM) TOTAL MEASURE (MM)	0045	0348	0698	1298
	0104	0398	0798	1398
	0150	0448	0898	1498
	0198	0498	0998	1598
	0248	0548	1098	1698
	0298	0598	1198	1798

PUXADOR 07 HANDLE 07

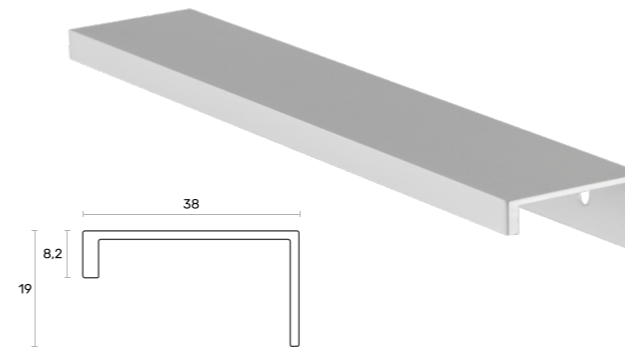

PUXADOR 12 HANDLE 12

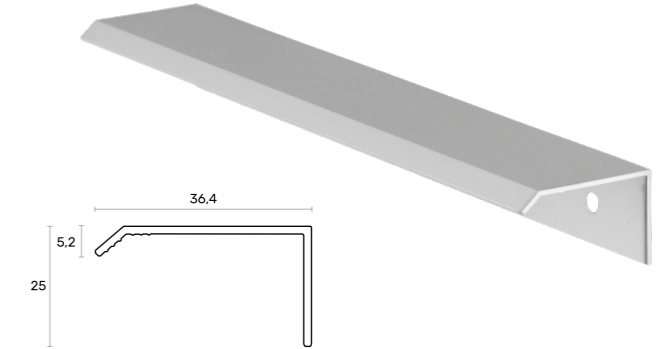

MODELO MODEL	ACABAMENTO FINISHING	MEDIDA MÁXIMA MAX. MEASURE	CAIXA BOX	REFERÊNCIA REFERENCE
PUXADOR 07 E PUXADOR 12	BRANCO MATE MATTE WHITE	5000 MM	01 UN	A407 0045 03 / A412 0045 03
	BRANCO BRILHO BRIGHT WHITE	5000 MM		A407 0045 02 / A412 0045 02
	PRETO MATE MATTE BLACK	5000 MM		A407 0045 09 / A412 0045 09
	PRETO BRILHO BRIGHT BLACK	5000 MM		A407 0045 08 / A412 0045 08
	ANODIZADO ANODIZED	5000 MM		A407 0045 01 / A412 0045 01

PUXADOR 03 HANDLE 03

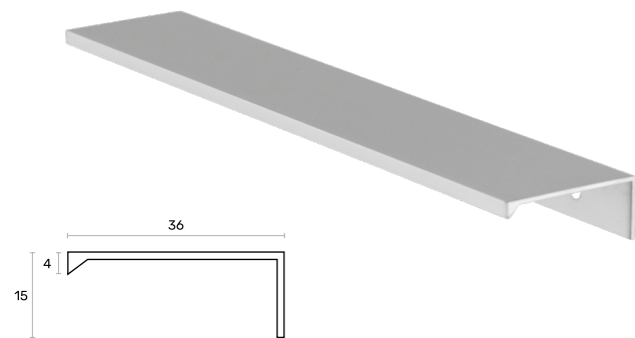

PUXADOR 05 HANDLE 05

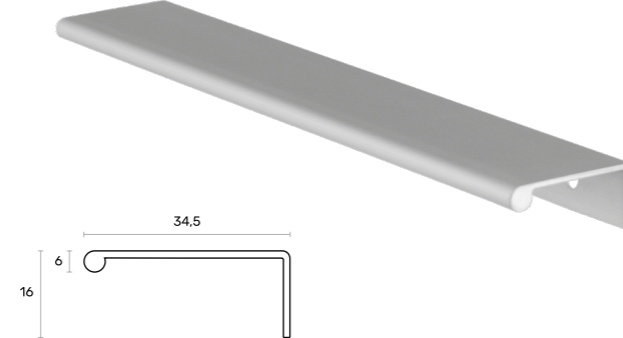

MODELO MODEL	ACABAMENTO FINISHING	MEDIDA MÁXIMA MAX. MEASURE	CAIXA BOX	REFERÊNCIA REFERENCE
PUXADOR 03 E PUXADOR 05	BRANCO MATE MATTE WHITE	3000 MM	01 UN	A403 0045 03 / A405 0045 03
	BRANCO BRILHO BRIGHT WHITE	3000 MM		A403 0045 02 / A405 0045 02
	PRETO MATE MATTE BLACK	3000 MM		A403 0045 09 / A405 0045 09
	PRETO BRILHO BRIGHT BLACK	3000 MM		A403 0045 08 / A405 0045 08
	ANODIZADO ANODIZED	3000 MM / 5000 MM		A403 0045 01 / A405 0045 01
	ALTO BRILHO SHINE	3000 MM		A403 0045 29

PUXADOR 34 HANDLE 34

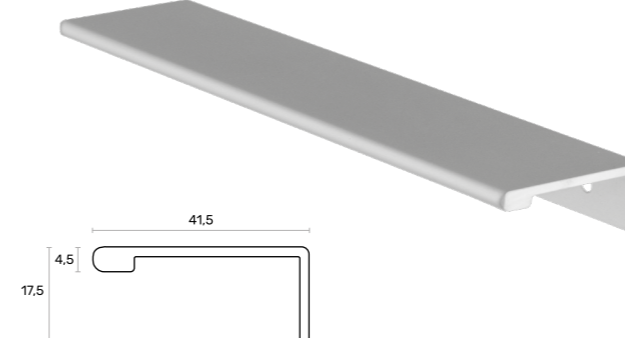

PUXADOR 94 HANDLE 94

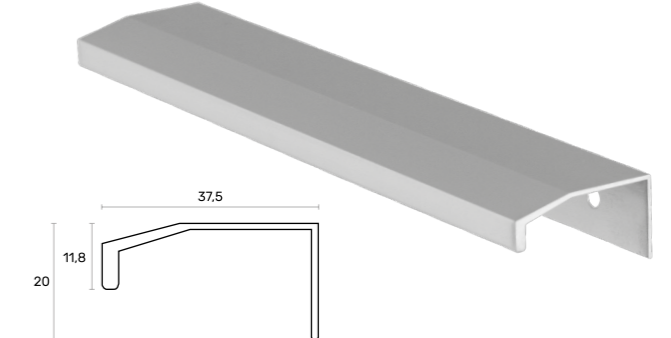

MODELO MODEL	ACABAMENTO FINISHING	MEDIDA MÁXIMA MAX. MEASURE	CAIXA BOX	REFERÊNCIA REFERENCE
PUXADOR 34 E PUXADOR 94	BRANCO MATE MATTE WHITE	5000 MM	01 UN	A434 0045 03 / A494 0045 03
	BRANCO BRILHO BRIGHT WHITE	5000 MM		A434 0045 02 / A494 0045 02
	PRETO MATE MATTE BLACK	5000 MM		A434 0045 09 / A494 0045 09
	PRETO BRILHO BRIGHT BLACK	5000 MM		A434 0045 08 / A494 0045 08
	ANODIZADO ANODIZED	5000 MM		A434 0045 01 / A494 0045 01

PUXADORES EDGE

EDGE HANDLES

PUXADOR 09 - A

HANDLE 09 - A

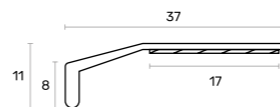
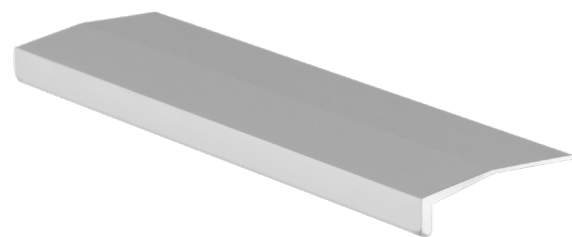

MODELO MODEL	ACABAMENTO FINISHING	MEDIDA TOTAL TOTAL MEASURE	CAIXA BOX	REFERÊNCIA REFERENCE
PUXADOR 09-A	● ANODIZADO ANODIZED	65 MM	01 UN	A409006501A
		90 MM		A409009001A
		150 MM		A409015001A
		3000 MM		A409300001A
		4000 MM		A409400001A
		5000 MM		A409500001A

! PARA PORTAS DE ALUMÍNIO / COM AUTOCOLANTE
FOR ALUMINUM DOORS / WITH STICKER

PUXADOR N°1

HANDLE N°1

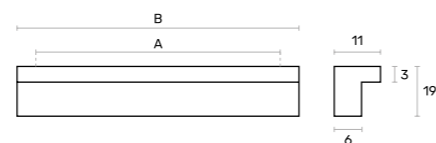
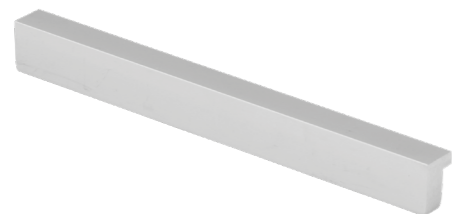

MODELO MODEL	ACABAMENTO FINISHING	MEDIDA ENTRE FUROS MEASURE BETWEEN HOLES	MEDIDA TOTAL TOTAL MEASURE	CAIXA BOX	REFERÊNCIA REFERENCE
N°1	● ANODIZADO ANODIZED	32	52	05 UN	A400007201
		64	84		A400007301
		96	116		A400007401
		128	148		A400007501
		160	180		A400007601
		192	212		A400007701
		-	5000		10 UN

* TAMBÉM PRODUZIMOS À MEDIDA.

A MEDIDA ENTRE FUROS
MEASURE BETWEEN HOLES

B MEDIDA TOTAL
TOTAL MEASURE

M4 INCLUIDOS
M4 INCLUDED

PUXADORES EDGE

EDGE HANDLES

PUXADOR J2

J2 HANDLE

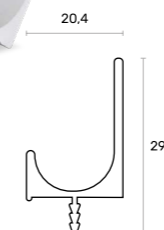

PUXADOR J2Q

J2Q HANDLE

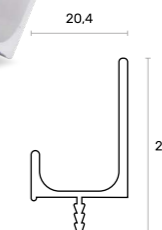

PUXADOR U2

U2 HANDLE

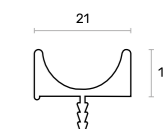

MODELO MODEL	ACABAMENTO FINISHING	COMPRIMENTO TOTAL TOTAL LENGTH	CAIXA BOX	REFERÊNCIA REFERENCE
PUXADOR J2	○ BRANCO MATE MATTE WHITE	5000	10 UN	A4J2 0045 03
	○ BRANCO BRILHO BRIGHT WHITE			A4J2 0045 02
	● ANODIZADO ANODIZED			A4J2 0045 01
	● PRETO MATE MATTE BLACK			A4J2 0045 09
PUXADOR J2Q	○ PRETO BRILHO BRIGHT BLACK	5000	10 UN	A4J2 0045 08
	○ BRANCO BRILHO BRIGHT WHITE			A4J2 0045 02
PUXADOR U2	● ANODIZADO ANODIZED	3000	10 UN	A4U2 0045 01

PUXADORES J3 E U3

J3 AND U3 HANDLES

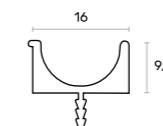
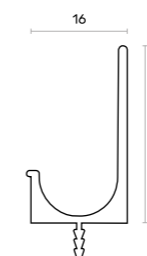

MODELO MODEL	ACABAMENTO FINISHING	COMPRIMENTO TOTAL TOTAL LENGTH	CAIXA BOX	REFERÊNCIA REFERENCE
PUXADOR J3	● ANODIZADO ANODIZED	5000	10 UN	A4J3 0045 01
PUXADOR U3				A4U3 0045 01

ASAS PARA MÓVEIS

DOOR HANDLES

ASA 216

HANDLE 216

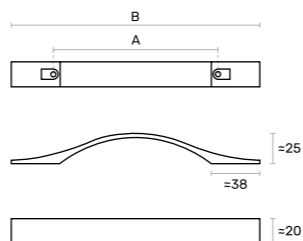
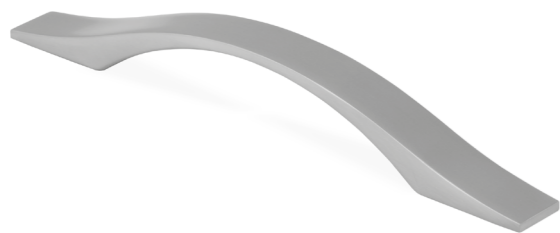

MODELO MODEL	ACABAMENTO FINISHING	MEDIDA ENTRE FUROS MEASURE BETWEEN HOLES	MEDIDA TOTAL TOTAL MEASURE	CAIXA BOX	REFERÊNCIA REFERENCE
216	BSN BSN	128	197	300 UN / 30 UN	A400001113
		160	229	400 UN / 40 UN	A400001213

A MEDIDA ENTRE FUROS
MEASURE BETWEEN HOLES

B MEDIDA TOTAL
TOTAL MEASURE

M4 INCLUIDOS
M4 INCLUDED

ASA 1.6

HANDLE 1.6

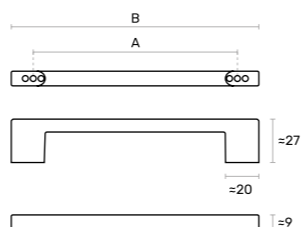
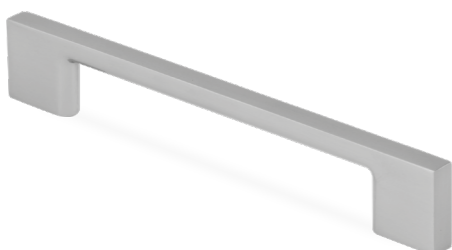

MODELO MODEL	ACABAMENTO FINISHING	MEDIDA ENTRE FUROS MEASURE BETWEEN HOLES	MEDIDA TOTAL TOTAL MEASURE	CAIXA BOX	REFERÊNCIA REFERENCE
1.6	BSN BSN	96	123	350 UN / 35 UN	A400014613
	PRETO MATE BLACK	128	155	300 UN / 30 UN	A400012009
	BSN BSN				A400012013
	PRETO MATE BLACK	160	188	300 UN / 30 UN	A400012109
	BSN BSN	192	223	200 UN / 20 UN	A400012113
	PRETO MATE BLACK				A400012209
	BSN BSN	224	251	210 UN / 35 UN	A400012213
	BSN BSN				A400012313
BSN BSN	256	287	120 UN / 20 UN	A400012413	
BSN BSN	320	353	120 UN / 20 UN	A400012513	

A MEDIDA ENTRE FUROS
MEASURE BETWEEN HOLES

B MEDIDA TOTAL
TOTAL MEASURE

M4 INCLUIDOS
M4 INCLUDED

ASAS PARA MÓVEIS

DOOR HANDLES

ASA 220

HANDLE 220

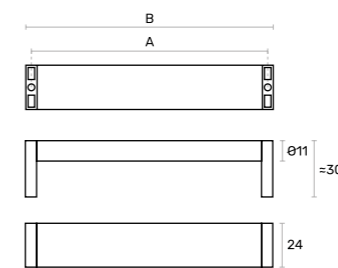
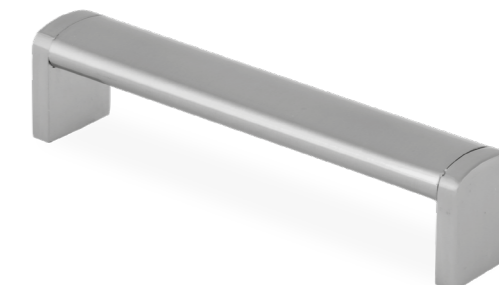

MODELO MODEL	ACABAMENTO FINISHING	MEDIDA ENTRE FUROS MEASURE BETWEEN HOLES	MEDIDA TOTAL TOTAL MEASURE	CAIXA BOX	REFERÊNCIA REFERENCE
220	BSN BSN	128	134	150 UN / 15 UN	A400000113
		160	166		A400000213
		192	198	100 UN / 10 UN	A400000313
		256	262	90 UN / 15 UN	A400000513
		320	326		A400000613

A MEDIDA ENTRE FUROS
MEASURE BETWEEN HOLES

B MEDIDA TOTAL
TOTAL MEASURE

M4 INCLUIDOS
M4 INCLUDED

ASA 503

HANDLE 503

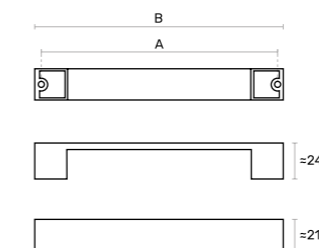
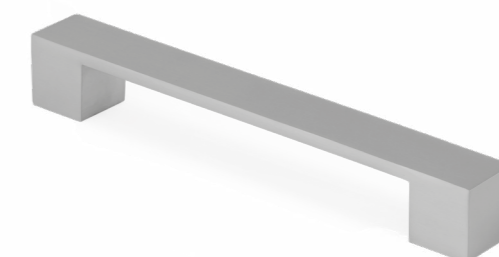

MODELO MODEL	ACABAMENTO FINISHING	MEDIDA ENTRE FUROS MEASURE BETWEEN HOLES	MEDIDA TOTAL TOTAL MEASURE	CAIXA BOX	REFERÊNCIA REFERENCE
503	BSN BSN	160	168	200 UN / 20 UN	A400011813
	CROMADO MATE MATT CHROME PLATED				A400011818
	BSN BSN	192	201	150 UN / 25 UN	A400011913
	CROMADO MATE MATT CHROME PLATED				A400011918

A MEDIDA ENTRE FUROS
MEASURE BETWEEN HOLES

B MEDIDA TOTAL
TOTAL MEASURE

M4 INCLUIDOS
M4 INCLUDED

ASAS PARA MÓVEIS

DOOR HANDLES

ASA 628

HANDLE 628

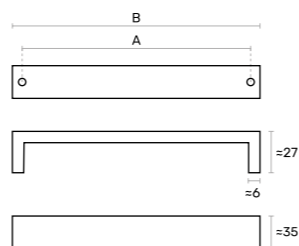
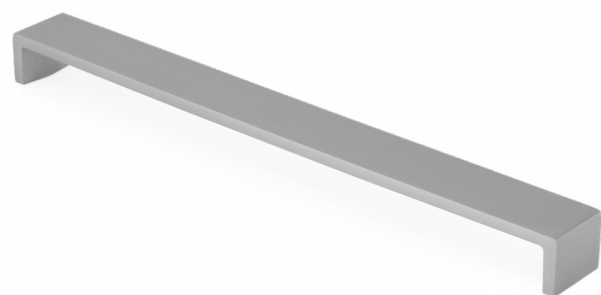

MODELO MODEL	ACABAMENTO FINISHING	MEDIDA ENTRE FUROS MEASURE BETWEEN HOLES	MEDIDA TOTAL TOTAL MEASURE	CAIXA BOX	REFERÊNCIA REFERENCE
628	BSN BSN	320	329	60 UN / 15 UN	A400013313

A MEDIDA ENTRE FUROS
MEASURE BETWEEN HOLES

B MEDIDA TOTAL
TOTAL MEASURE

M4 INCLUIDOS
M4 INCLUDED

ASA 303

HANDLE 303

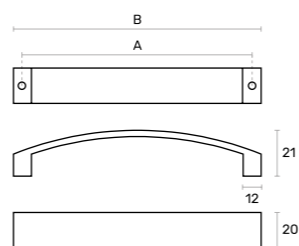

MODELO MODEL	ACABAMENTO FINISHING	MEDIDA ENTRE FUROS MEASURE BETWEEN HOLES	MEDIDA TOTAL TOTAL MEASURE	CAIXA BOX	REFERÊNCIA REFERENCE
303	PRETO MATE BLACK	128	140	250 UN / 25 UN	A400012809
	BSN BSN				A400012813
	CROMADO MATE MATT CHROME PLATED	A400012818			
	BRANCO MATE MATTE WHITE	A400012903			
	PRETO MATE BLACK	160	172	200 UN / 20 UN	A400012909
	BSN BSN	A400012913			
	BSN BSN	192	204	125 UN / 25 UN	A400013013

A MEDIDA ENTRE FUROS
MEASURE BETWEEN HOLES

B MEDIDA TOTAL
TOTAL MEASURE

M4 INCLUIDOS
M4 INCLUDED

ASAS PARA MÓVEIS

DOOR HANDLES

ASA 001

HANDLE 001

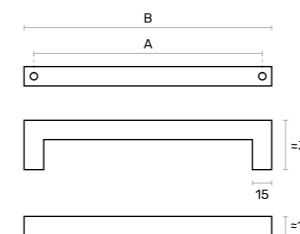
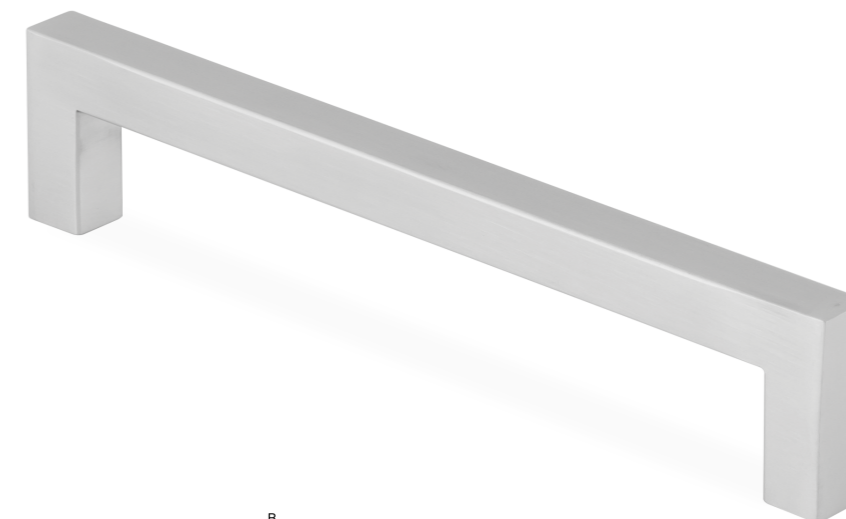

∅15 ASA 001
HANDLE 001

∅12 ASA 5896
HANDLE 5896

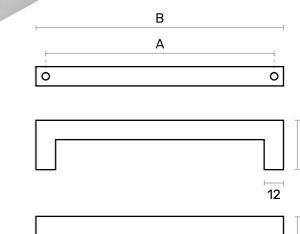

MODELO MODEL	ACABAMENTO FINISHING	MEDIDA ENTRE FUROS MEASURE BETWEEN HOLES	MEDIDA TOTAL TOTAL MEASURE	CAIXA BOX	REFERÊNCIA REFERENCE	
001	BSN BSN	192	206	200 UN / 50 UN	A400011512	
		256	270		A400011612	
		128	140	A400005212		
		160	172	A400005312		
		192	204	200 UN / 50 UN	A400005412	
	5896	BSN BSN	224	236	A400005512	
			256	268	A400005612	
			288	300	A400005712	
			320	332	10 UN	A400005812
			480	492	A400005912	
OURO ESCOVADO BRUSHED GOLD		640	652	A400006012		
		160	172	10 UN	A400005334	
		320	332	A400005834		

A MEDIDA ENTRE FUROS
MEASURE BETWEEN HOLES

B MEDIDA TOTAL
TOTAL MEASURE

M4 INCLUIDOS
M4 INCLUDED

ASAS PARA MÓVEIS

DOOR HANDLES

ASAS PARA MÓVEIS

DOOR HANDLES

ASA 101
HANDLE 101

ASA H10
HANDLE H10

ASA H12
HANDLE H12

ASA BA
HANDLE BA

ASA PONTE QUADRADA
SQUARE BRIDGE HANDLE

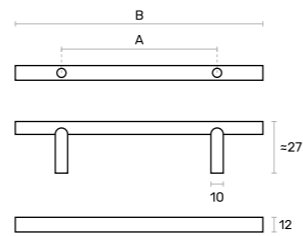
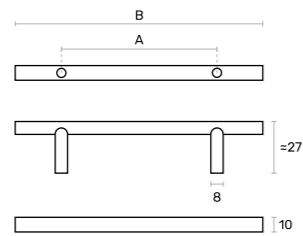
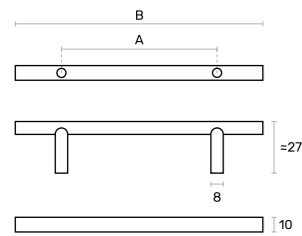
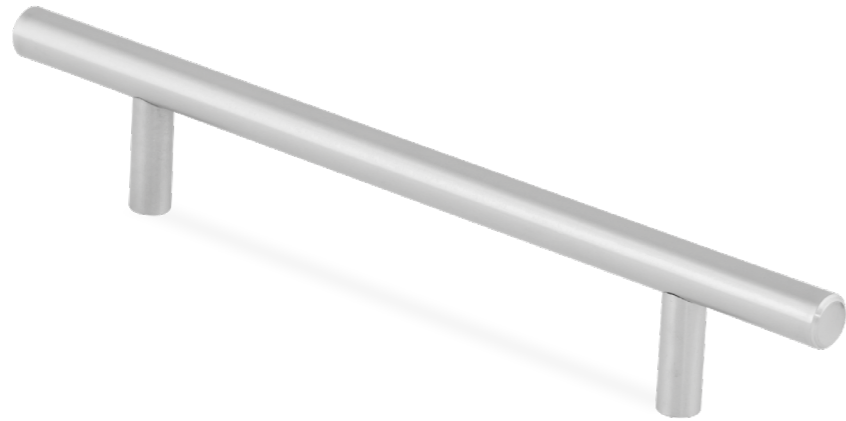

Ø10 INOX SÓLIDO
SOLID STAINLESS STEEL

Ø10 INOX ÔCO
HOLLOW STAINLESS STEEL

Ø12 INOX ÔCO
HOLLOW STAINLESS STEEL

MODELO MODEL	ACABAMENTO FINISHING	MEDIDA ENTRE FUROS MEASURE BETWEEN HOLES	MEDIDA TOTAL TOTAL MEASURE	CAIXA BOX	REFERÊNCIA REFERENCE
101	INOX STAINLESS STEEL	96	161	100 UN / 25 UN	A400002912
		128	193		A400003012
		160	225		A400003112
		192	257		A400003212
		224	289		A400003312
		256	321		A400003412
		320	385		A400003512
H10	INOX STAINLESS STEEL	96	159	400 UN / 50 UN	A400003612
		128	191	500 UN / 50 UN	A400003712
		160	223	400 UN / 50 UN	A400003812
		192	255	400 UN / 50 UN	A400003912
		224	287	400 UN / 50 UN	A400004012
		256	319	300 UN / 50 UN	A400004112
H12	INOX STAINLESS STEEL	320	383	200 UN / 50 UN	A400004312
		128	191	500 UN / 50 UN	A400004512
		160	223	300 UN / 50 UN	A400004612
		192	255	300 UN / 50 UN	A400004712
		256	319	300 UN / 50 UN	A400004912
320	383	200 UN / 50 UN	A400005112		

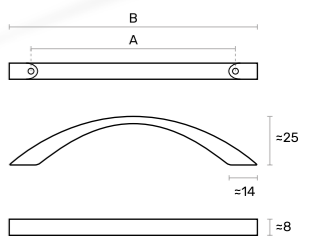
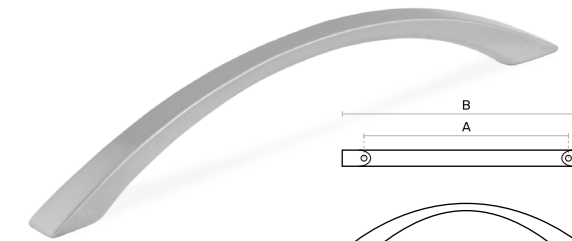
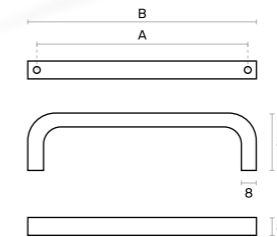
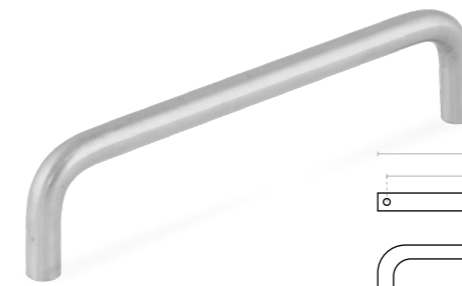

MODELO MODEL	ACABAMENTO FINISHING	MEDIDA ENTRE FUROS MEASURE BETWEEN HOLES	MEDIDA TOTAL TOTAL MEASURE	CAIXA BOX	REFERÊNCIA REFERENCE
BA	INOX STAINLESS STEEL	96	104	05 UN	A400006412
		128	136		A400006512
		160	168		A400006612
		192	192		A400006712
		224	232		A400006812
		256	264		A400006912
PONTE QUADRADA	NIQUELADO ESCOVADO BRUSHED NICKEL	96	113	05 UN	A400007014
		128	145		A400007115
	BRONZE BRASS	96	113		A400007015
		128	145		A400007114

A MEDIDA ENTRE FUROS
MEASURE BETWEEN HOLES

B MEDIDA TOTAL
TOTAL MEASURE

M4 INCLUIDOS
M4 INCLUDED

ASA 1050 / 1060
HANDLE 1050 / 1060

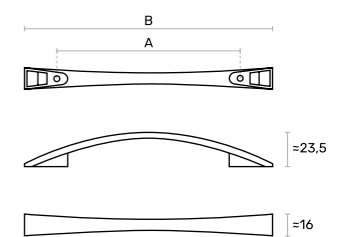

MODELO MODEL	ACABAMENTO FINISHING	MEDIDA ENTRE FUROS MEASURE BETWEEN HOLES	MEDIDA TOTAL TOTAL MEASURE	CAIXA BOX	REFERÊNCIA REFERENCE
1050	BSN BSN	128	169	300 UN / 30 UN	A400001313
	BRONZE BRASS				A400001315
1060	BSN BSN	160	204	250 UN / 25 UN	A400001413
	BRONZE BRASS				A400001415

A MEDIDA ENTRE FUROS
MEASURE BETWEEN HOLES

B MEDIDA TOTAL
TOTAL MEASURE

M4 INCLUIDOS
M4 INCLUDED

ASAS PARA MÓVEIS

DOOR HANDLES

PUXADORES PARA MÓVEIS

KNOBBS

ASA 133

HANDLE 133

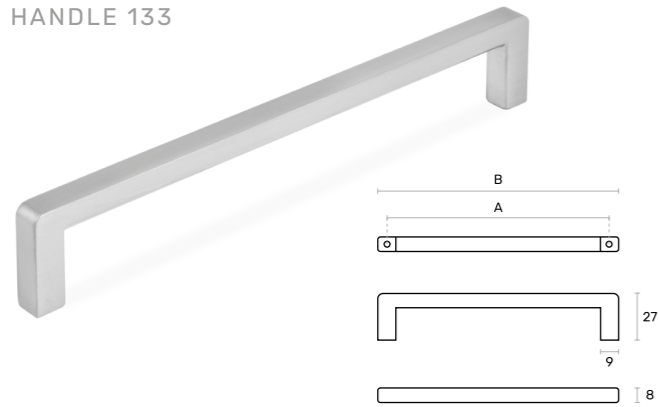

ASA J57

HANDLE J57

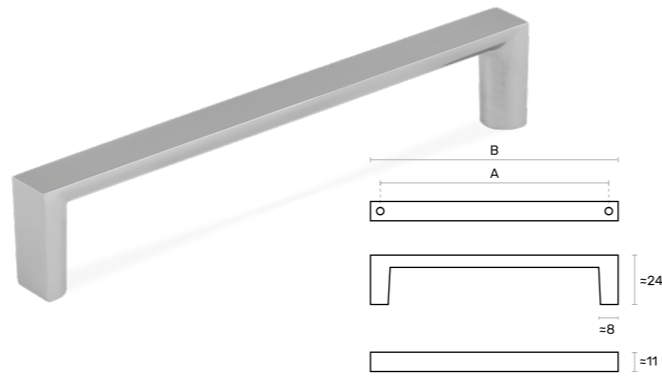

MODELO MODEL	ACABAMENTO FINISHING	MEDIDA ENTRE FUROS MEASURE BETWEEN HOLES	MEDIDA TOTAL TOTAL MEASURE	CAIXA BOX	REFERÊNCIA REFERENCE
133	● PRETO MATE BLACK	128	137	300 UN / 30 UN	A400017209
	● BSN BSN				A400017213
	○ BRANCO MATE MATTE WHITE	160	169	250 UN / 25 UN	A400017303
	● OURO BRILHO BRIGHT GOLD				A400017306
	● PRETO MATE MATTE BLACK	192	201	200 UN / 20 UN	A400017309
	● BSN BSN				A400017313
	○ BRANCO MATE MATTE WHITE	256	262	20 UN	A400017403
	● PRETO MATE BLACK				A400017409
● BSN BSN	A400017413				
J57	● BSN BSN	128	134		A400032013
		160	166		A400032113
		192	198		A400032213
		256	262		A400032413

A MEDIDA ENTRE FUROS
MEASURE BETWEEN HOLES

B MEDIDA TOTAL
TOTAL MEASURE

M4 INCLUIDOS
M4 INCLUDED

ASA 246

HANDLE 246

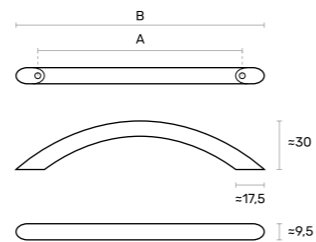

MODELO MODEL	ACABAMENTO FINISHING	MEDIDA ENTRE FUROS MEASURE BETWEEN HOLES	MEDIDA TOTAL TOTAL MEASURE	CAIXA BOX	REFERÊNCIA REFERENCE
246	● PRETO MATE MATTE BLACK	128	155	300 UN / 30 UN	A400012709
	● BSN BSN				A400012613

A MEDIDA ENTRE FUROS
MEASURE BETWEEN HOLES

B MEDIDA TOTAL
TOTAL MEASURE

M4 INCLUIDOS
M4 INCLUDED

PUXADOR N°2

HANDLE N°2



MODELO MODEL	ACABAMENTO FINISHING	MEDIDA ENTRE FUROS MEASURE BETWEEN HOLES	MEDIDA TOTAL TOTAL MEASURE	CAIXA BOX	REFERÊNCIA REFERENCE
N°2	● ANODIZADO ANODIZED	32	72	05 UN	A400007801
		64	104		A400007901
		96	136		A400008001
		128	168		A400008101
		160	200		A400008201

i TAMANHO PERSONALIZÁVEL
ALL SIZES

PUXADOR 1007

KNOB 1007

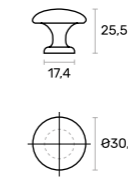

FACETADO REDONDO / QUADRADO

ROUND FACETADO / SQUARE FACETADO

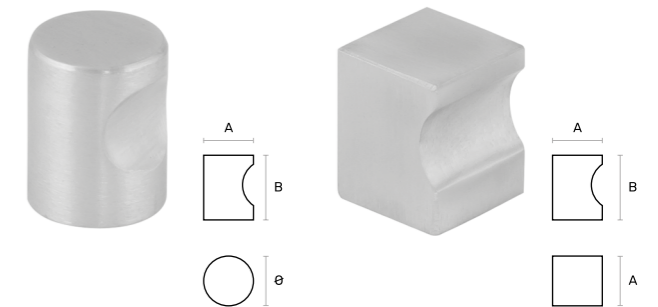

MODELO MODEL	ACABAMENTO FINISHING	MEDIDA TOTAL TOTAL MEASURE	CAIXA BOX	REFERÊNCIA REFERENCE
1007	● BSN BSN	Ø30	500 UN / 50 UN	A400011713
	● BRONZE BRASS			A400011715
REDONDO	● INOX STAINLESS STEEL	Ø12 - 20	100 UN	A400008912
		Ø15 - 22		A400009012
		Ø18 - 22		A400009112
		Ø20 - 24		A400009212
		Ø25 - 28		A400009312
QUADRADO	● INOX STAINLESS STEEL	15 - 22	40 UN	A400009412
		18 - 24	40 UN	A400009512
		20 - 25	30 UN	A400009612

M4 INCLUIDOS
M4 INCLUDED

CONCHAS PARA MÓVEIS

KNOBS

CONCHAS PARA MÓVEIS

KNOBS

CONCHA 4520

KNOB 4520

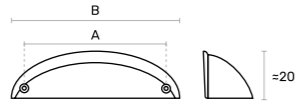

CONCHA 177

KNOB 177

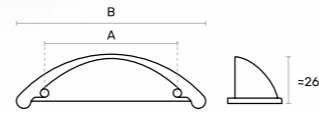

MODELO MODEL	ACABAMENTO FINISHING	MEDIDA ENTRE FUROS MEASURE BETWEEN HOLES	MEDIDA TOTAL TOTAL MEASURE	CAIXA BOX	REFERÊNCIA REFERENCE
4520	CROMADO MATE MATT CHROME PLATED	64	82	01 UN	A400008718
	BRONZE VELHO OLD BRASS				A400008716
177	BRANCO MATE MATTE WHITE	64	104	300 UN / 30 UN	A400017703
	OURO BRILHO BRIGHT GOLD				A400017706
	PRETO MATE MATTE BLACK				A400017709
	BSN BSN				A400017713
	BRONZE BRASS				A400017715
	BRONZE VELHO OLD BRASS		A400017716		

A MEDIDA ENTRE FUROS
MEASURE BETWEEN HOLES

B MEDIDA TOTAL
TOTAL MEASURE

M4 INCLUIDOS
M4 INCLUDED

CONCHA S70

RECESSED HANDLE S70

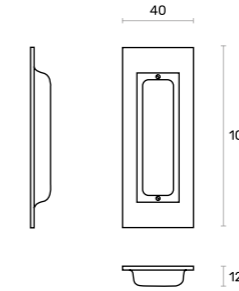

CONCHA S71

RECESSED HANDLE S71

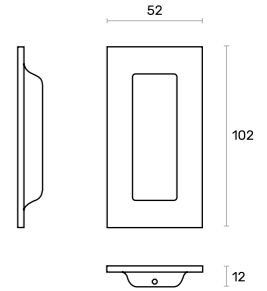

MODELO MODEL	ACABAMENTO FINISHING	MEDIDA ENTRE FUROS MEASURE BETWEEN HOLES	MEDIDA TOTAL TOTAL MEASURE	CAIXA BOX	REFERÊNCIA REFERENCE
S70	BSN BSN	-	102X40X12	300 UN / 30 UN	A400017813
	BRANCO MATE MATTE WHITE				A400017903
S71	BSN BSN	-	102X52X13	200 UN / 10 UN	A400017913
	PRETO MATE MATTE BLACK				A400017909

CONCHA 02

RECESSED HANDLE 02

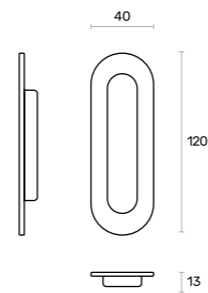
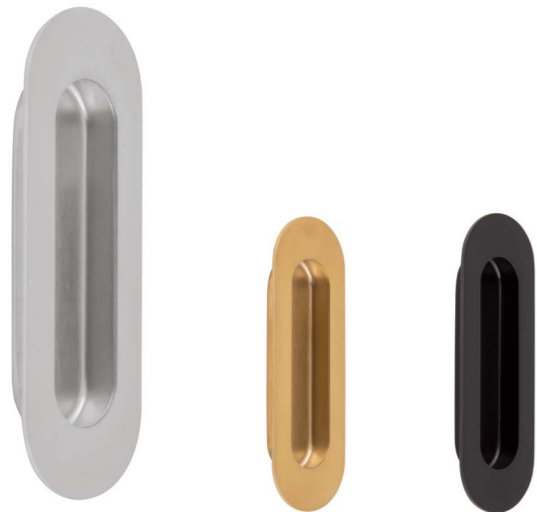

MODELO MODEL	ACABAMENTO FINISHING	MEDIDA ENTRE FUROS MEASURE BETWEEN HOLES	MEDIDA TOTAL TOTAL MEASURE	CAIXA BOX	REFERÊNCIA REFERENCE
S72	PRETO MATE MATTE BLACK	-	120X40X13	200 UN / 10 UN	A400018109
	BSN BSN				A400018113
	OURO ESCOVADO BRUSHED GOLD				A400018134



MODELO MODEL	ACABAMENTO FINISHING	MEDIDA ENTRE FUROS MEASURE BETWEEN HOLES	MEDIDA TOTAL TOTAL MEASURE	CAIXA BOX	REFERÊNCIA REFERENCE
02	BRANCO MATE MATTE WHITE	-	40X40X12	500 UN / 50 UN	A400018003
	PRETO MATE MATTE BLACK				A400018009
	BSN BSN				A400018013

04

ACESSÓRIOS
INTERIORES
COZINHA
KITCHEN STORAGE
LAVANDARIA
LAUNDRY CARE

60 **ACESSÓRIOS INTERIORES**
- COZINHA
KITCHEN STORAGE

74 **ACESSÓRIOS INTERIORES**
- LAVANDARIA
LAUNDRY CARE

ACESSÓRIOS INTERIORES - COZINHA

KITCHEN STORAGE

CESTO GAVETA NERO

NERO DRAWER BASKET

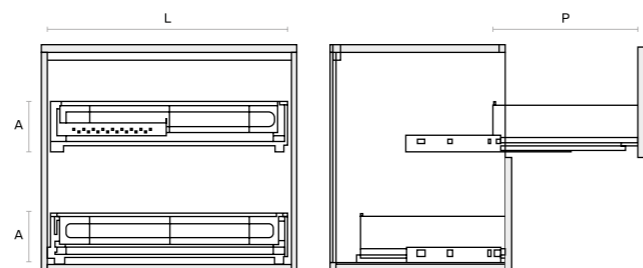

MODELO MODEL	MÓDULO CABINET	LARGURA WIDTH	ALTURA HEIGHT	PROFUNDIDADE DEPTH	CAIXA BOX	REFERÊNCIA REFERENCE
CESTO GAVETA NERO	MOD. 450	415				C300019524
	MOD. 500	465	160	460	01 UN	C300019624
	MOD. 600	565				C300019724

i COM AMORTECEDOR
SOFT CLOSE

CESTO GAVETA

DRAWER BASKET



MODELO MODEL	MÓDULO CABINET	LARGURA WIDTH	ALTURA HEIGHT	PROFUNDIDADE DEPTH	CAIXA BOX	REFERÊNCIA REFERENCE
CESTO GAVETA	MOD. 350	310				C300000105
	MOD. 400	360				C300000205
	MOD. 450	410				C300000305
	MOD. 500	460				C300000405
	MOD. 600	560	170	480	04 UN	C300000505
	MOD. 700	660				C300000605
	MOD. 800	760				C300000705
	MOD. 900	860				C300000805
	MOD. 1000	960				C300000905
	FIXADOR FRONTAL P/ CESTO GAVETA CROMADO					01 UN

i COM AMORTECEDOR
SOFT CLOSE

ACESSÓRIOS INTERIORES - COZINHA

KITCHEN STORAGE

PORTA GARRAFAS C15C

BOTTLE BASKET C15C

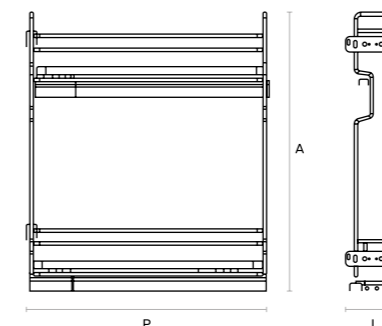

MODELO MODEL	MÓDULO CABINET	LARGURA WIDTH	ALTURA HEIGHT	PROFUNDIDADE DEPTH	CAIXA BOX	REFERÊNCIA REFERENCE
C15C	MOD. 150	120	575	470	01 UN	C300001605
SEPARADOR PORTA GARRAFAS C15C					01 UN	C300001705

i COM AMORTECEDOR
SOFT CLOSE

CESTO PARA PÃO

BREAD AND BOTTLE BASKET

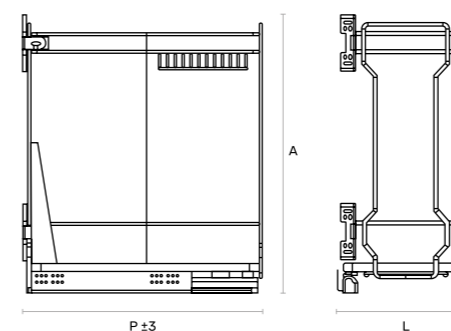

MODELO MODEL	MÓDULO CABINET	LARGURA WIDTH	ALTURA HEIGHT	PROFUNDIDADE DEPTH	CAIXA BOX	REFERÊNCIA REFERENCE
CESTO PARA PÃO	MOD. 300	250				C300001805
	MOD. 400	350	520	450	01 UN	C300001905

i COM AMORTECEDOR
SOFT CLOSE



CESTO PORTA DETERGENTES
THREE SHELVES BASKET

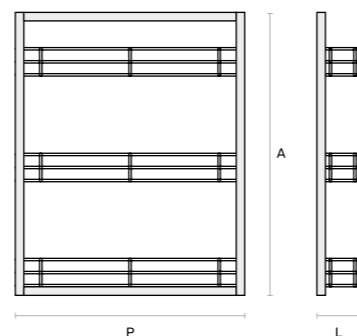

MODELO MODEL	TIPO TYPE	MÓDULO CABINET	LARGURA WIDTH	ALTURA HEIGHT	PROFUNDIDADE DEPTH	CAIXA BOX	REFERÊNCIA REFERENCE
CESTO PORTA DETERGENTES	ESQUERDO LEFT	20R	MOD. 200	170			C300001005
		30R	MOD. 300	270	600	01 UN	C300001205
		40R	MOD. 400	370			C300001405
	DIREITO RIGHT	20L	MOD. 200	170			C300001105
		30L	MOD. 300	270	600	01 UN	C300001305
		40L	MOD. 400	370			C300001505

i COM AMORTECEDOR
SOFT CLOSE



CESTO 180°
180° REVOLVING BASKET

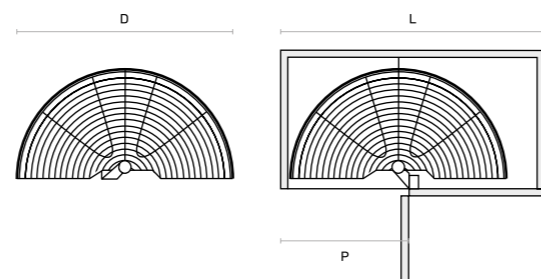

MODELO MODEL	TIPO TYPE	MÓDULO (L) CABINET (L)	PORTA (P) CABINET DOOR (P)	DIÂMETRO (D) DIAMETER (D)	CAIXA BOX	REFERÊNCIA REFERENCE
CESTO 180°	C	MOD. 750	400	680		C300002505
	A	MOD. 800	450	745	01 UN	C300002405

CESTO 180° PLÁSTICO
PLASTIC 180° REVOLVING BASKET

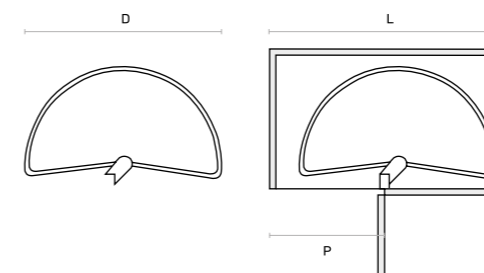

MODELO MODEL	COR COLOR	MÓDULO (L) CABINET (L)	PORTA (P) CABINET DOOR (P)	DIÂMETRO (D) DIAMETER (D)	CAIXA BOX	REFERÊNCIA REFERENCE
CESTO 180° PLÁSTICO	○ BRANCO WHITE	MOD. 900	450	750	01 UN	C300009626
	● CINZA GREY					C300009630

CESTO 270° PLÁSTICO
PLASTIC 270° REVOLVING BASKET

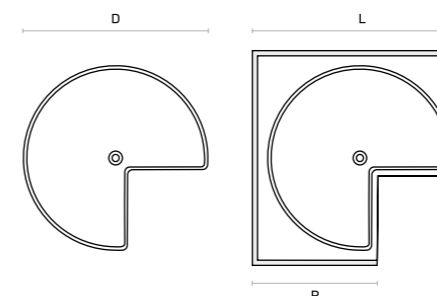

MODELO MODEL	COR COLOR	MÓDULO (L) CABINET (L)	DIÂMETRO (D) DIAMETER (D)	PROFUNDIDADE (P) DEPTH (P)	CAIXA BOX	REFERÊNCIA REFERENCE
CESTO 270° PLÁSTICO	○ BRANCO WHITE	MOD. 800	710	550	01 UN	C300009826
		MOD. 900	810	550		C300009926
	● CINZA GREY	MOD. 800	710	550		C300009830
		MOD. 900	810	550	01 UN	C300009930



CESTO 270° NERO
NERO 270° REVOLVING BASKET

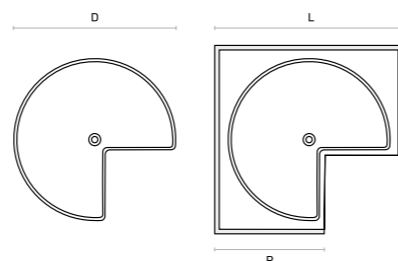

i BASE MELAMINA
MELAMINE BASE

MODELO MODEL	MÓDULO (L) CABINET (L)	DIÂMETRO (D) DIAMETER (D)	PROFUNDIDADE (P) DEPTH (P)	CAIXA BOX	REFERÊNCIA REFERENCE
CESTO 270° NERO	MOD. 800	710	565	01 UN	C300022024

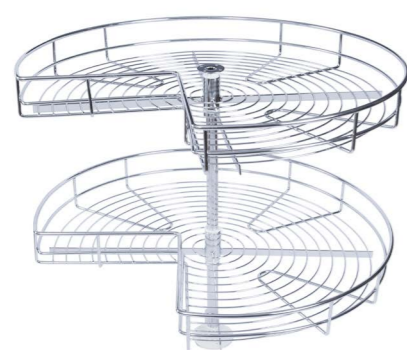

CESTO 270°
270° REVOLVING BASKET

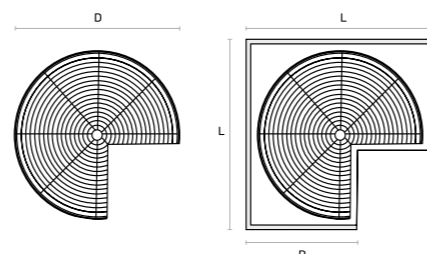

MODELO MODEL	TIPO TYPE	MÓDULO (L) CABINET (L)	DIÂMETRO (D) DIAMETER (D)	PROFUNDIDADE DEPTH	CAIXA BOX	REFERÊNCIA REFERENCE
CESTO 270°	TIPO C	MOD. 700	600			C300003005
	TIPO A	MOD. 800	710	560	01 UN	C300002805
	TIPO B	MOD. 900	800			C300002905

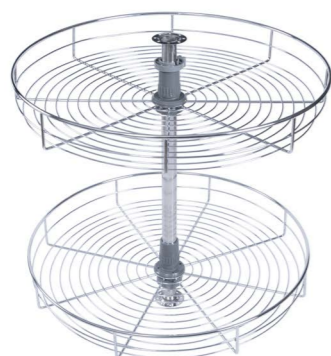

CESTO 360°
360° REVOLVING BASKET

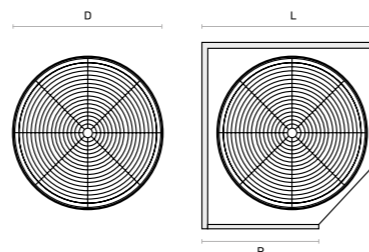

MODELO MODEL	TIPO TYPE	MÓDULO (L) CABINET (L)	DIÂMETRO (D) DIAMETER (D)	PROFUNDIDADE (P) DEPTH (P)	CAIXA BOX	REFERÊNCIA REFERENCE
CESTO 360°	F	MOD. 700	600	500		C300003305
	A	MOD. 800	710	500	01 UN	C300003105
	B	MOD. 900	820	600		C300003205

DESPENSEIRO
LARDER UNIT

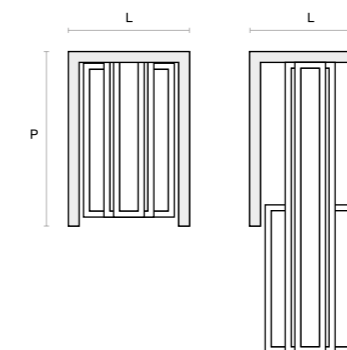

MODELO MODEL	MÓDULO CABINET	LARGURA WIDTH	ALTURA HEIGHT	PROFUNDIDADE DEPTH	PRATELEIRAS TRAYS	CAIXA BOX	REFERÊNCIA REFERENCE
DESPENSEIRO	154	MOD. 150	105				C300020005
	204	MOD. 200	155	1270/1570	505	4	01 UN C300020105
	155	MOD. 150	105				C300020205
	205	MOD. 200	155	1570/1870	505	5	01 UN C300020305
	304	MOD. 300	240				C300020405
	454	MOD. 450	395	1250/1550	505	4	01 UN C300020505
	305	MOD. 300	240				C300020605
	405	MOD. 400	345				C300020705
	455	MOD. 450	395	1550/1850	505	5	01 UN C300020805
	505	MOD. 500	445				C300020905
	306	MOD. 300	240				C300021005
	406	MOD. 400	345	1950/2250	505	6	01 UN C300021105
506	MOD. 500	445				C300021205	

i CORREDIÇA G*GRASS A PARTIR DO MOD.300
G*GRASS SLIDE FROM MOD.300

i COM AMORTECEDOR
SOFT CLOSE

CANTO FEIJÃO
SWING TRAY



CANTO FEIJÃO RETO
FLAT SWING TRAY



i COM AMORTECEDOR
SOFT CLOSE

MODELO MODEL	PORTA (P) CABINET DOOR (P)	MÓDULO (L) CABINET (L)	CAIXA BOX	REFERÊNCIA REFERENCE
CANTO FEIJÃO	ESQUERDO LEFT	400	MOD. 800	C300013330
		450	MOD. 900	C300003530
		500	MOD. 1000	C300013730
	DIREITO RIGHT	400	MOD. 800	01 UN C300013430
		450	MOD. 900	C300003630
		500	MOD. 1000	C300013830
CANTO FEIJÃO ANTRACITE	ESQUERDO LEFT	450	MOD. 900	01 UN C300003524
	DIREITO RIGHT	450	MOD. 900	C300003624
CANTO FEIJÃO RETO	ESQUERDO LEFT	400	MOD. 800	C300011824
		450	MOD. 900	C300012024
		500	MOD. 1000	01 UN C300012224
	DIREITO RIGHT	400	MOD. 800	C300011924
		450	MOD. 900	C300012124
		500	MOD. 1000	C300012324

CESTO MÁGICO
REVERSIBLE CORNER MECHANISM

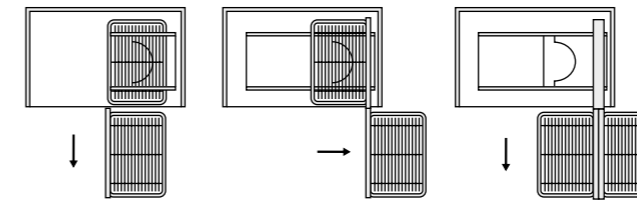

MODELO MODEL	MÓDULO (L) CABINET (L)	PORTA (P) CABINET DOOR (P)	MEDIDAS MEASURES	CAIXA BOX	REFERÊNCIA REFERENCE
CESTO MÁGICO	MOD. 900	450	A590 X L600 X P485	01 UN	C300004105

CANTO MÁGICO
MAGIC CORNER

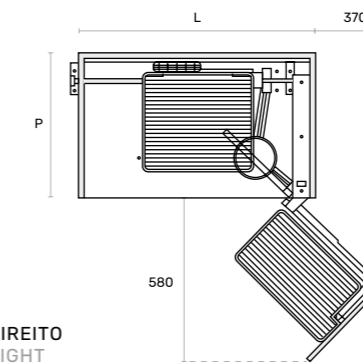

MODELO MODEL	MÓDULO (L) CABINET (L)	PORTA (P) CABINET DOOR (P)	MEDIDAS MEASURES	CAIXA BOX	REFERÊNCIA REFERENCE	
CANTO MÁGICO	ESQUERDO LEFT	MOD. 900	450	A620 X L860 X P500	01 UN C300003705	
		DIREITO RIGHT	MOD. 900			450
	IN	ESQUERDO LEFT	MOD. 900	450	A520 X L860 X P500	01 UN C300003905
		DIREITO RIGHT	MOD. 900	450		

i MODELO IN COM CORREDIÇA G*GRASS
MODEL IN WITH G*GRASS SLIDE

i COM AMORTECEDOR
SOFT CLOSE



CESTO MÁGICO NERO
NERO REVERSIBLE CORNER MECHANISM

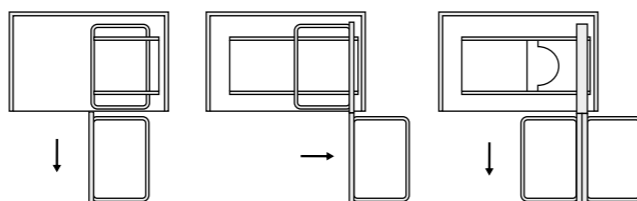

MODELO MODEL	MÓDULO CABINET	PORTA (P) CABINET DOOR (P)	MEDIDAS MEASURES	CAIXA BOX	REFERÊNCIA REFERENCE
CESTO MÁGICO NERO	MOD. 900	450	A516 X L860 X P500	01 UN	C300019024

i BASE MELAMINA
MELAMINE BASE



LEMANS II
LEMANS II

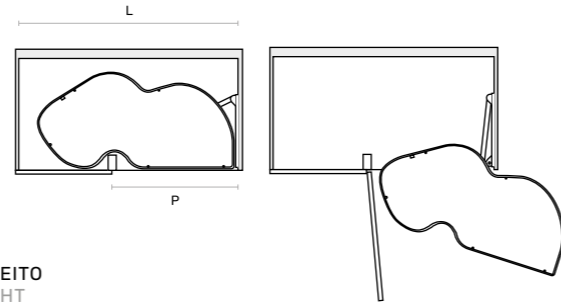

DIREITO
RIGHT

MODELO MODEL	PORTA (P) CABINET DOOR (P)	MÓDULO (L) CABINET (L)	CAIXA BOX	REFERÊNCIA REFERENCE
LEMANS II	400	MOD. 800	01 UN	C300008622
	450	MOD. 900		C300008822
	500	MOD. 1000		C300009022
	600	MOD. 1000		C300009222
ESQUERDO LEFT	400	MOD. 800	01 UN	C300008722
	450	MOD. 900		C300008922
	500	MOD. 1000		C300009122
	600	MOD. 1000		C300009322



CLEANING AGENT
CLEANING AGENT



CLEANING AGENT
**CONSULTE TODA A INFORMAÇÃO
TÉCNICA NA PÁG. 154 E 155**
P.154 AND 155 FOR MORE
TECHNICAL INFORMATION

MODELO MODEL	MÓDULO (L) CABINET (L)	MEDIDAS MEASURES	CAIXA BOX	REFERÊNCIA REFERENCE
CLEANING AGENT	MOD. 300	A480 X L298 X P480	01 UN	C300009424

PORTA GARRAFAS QUADRO
QUADRO BOTTLE BASKET

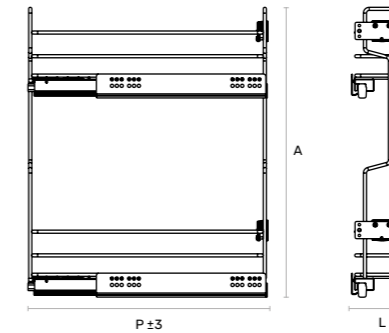

MODELO MODEL	MÓDULO CABINET	LARGURA WIDTH	ALTURA HEIGHT	PROFUNDIDADE DEPTH	CAIXA BOX	REFERÊNCIA REFERENCE
PORTA GARRAFAS QUADRO	MOD. 150	108	539	469	01 UN	C300007805
	MOD. 200	158	539	446		C300007905
SEPARADOR PORTA GARRAFAS CINZA					01 UN	C300006830

i CORREDIÇAS SALICE EXTRAÇÃO PARCIAL 30KG
EQUIPPED WITH SALICE SLIDES, LOAD CAPACITY 30KG

PORTA GARRAFAS QUADRO
QUADRO BOTTLE BASKET

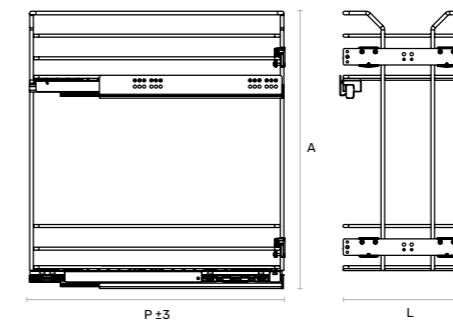

MODELO MODEL	MÓDULO CABINET	LARGURA WIDTH	ALTURA HEIGHT	PROFUNDIDADE DEPTH	CAIXA BOX	REFERÊNCIA REFERENCE
PORTA GARRAFAS QUADRO	MOD. 300	264	539	469	01 UN	C300008005
	MOD. 400	364	539	469		C300008105

i CORREDIÇAS CRUZADAS SALICE EXTRAÇÃO PARCIAL 30KG
STAGGERED SALICE SLIDES, LOAD CAPACITY 30KG



PORTA GARRAFAS GOLD
GOLD BOTTLE BASKET

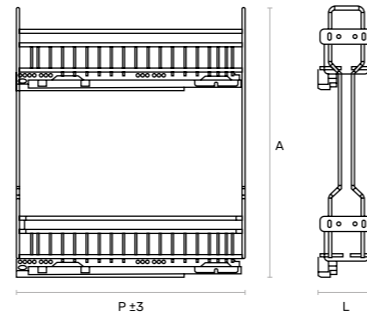

MODELO MODEL	MÓDULO CABINET	LARGURA WIDTH	ALTURA HEIGHT	PROFUNDIDADE DEPTH	CAIXA BOX	REFERÊNCIA REFERENCE
PORTA GARRAFAS GOLD	MOD. 150	108	539	496	01 UN	C300006905
	MOD. 200	158	539	466		C300007005
	MOD. 250	208	539	496		C300007105
SEPARADOR PORTA GARRAFAS CINZA					01 UN	C300006830

i CORREDIÇAS HETTICH EXTRAÇÃO TOTAL 30KG
EQUIPPED WITH HETTICH SLIDES, LOAD CAPACITY 30KG

CANTO MÁGICO GOLD
GOLD MAGIC CORNER

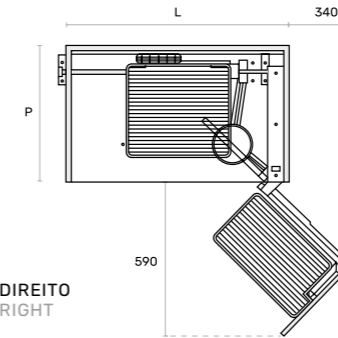

MODELO MODEL	MÓDULO (L) CABINET (L)	PORTA (P) CABINET DOOR (P)	MEDIDAS MEASURES	CAIXA BOX	REFERÊNCIA REFERENCE
CANTO MÁGICO GOLD	ESQUERDO LEFT	MOD. 900	450	A640 X L860 X P485	01 UN
	DIREITO RIGHT	MOD. 900	450		
					C300008405

PORTA GARRAFAS DELUXE
DELUXE BOTTLE BASKET

PORTA GARRAFAS DELUXE
DELUXE BOTTLE BASKET



PORTA GARRAFAS GOLD
GOLD BOTTLE BASKET

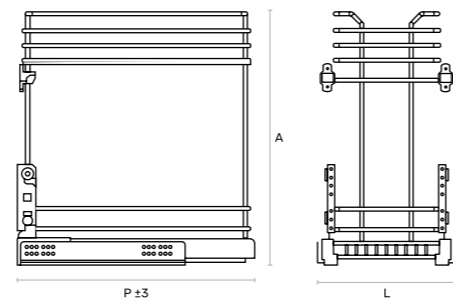

MODELO MODEL	MÓDULO CABINET	LARGURA WIDTH	ALTURA HEIGHT	PROFUNDIDADE DEPTH	CAIXA BOX	REFERÊNCIA REFERENCE
PORTA GARRAFAS GOLD	MOD. 300	264	539	496	01 UN	C300007205
	MOD. 350	314				C300007305
	MOD. 400	364				C300007405
	MOD. 450	414				C300007505
	MOD. 500	464				C300007605
	MOD. 600	564				-

i CORREDIÇAS HETTICH EXTRAÇÃO TOTAL 30KG
EQUIPPED WITH HETTICH SLIDES, LOAD CAPACITY 30KG

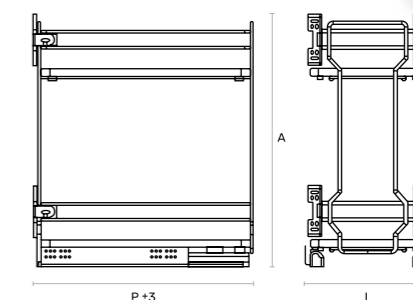
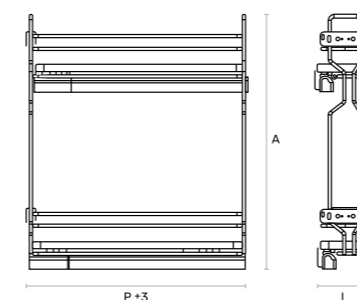
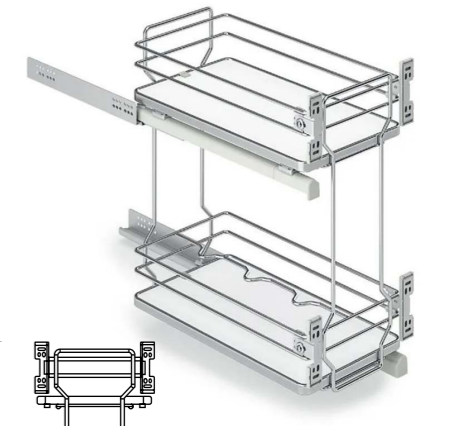
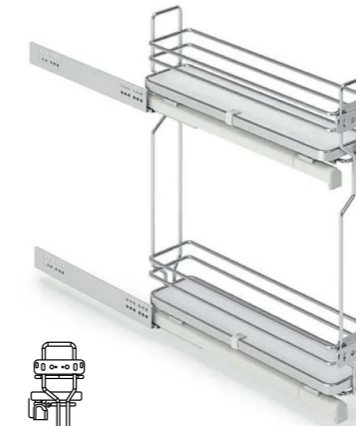

MODELO MODEL	MÓDULO CABINET	LARGURA WIDTH	ALTURA HEIGHT	PROFUNDIDADE DEPTH	CAIXA BOX	REFERÊNCIA REFERENCE
PORTA GARRAFAS DELUXE	MOD. 150	110	533	510	01 UN	C300010622
	MOD. 200	160	533	510		C300010722
PORTA GARRAFAS DELUXE	MOD. 250	213	544	510	01 UN	C300010822
	MOD. 300	263	544	510		C300010922

i CORREDIÇAS HETTICH EXTRAÇÃO TOTAL 30KG
EQUIPPED WITH HETTICH SLIDES, LOAD CAPACITY 30KG

i MELAMINA CINZA
GRAY MELAMINE

PORTA GARRAFAS HYPER
HYPER BOTTLE BASKET

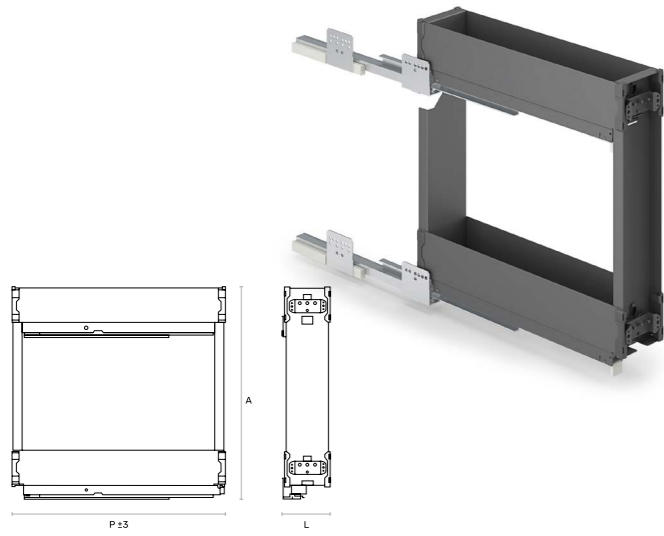

MODELO MODEL	MÓDULO CABINET	LARGURA WIDTH	ALTURA HEIGHT	PROFUNDIDADE DEPTH	CAIXA BOX	REFERÊNCIA REFERENCE
PORTA GARRAFAS HYPER	MOD. 150	109	507	485	01 UN	C300016024
	MOD. 200	159	507	485		C300016124

i CORREDIÇAS G*GRASS EXTRAÇÃO TOTAL 40KG
EQUIPPED WITH G*GRASS SLIDES, LOAD CAPACITY 40KG

PORTA GARRAFAS HYPER	MOD. 300	264	507	485	01 UN	C300016224
	MOD. 400	364	507	485		C300016324
	MOD. 450	414	507	485		C300016424
	MOD. 500	464	507	485		C300016524
	MOD. 600	564	507	485		C300016624

i CORREDIÇAS CRUZADAS G*GRASS EXTRAÇÃO TOTAL 40KG
STAGGERED G*GRASS SLIDES, LOAD CAPACITY 40KG

PORTA GARRAFAS HYPER
HYPER BOTTLE BASKET

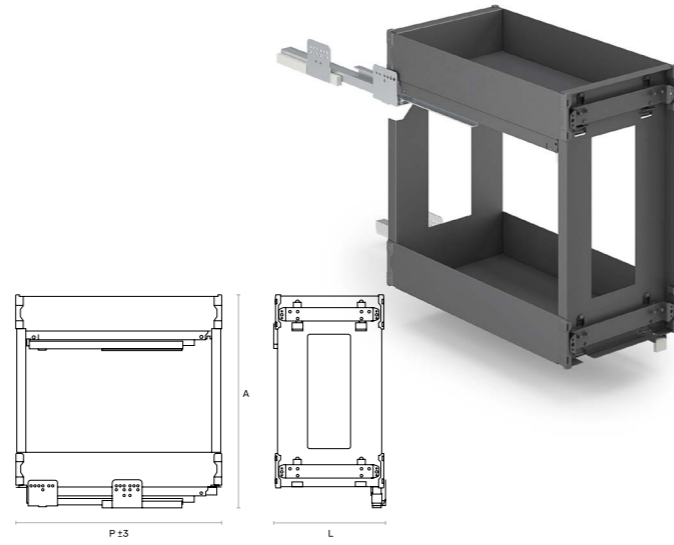

CANTO MÁGICO DYNAMIC
DYNAMIC MAGIC CORNER

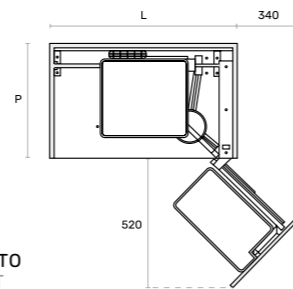

MODELO MODEL	MÓDULO CABINET	PORTA (P) CABINET DOOR (P)	MEDIDAS MEASURES	CAIXA BOX	REFERÊNCIA REFERENCE	
CANTO MÁGICO DYNAMIC	ESQUERDO LEFT	MOD. 900	450	A640 X L860 X P485	01 UN	C300017724
	DIREITO RIGHT	MOD. 900	450			C300017824

CANTO COMBI
COMBI SWING TRAY

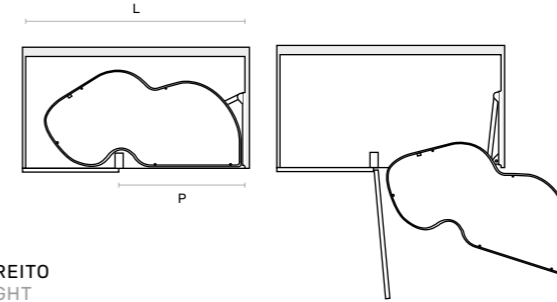

MODELO MODEL	PORTA (P) CABINET DOOR (P)	MÓDULO (L) CABINET (L)	CAIXA BOX	REFERÊNCIA REFERENCE	
CANTO COMBI	ESQUERDO LEFT	450	MOD. 900	01 UN	C300017024
		500	MOD. 1000		C300017224
		600	MOD. 1200		C300017424
	DIREITO RIGHT	450	MOD. 900	01 UN	C300017124
		500	MOD. 1000		C300017324
		600	MOD. 1200		C300017524
INOXA - COMBI SOFT CLOSE HYPER			01 UN	C300017624	

CESTO GAVETA HYPER
HYPER PULL OUT BASKET

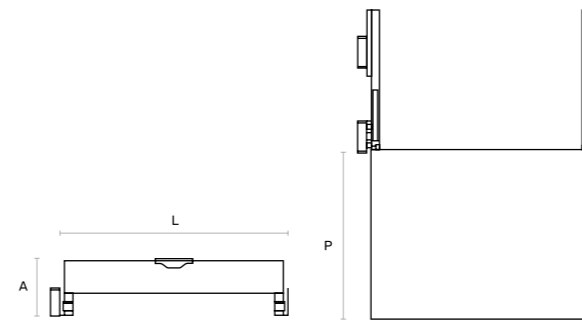

MODELO MODEL	MÓDULO CABINET	LARGURA WIDTH	ALTURA HEIGHT	PROFUNDIDADE DEPTH	CAIXA BOX	REFERÊNCIA REFERENCE
CESTO GAVETA HYPER	MOD. 400	363	132	453	01 UN	C300015224
	MOD. 450	413	132	453		C300015324
	MOD. 500	463	132	453		C300015424
	MOD. 600	563	132	453		C300015524

i CORREDIÇAS G*GRASS EXTRAÇÃO TOTAL 40KG
EQUIPPED WITH G*GRASS SLIDES, LOAD CAPACITY 40KG



TULHA QUADRO
QUADRO LAUNDRY BASKET

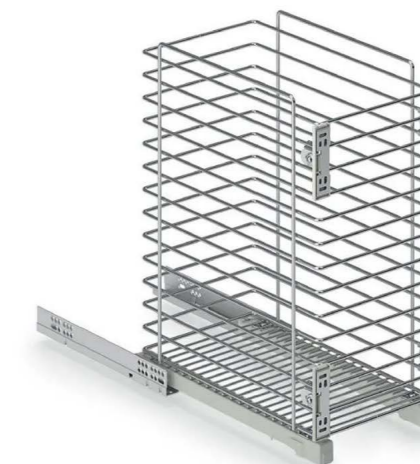
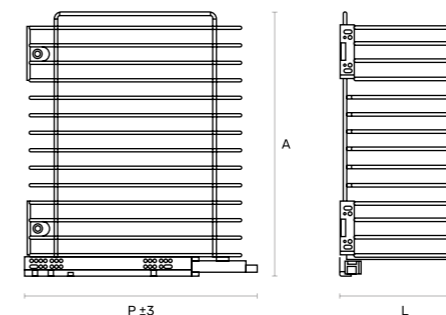

MODELO MODEL	MÓDULO CABINET	LARGURA WIDTH	ALTURA HEIGHT	PROFUNDIDADE DEPTH	CAIXA BOX	REFERÊNCIA REFERENCE
TULHA QUADRO	MOD. 300	264	542	475	01 UN	C300012505
	MOD. 400	364	542	475		C300012605
	MOD. 450	414	542	475		C300012705
	MOD. 500	464	542	475		C300013005
	MOD. 600	564	542	475		C300012805

TULHA A
A LAUNDRY BASKET

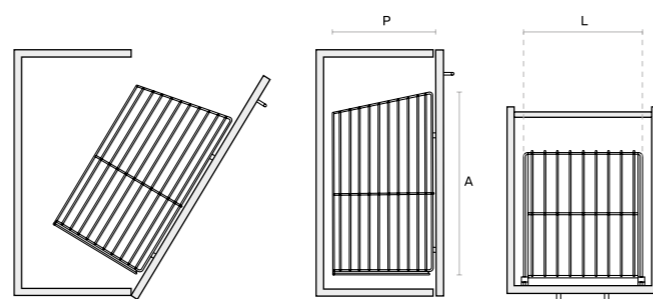

MODELO MODEL	MÓDULO CABINET	LARGURA WIDTH	ALTURA HEIGHT	PROFUNDIDADE DEPTH	CAIXA BOX	REFERÊNCIA REFERENCE
TULHA A	MOD. 300	230	500	250	01 UN	C300004405
	MOD. 350	280	500	250		C300004505
	MOD. 400	330	500	250		C300004605
	MOD. 450	380	500	250		C300004705
	MOD. 500	430	500	250		C300004805
COMPASSO P/TULHA CROMADA A					01 UN	C300004905

TULHA 3270
3270 LAUNDRY BASKET

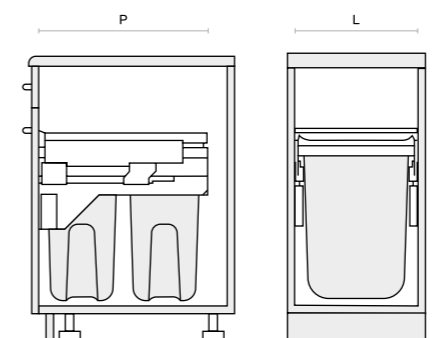

MODELO MODEL	MÓDULO CABINET	CAPACIDADE CAPACITY	LARGURA WIDTH	ALTURA HEIGHT	PROFUNDIDADE DEPTH	CAIXA BOX	REFERÊNCIA REFERENCE
327046	MOD. 450	2X33L	412-418	545	528	01 UN	B610327045
327050	MOD. 500	2X33L	462-468	545	528		B610327050
327060	MOD. 600	2X33L	562-568	545	403-448		B610327060

05

BALDES DO LIXO WASTE BINS

78 EXTRAÇÃO FRONTAL
PULL OUT SYSTEM

120 FIXAÇÃO PORTA
DOOR FRONT FIXING

124 GIRATÓRIOS PARA PORTA
SWING OUT

126 GAVETÃO
UNDER DRAWER

131 ENCASTRAR
WORKTOP BIN

EXTRAÇÃO FRONTAL

PULL OUT SYSTEM

EXTRAÇÃO FRONTAL

PULL OUT SYSTEM

ALADIN

ALADIN

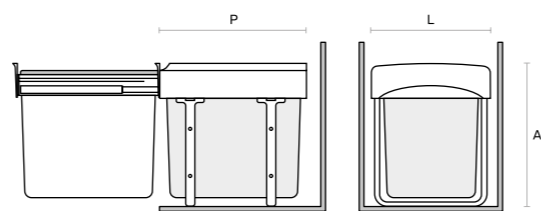

MODELO MODEL	MÓDULO CABINET	BALDES BUCKETS	CAPACIDADE CAPACITY	MEDIDAS MEASURES	CAIXA BOX	REFERÊNCIA REFERENCE
9013	MOD. 300		1X16L	P (MIN333 - MAX685) X L287 X A362	01 UN	B600229013
9014			2X8L			B600229014

SOLO

SOLO

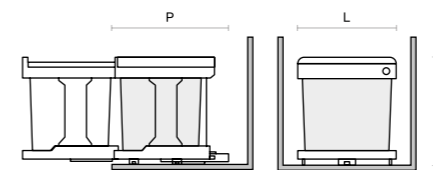

MODELO MODEL	MÓDULO CABINET	BALDES BUCKETS	CAPACIDADE CAPACITY	MEDIDAS MEASURES	CAIXA BOX	REFERÊNCIA REFERENCE
363600	MOD. 300		1X20L	P427 X L245 X A396	01 UN	B600363410

ECOFIL

ECOFIL

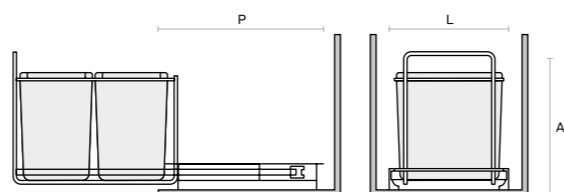

MODELO MODEL	MÓDULO CABINET	BALDES BUCKETS	CAPACIDADE CAPACITY	MEDIDAS MEASURES	CAIXA BOX	REFERÊNCIA REFERENCE
34A2	MOD. 300		2X12L	P450 X L230 X A340	01 UN	B6000034A2

230

230

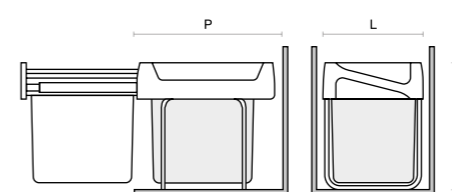

MODELO MODEL	MÓDULO CABINET	BALDES BUCKETS	CAPACIDADE CAPACITY	MEDIDAS MEASURES	CAIXA BOX	REFERÊNCIA REFERENCE
230	MOD. 300		1X20L	P439 X L246 X A388	01 UN	B60000230

TANDEM

TANDEM

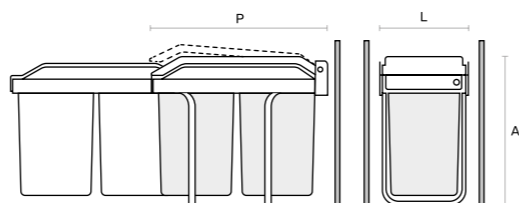

MODELO MODEL	MÓDULO CABINET	BALDES BUCKETS	CAPACIDADE CAPACITY	MEDIDAS MEASURES	CAIXA BOX	REFERÊNCIA REFERENCE
365010	MOD. 300		2X15L	P505 X L252 X A455	01 UN	B600365010

231

231

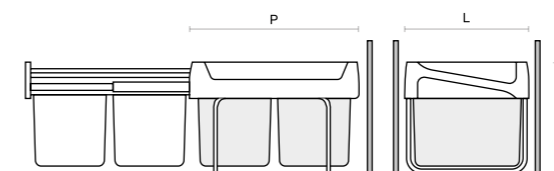

MODELO MODEL	MÓDULO CABINET	BALDES BUCKETS	CAPACIDADE CAPACITY	MEDIDAS MEASURES	CAIXA BOX	REFERÊNCIA REFERENCE
231	MOD. 400		2X15L	P469 X L342 X A304	01 UN	B60000231

EXTRAÇÃO FRONTAL PULL OUT SYSTEM



EKKO 40
EKKO 40

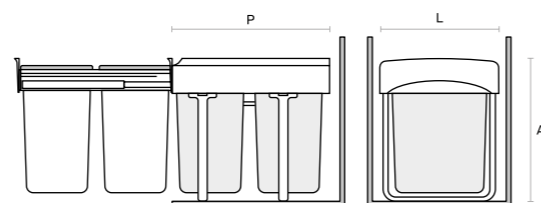

MODELO MODEL	MÓDULO CABINET	BALDES BUCKETS	CAPACIDADE CAPACITY	MEDIDAS MEASURES	CAIXA BOX	REFERÊNCIA REFERENCE
9000			1X34L			B600229000
9004	MOD. 400		2X16L	P (MIN473 - MAX910) X L355 X A365	01 UN	B600229004
9005			1X16L + 2X8L			B600229005
9006			4X8L			B600229006



MEGA 40
MEGA 40

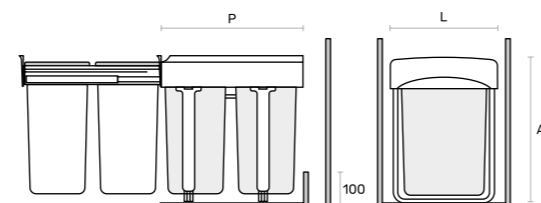

MODELO MODEL	MÓDULO CABINET	BALDES BUCKETS	CAPACIDADE CAPACITY	MEDIDAS MEASURES	CAIXA BOX	REFERÊNCIA REFERENCE
9008	MOD. 400		2X20L	P (MIN480 - MAX910) X L356 X A483	01 UN	B600009008

CORREDIÇA COM AMORTECEDOR
SOFT CLOSE SLIDE



TANK 40
TANK 40

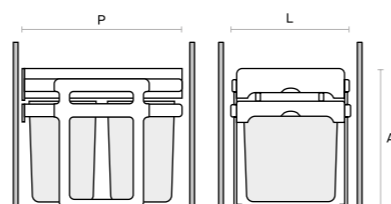

MODELO MODEL	MÓDULO CABINET	BALDES BUCKETS	CAPACIDADE CAPACITY	MEDIDAS MEASURES	CAIXA BOX	REFERÊNCIA REFERENCE
9093	MOD. 400		2X16L	P (MIN486 - MAX985) X L339 X A428	01 UN	B600009093

EXTRAÇÃO FRONTAL PULL OUT SYSTEM

ECOFIL
ECOFIL

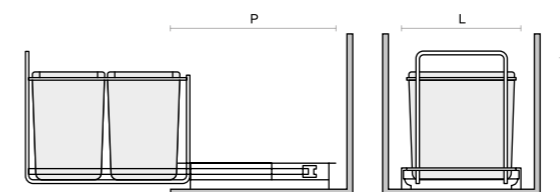

MODELO MODEL	MÓDULO CABINET	BALDES BUCKETS	CAPACIDADE CAPACITY	MEDIDAS MEASURES	CAIXA BOX	REFERÊNCIA REFERENCE
34B2	MOD. 400		2X18L	P450 X L300 X A340	01 UN	B6000034B2

TOWER 609
TOWER 609

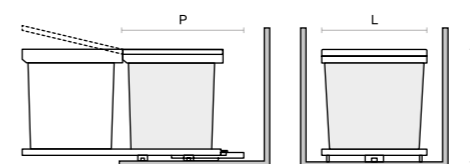

MODELO MODEL	MÓDULO CABINET	BALDES BUCKETS	CAPACIDADE CAPACITY	MEDIDAS MEASURES	CAIXA BOX	REFERÊNCIA REFERENCE
TOWER 609	MOD. 400		2X17L	P410 X L250 X A395	01 UN	B600006091

AS RAUMSPAR TANDEM
AS RAUMSPAR TANDEM

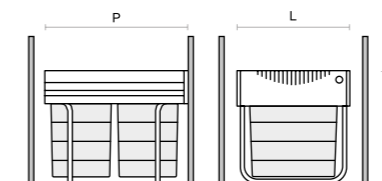

MODELO MODEL	MÓDULO CABINET	BALDES BUCKETS	CAPACIDADE CAPACITY	MEDIDAS MEASURES	CAIXA BOX	REFERÊNCIA REFERENCE
364112	MOD. 400		2X18L	P475 X L346 X A336	01 UN	B600364112

EXTRAÇÃO FRONTAL PULL OUT SYSTEM



AS RAUMSPAR TANDEM COMFORT AS RAUMSPAR TANDEM COMFORT

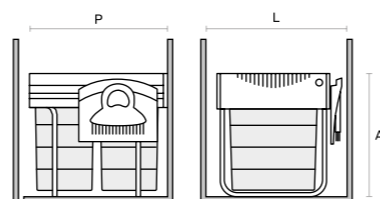

MODELO MODEL	MÓDULO CABINET	BALDES BUCKETS	CAPACIDADE CAPACITY	MEDIDAS MEASURES	CAIXA BOX	REFERÊNCIA REFERENCE
364122	MOD. 400		2X20L	P475 X L346 X A392	01 UN	B600364122



EASY CARGO EASY CARGO

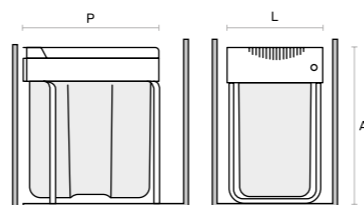

MODELO MODEL	MÓDULO CABINET	BALDES BUCKETS	CAPACIDADE CAPACITY	MEDIDAS MEASURES	CAIXA BOX	REFERÊNCIA REFERENCE
366840	MOD. 400		1X42L	P466 X L320 X A542	01 UN	B600366840



FREE JAZZ FREE JAZZ



MODELO MODEL	MÓDULO CABINET	BALDES BUCKETS	CAPACIDADE CAPACITY	MEDIDAS MEASURES	CAIXA BOX	REFERÊNCIA REFERENCE
12452	MOD. 450		3X7L + 1X15L	P469 X L406 X A335	01 UN	B600412452
12454			3X7L + 1X26L	P469 X L406 X A545		B600412454
12602	MOD. 600		1X7L + 3X15L	P469 X L555 X A335		B600412602
12605			1X7L + 3X26L	P469 X L555 X A545		B600412605

FIXAÇÃO NA PORTA DOOR FRONT FIXING

BLOCK 2.0 BLOCK 2.0

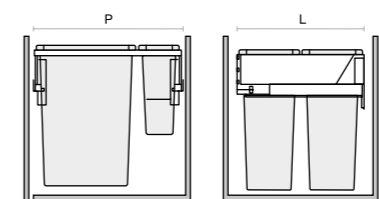

MODELO MODEL	MÓDULO CABINET	BALDES BUCKETS	CAPACIDADE CAPACITY	MEDIDAS MEASURES	CAIXA BOX	REFERÊNCIA REFERENCE
A4730	MOD. 300		1X35L	P478 X L263 X A535	01 UN	B060A4730A
A4740	MOD. 400		1X35L	P478 X L363 X A535		B060A4740A
A4745	MOD. 450		2X35L	P478 X L413 X A535		B060A4745A
A4750	MOD. 500		2X35L	P478 X L463 X A535		B060A4750A
A4760	MOD. 600		2X35L + 2X8L	P478 X L563 X A535		B060A4760A

SINK BLOCK 2.0 SINK BLOCK 2.0

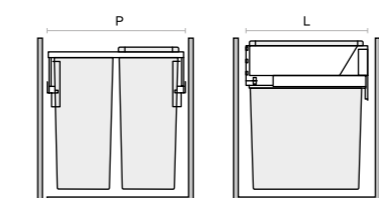

B3560 - COM PEGA
B3560 - WITH HANDLE

MODELO MODEL	MÓDULO CABINET	BALDES BUCKETS	CAPACIDADE CAPACITY	MEDIDAS MEASURES	CAIXA BOX	REFERÊNCIA REFERENCE
A3550	MOD. 500		1X18L + 1X12L	P358 X L463 X A358	01 UN	B060A3550A
A3560	MOD. 600		2X18L	P358 X L563 X A358		B060A3560A
B3560			2X12L + 1X18L			B060B3560B
COBERTURA BLOCK 2.0	MOD. 500	-	-	P350 X L500	01 UN	B0600C3550
	MOD. 600	-	-	P350 X L600		B0600C3560

FIXAÇÃO NA PORTA DOOR FRONT FIXING



EKKO FRONT 40

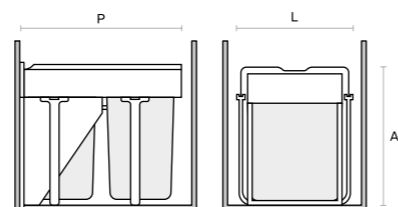

MODELO MODEL	MÓDULO CABINET	BALDES BUCKETS	CAPACIDADE CAPACITY	MEDIDAS MEASURES	CAIXA BOX	REFERÊNCIA REFERENCE
9073			1X34L			B600009073
9022	MOD. 400		2X16L	P (MIN466 - MAX900) X L355 X A365	01 UN	B600009022
9023			1X16L + 2X8L			B600009023



TANK FRONT 40

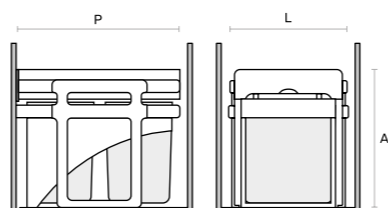

MODELO MODEL	MÓDULO CABINET	BALDES BUCKETS	CAPACIDADE CAPACITY	MEDIDAS MEASURES	CAIXA BOX	REFERÊNCIA REFERENCE
9146	MOD. 400		2X16L	P (MIN486 - MAX985) X L339 X A428	01 UN	B600009146



UNIKA 60

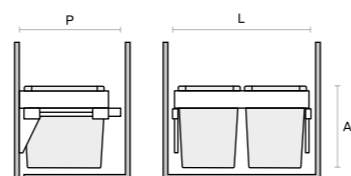

COM CORREDIÇA 450MM
WITH SLIDE 450MM

MODELO MODEL	MÓDULO CABINET	BALDES BUCKETS	CAPACIDADE CAPACITY	MEDIDAS MEASURES	CAIXA BOX	REFERÊNCIA REFERENCE
9156	MOD. 600		2X15L	P (MIN330 - MAX450) X L568 X A335	01 UN	B600009156

FIXAÇÃO NA PORTA DOOR FRONT FIXING

FRONT FRONT

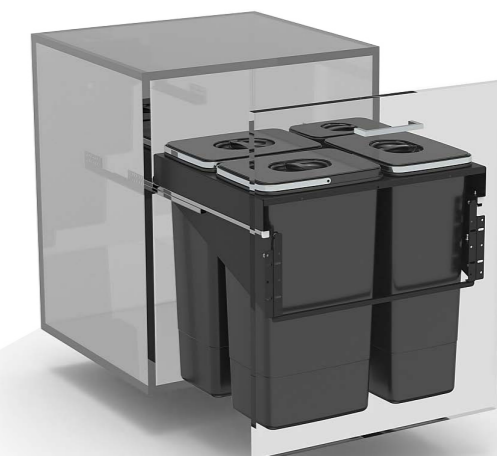
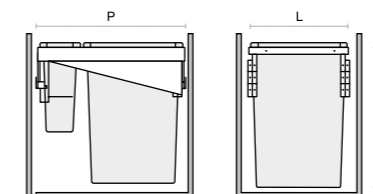

MODELO MODEL	MÓDULO CABINET	BALDES BUCKETS	CAPACIDADE CAPACITY	MEDIDAS MEASURES	CAIXA BOX	REFERÊNCIA REFERENCE
FRONT 300	MOD. 300		1X26L + 1X7L	P480 X L260 X A530		B600141601
FRONT 400	MOD. 400		2X26L	P480 X L360 X A530		B600141602
FRONT 450	MOD. 500		2X26L	P480 X L410 X A530	01 UN	B600141604
FRONT 600	MOD. 600		1X7L + 3X26L	P480 X L600 X A530		B600141606

AS EURO CARGO AS EURO CARGO

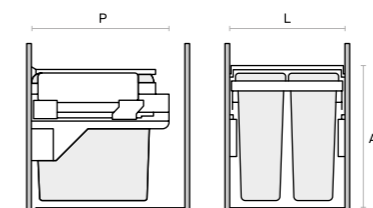

MODELO MODEL	MÓDULO CABINET	BALDES BUCKETS	CAPACIDADE CAPACITY	MEDIDAS MEASURES	CAIXA BOX	REFERÊNCIA REFERENCE
361047	MOD. 450		2X19L	P448 X L412-418 X A439		B600361047
361052	MOD. 500		1X30L + 1X19L	P448 X L462-468 X A439		B600361052
361062			2X30L	P448 X L562-568 X A439	01 UN	B600361062
361084	MOD. 600		2X28L	P448 X L562-568 X A370		B600361084

GIRATÓRIOS PARA PORTA

SWING OUT



PEPE 40
PEPE 40

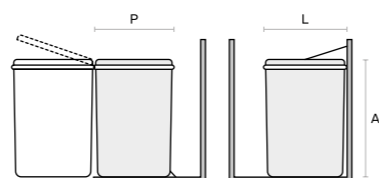

MODELO MODEL	MÓDULO CABINET	BALDES BUCKETS	CAPACIDADE CAPACITY	MEDIDAS MEASURES	CAIXA BOX	REFERÊNCIA REFERENCE
9101	MOD. 400		1X13L	P245 X L235 X A362	01 UN	B600009101



SESAMO 45
SESAMO 45

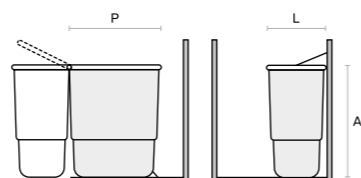

MODELO MODEL	MÓDULO CABINET	BALDES BUCKETS	CAPACIDADE CAPACITY	MEDIDAS MEASURES	CAIXA BOX	REFERÊNCIA REFERENCE
9011	MOD. 400		1X16L	P237 X L312 X A340	01 UN	B600009011



RING
RING

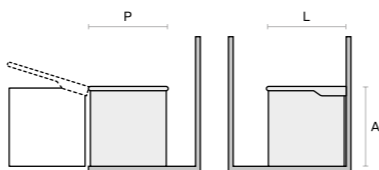

MODELO MODEL	MÓDULO CABINET	BALDES BUCKETS	CAPACIDADE CAPACITY	MEDIDAS MEASURES	CAIXA BOX	REFERÊNCIA REFERENCE
602	MOD. 400		1X10L	P265 X L265 X A320	01 UN	B600006021
607						B600006071

i MODELO 602 - PLÁSTICO | MODELO 607 - INOX
MODEL 602 - PLASTIC | MODEL 607 - STAINLESS STEEL

GIRATÓRIOS PARA PORTA

SWING OUT

BIG BOX
BIG BOX

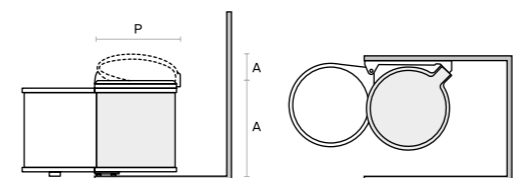

MODELO MODEL	MÓDULO CABINET	BALDES BUCKETS	CAPACIDADE CAPACITY	MEDIDAS MEASURES	CAIXA BOX	REFERÊNCIA REFERENCE
371590	MOD. 400		1X15L	P306 X L306 X A335-420	01 UN	B600371590
371521						B600371521
371519						B600371519
371510						B600371510

MONO
MONO

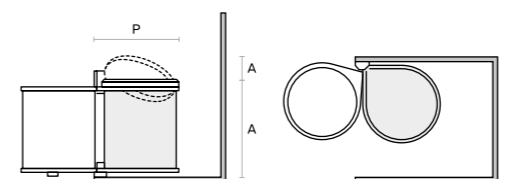

MODELO MODEL	MÓDULO CABINET	BALDES BUCKETS	CAPACIDADE CAPACITY	MEDIDAS MEASURES	CAIXA BOX	REFERÊNCIA REFERENCE
351501	MOD. 400		1X15L	P304 X L290 X A365-455	01 UN	B600351501



GAVETÃO

UNDER DRAWER



SEPARATO K

SEPARATO K

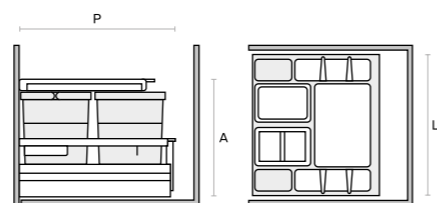

MODELO MODEL	MÓDULO CABINET	BALDES BUCKETS	CAPACIDADE CAPACITY	MEDIDAS MEASURES	CAIXA BOX	REFERÊNCIA REFERENCE
362061	MOD. 600		1X18L + 2X8L	P491 X L557 X A340	01 UN	B600362061
362090	MOD. 900		2X18L + 2X8L	P491 X L860 X A340		B600362090

PRACTIKO 600

PRACTIKO 600

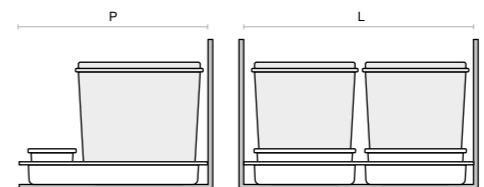

MODELO MODEL	MÓDULO CABINET	BALDES BUCKETS	CAPACIDADE CAPACITY	MEDIDAS MEASURES	CAIXA BOX	REFERÊNCIA REFERENCE
9108	MOD. 600		2X12L + 2 DISHES	P473 X L510 X A230	01 UN	B600009108
9109	MOD. 600		1X12L + 2X5L + 2 DISHES	P473 X L510 X A230	01 UN	B600009109
9110	MOD. 600		2X15L + 2 DISHES	P473 X L510 X A300	01 UN	B600009110



JAZZ

JAZZ

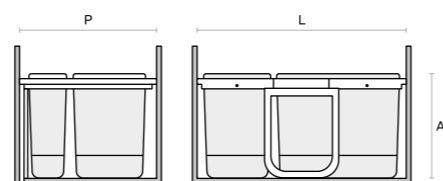

MODELO MODEL	MÓDULO CABINET	BALDES BUCKETS	CAPACIDADE CAPACITY	MEDIDAS MEASURES	CAIXA BOX	REFERÊNCIA REFERENCE
42451	MOD. 450		1X15L + 3X7L	P461 X L391 X A300	01 UN	B600242451
42602	MOD. 600		3X12L + 1X5L	P461 X L540 X A230		B600242602
42601			3X15L + 1X7L	P461 X L540 X A300		B600242601
42902	MOD. 900		5X12L + 1X5L	P461 X L845 X A230	B600242902	
42901			5X15L + 1X7L	P461 X L845 X A300	B600242901	

PRACTIKO 800

PRACTIKO 800



MODELO MODEL	MÓDULO CABINET	BALDES BUCKETS	CAPACIDADE CAPACITY	MEDIDAS MEASURES	CAIXA BOX	REFERÊNCIA REFERENCE
9161	MOD. 800		3X12L	P473 X L710 X A230	01 UN	B600009161
9163	MOD. 800		3X15L	P473 X L710 X A300	01 UN	B600009163
9164	MOD. 800		2X15L + 2X7L	P473 X L710 X A300	01 UN	B600009164

GAVETÃO

UNDER DRAWER

PRACTIKO 900

PRACTIKO 900

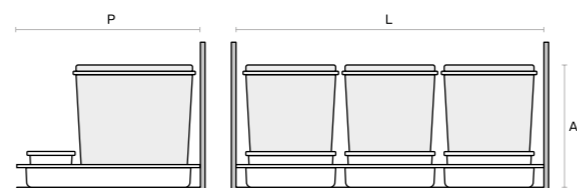

MODELO MODEL	MÓDULO CABINET	BALDES BUCKETS	CAPACIDADE CAPACITY	MEDIDAS MEASURES	CAIXA BOX	REFERÊNCIA REFERENCE
9114	MOD. 900		3X12L + 3 DISHES	P473 X L810 X A230	01 UN	B600009114
9116	MOD. 900		3X15L + 3 DISHES	P473 X L810 X A300	01 UN	B600009116
9117	MOD. 900		2X15L + 2X7L + 3 DISHES	P473 X L810 X A300	01 UN	B600009117

PRACTIKO 1200

PRACTIKO 1200

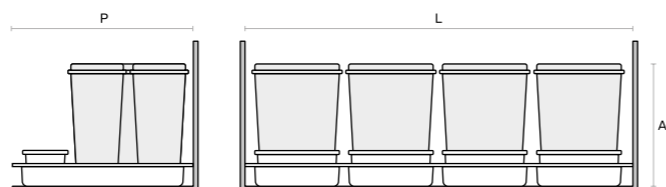

MODELO MODEL	MÓDULO CABINET	BALDES BUCKETS	CAPACIDADE CAPACITY	MEDIDAS MEASURES	CAIXA BOX	REFERÊNCIA REFERENCE
9120	MOD. 1200		4X12L + 4 DISHES	P473 X L1110 X A230	01 UN	B600009120
9122	MOD. 1200		4X15L + 4 DISHES	P473 X L1110 X A300	01 UN	B600009122
9123	MOD. 1200		3X15L + 2X7L + 4 DISHES	P473 X L1110 X A300	01 UN	B600009123

GAVETÃO

UNDER DRAWER

METROPOLIS

METROPOLIS

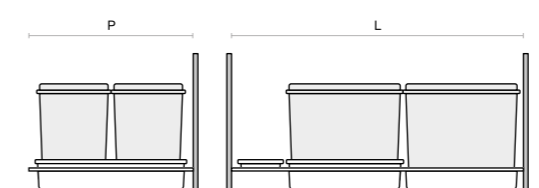

MODELO MODEL	MÓDULO CABINET	BALDES BUCKETS	CAPACIDADE CAPACITY	MEDIDAS MEASURES	CAIXA BOX	REFERÊNCIA REFERENCE
75022	MOD. 750		3X12L	P490 X L650 X A220	01 UN	B600075022
100022	MOD. 1000		3X12L	P490 X L930 X A220	01 UN	B600100022
100028	MOD. 1000		3X16L	P490 X L930 X A280	01 UN	B600100028

ENCASTRAR

WORKTOP BIN

516

516

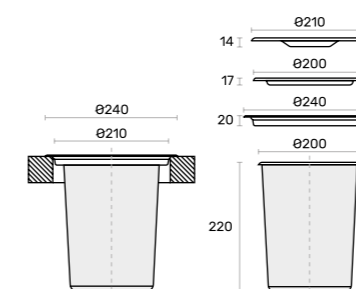

MODELO MODEL	MÓDULO CABINET	BALDES BUCKETS	CAPACIDADE CAPACITY	MEDIDAS MEASURES	CAIXA BOX	REFERÊNCIA REFERENCE
516	-		1X8L	LØ210 - Ø240 X A220	01 UN	B600000516

06

LAVA LOUÇAS
KITCHEN SINKS

94 LAVA LOUÇAS PHILIN
PHILIN KITCHEN SINKS

99 LAVA LOUÇAS INOX
STAINLESS STEEL KITCHEN SINKS

112 MISTURADORAS
FAUCETS

114 MISTURADORAS PHILIN
PHILIN FAUCETS

LAVA LOUÇAS PHILIN

PHILIN KITCHEN SINKS

PHILIN

PHILIN

LAVA LOUÇAS PHILIN

PHILIN KITCHEN SINKS



ELITE R10 400
R10 400 ELITE

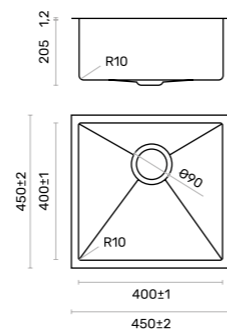

MODELO MODEL	APLICAÇÃO APPLICATION	ACABAMENTO FINISHING	MEDIDA DA PIA SINK MEASURE	PROFUNDIDADE DEPTH	CAIXA BOX	REFERÊNCIA REFERENCE
ELITE R10 400 450X450	Apl. por baixo Undermounted	SATINADO SATIN	R10 400X400	205	01 UN	LLE0004012



ELITE PE R10 1000
R10 1000 ELITE PE

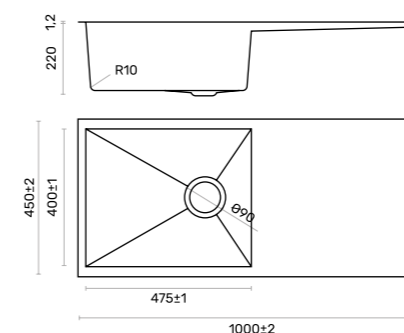

MODELO MODEL	ACABAMENTO FINISHING	MEDIDA DA PIA SINK MEASURE	PROFUNDIDADE DEPTH	CAIXA BOX	REFERÊNCIA REFERENCE
ELITE PE R10 1000 1000X450	INOX STAINLESS STEEL	R10 475X400	220	01 UN	LLEPE10012

i APLICAÇÃO POR BAIXO, APLICAÇÃO À FACE, APLICAÇÃO ENCASTRAR À SUPERFÍCIE.
INSET, UNDERMOUNTED



ELITE R10 500
R10 500 ELITE

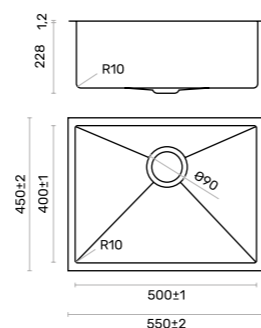

MODELO MODEL	APLICAÇÃO APPLICATION	ACABAMENTO FINISHING	MEDIDA DA PIA SINK MEASURE	PROFUNDIDADE DEPTH	CAIXA BOX	REFERÊNCIA REFERENCE
ELITE R10 500 550X450	Apl. por baixo Undermounted	SATINADO SATIN	R10 500X400	228	01 UN	LLE0005012
		PVD OURO PVD GOLD				LLE0005006
		PVD ROSA DOURADO PVD GOLDEN ROSE				LLE0005040

MYTHOS Ø370
Ø370 MYTHOS

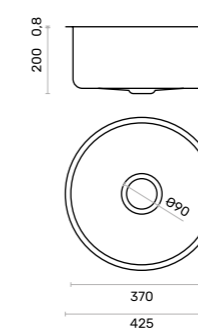

MODELO MODEL	APLICAÇÃO APPLICATION	ACABAMENTO FINISHING	MEDIDA DA PIA SINK MEASURE	PROFUNDIDADE DEPTH	CAIXA BOX	REFERÊNCIA REFERENCE
MYTHOS Ø370 Ø425	Encastrar Inset	SATINADO SATIN	R20 Ø370	200	01 UN	LLM0003712

SMART R20 300
R20 300 SMART

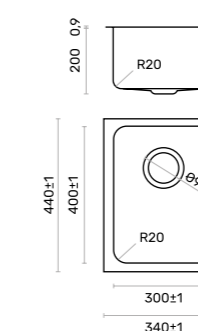

SMART R20 400
R20 400 SMART

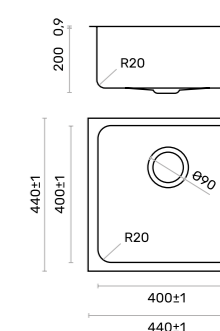

MODELO MODEL	APLICAÇÃO APPLICATION	ACABAMENTO FINISHING	MEDIDA DA PIA SINK MEASURE	PROFUNDIDADE DEPTH	CAIXA BOX	REFERÊNCIA REFERENCE
ELITE R10 700 750X450	Apl. por baixo Undermounted	SATINADO SATIN	R10 700X400	220	01 UN	LLE0007012

MODELO MODEL	APLICAÇÃO APPLICATION	ACABAMENTO FINISHING	MEDIDA DA PIA SINK MEASURE	PROFUNDIDADE DEPTH	CAIXA BOX	REFERÊNCIA REFERENCE
SMART R20 300 450X350	Apl. por baixo Undermounted	SATINADO SATIN	R20 300X400	200	01 UN	LLS0003012
SMART R20 400 450X450	Apl. por baixo Undermounted	SATINADO SATIN	R20 400X400	200	01 UN	LLS0004012

LAVA LOUÇAS PHILIN

PHILIN KITCHEN SINKS

PHILIN

PHILIN

LAVA LOUÇAS PHILIN

PHILIN KITCHEN SINKS

SMART R20 450

R20 450 SMART

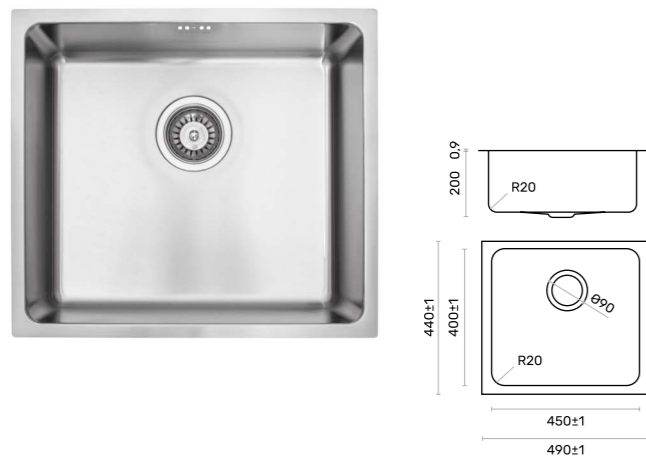

SMART R20 500

R20 500 SMART



MODELO MODEL	APLICAÇÃO APPLICATION	ACABAMENTO FINISHING	MEDIDA DA PIA SINK MEASURE	PROFUNDIDADE DEPTH	CAIXA BOX	REFERÊNCIA REFERENCE
SMART R20 450 500X450	Apl. por baixo Undermounted	SATINADO SATIN	R20 450X400	200	01 UN	LLS0004512
SMART R20 500 550X450	Apl. por baixo Undermounted	SATINADO SATIN	R20 500X400	200	01 UN	LLS0005012

SMART PP R20 765

R20 765 SMART PP

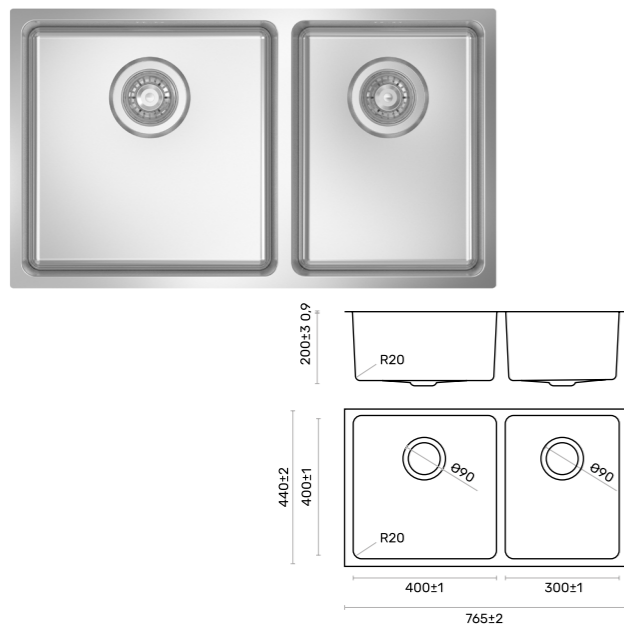

SMART PP R20 865

R20 865 SMART PP

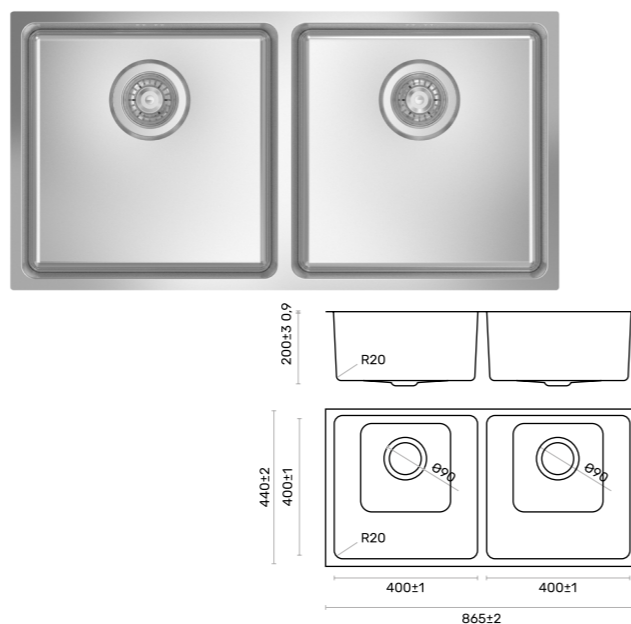

MODELO MODEL	APLICAÇÃO APPLICATION	ACABAMENTO FINISHING	MEDIDA DA PIA SINK MEASURE	PROFUNDIDADE DEPTH	CAIXA BOX	REFERÊNCIA REFERENCE
SMART PP R20 765 765X440	Apl. por baixo Undermounted	INOX STAINLESS STEEL	R20 400X400/400X300	200	01 UN	LLSPP76512
SMART PP R20 865 865X440	Apl. por baixo Undermounted	INOX STAINLESS STEEL	R20 400X400	200	01 UN	LLSPP86512

SUBLIME R10 400

R10 400 SUBLIME

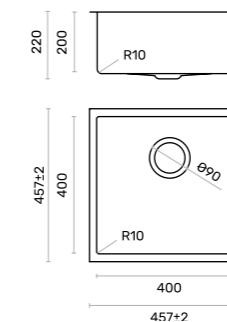

MODELO MODEL	APLICAÇÃO APPLICATION	ACABAMENTO FINISHING	MEDIDA DA PIA SINK MEASURE	PROF. INTERIOR INTERIOR DEPTH	CAIXA BOX	REFERÊNCIA REFERENCE
SUBLIME R10 400 457X457	Apl. por baixo Undermounted	BRANCO WHITE PRETO BLACK	R10 400X400	200	01 UN	LLCS004003 LLCS004009

SUBLIME R10 500

R10 500 SUBLIME

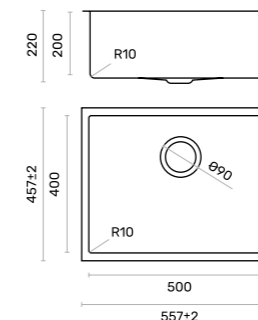

MODELO MODEL	APLICAÇÃO APPLICATION	ACABAMENTO FINISHING	MEDIDA DA PIA SINK MEASURE	PROF. INTERIOR INTERIOR DEPTH	CAIXA BOX	REFERÊNCIA REFERENCE
SUBLIME R10 500 557X457	Apl. por baixo Undermounted	BRANCO WHITE PRETO BLACK	R10 500X400	200	01 UN	LLCS005003 LLCS005009

SUBLIME R10 700

R10 700 SUBLIME

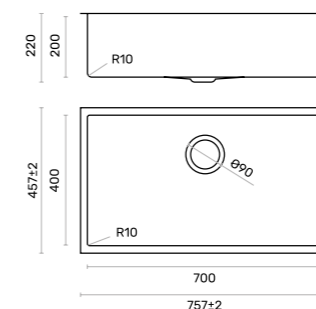

MODELO MODEL	APLICAÇÃO APPLICATION	ACABAMENTO FINISHING	MEDIDA DA PIA SINK MEASURE	PROF. INTERIOR INTERIOR DEPTH	CAIXA BOX	REFERÊNCIA REFERENCE
SUBLIME R10 700 757X457	Apl. por baixo Undermounted	BRANCO WHITE PRETO BLACK	R10 700X400	200	01 UN	LLCS007003 LLCS007009

LAVA LOUÇAS PHILIN

PHILIN KITCHEN SINKS

PHILIN

COMPOSITO

LAVA LOUÇAS

KITCHEN SINKS

SUBLIME PE

SUBLIME PE

SUBLIME PPE

SUBLIME PPE

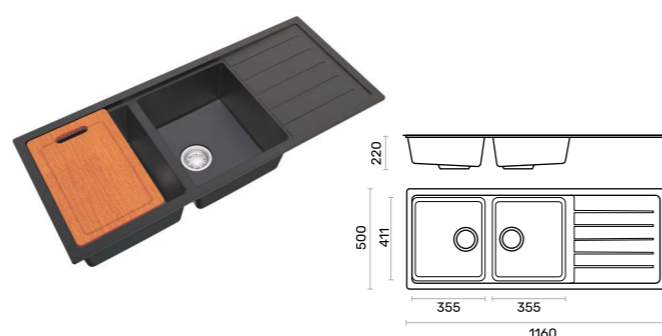
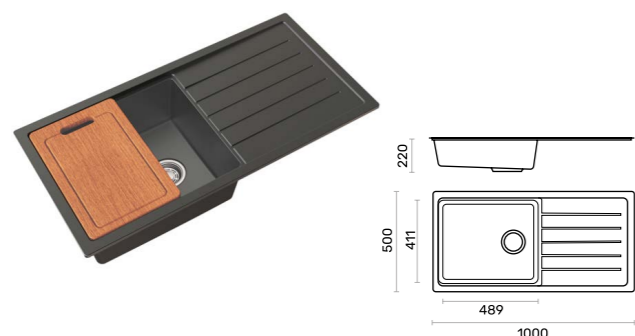

MODELO MODEL	APLICAÇÃO APPLICATION	ACABAMENTO FINISHING	MEDIDA DA PIA SINK MEASURE	PROFUNDIDADE DEPTH	CAIXA BOX	REFERÊNCIA REFERENCE
SUBLIME PE 1000X500	Encastrar Inset	BRANCO WHITE	R10 489x411	220	01 UN	LLCSPE1003
		PRETO BLACK				LLCSPE1009
SUBLIME PPE 1160X500	Encastrar Inset	BRANCO WHITE	R10 355x411	220	01 UN	LLCSPE1203
		PRETO BLACK				LLCSPE1209
TÁBUA DE CORTE CSPE	-	-	426x280x22	-	10 UN	LLCBCSPE67

TAMANHO MÍNIMO DO MÓVEL: 450MM
MINIMUM CABINET SIZE: 450MM

ELEMENT 86

ELEMENT 86

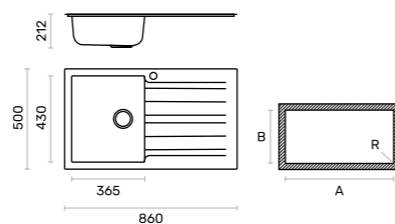

MODELO MODEL	APLICAÇÃO APPLICATION	ACABAMENTO FINISHING	MEDIDAS MEASURES	MEDIDA DA PIA SINK MEASURE	PROFUNDIDADE DEPTH	CAIXA BOX	REFERÊNCIA REFERENCE
ELEMENT 86 860X500	Encastrar Inset	PRETO BLACK	R0 A836 X B472	365X430	212	01 UN	CPE44086

TAMANHO MÍNIMO DO MÓVEL: 450MM
MINIMUM CABINET SIZE: 450MM

M 32001

M 32001

M 13000

M 13000

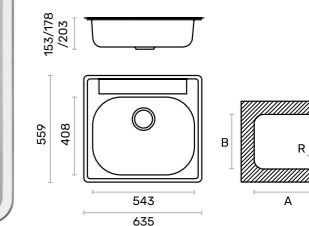
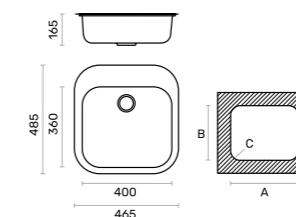

MODELO MODEL	APLICAÇÃO APPLICATION	ACABAMENTO FINISHING	MEDIDAS MEASURES	MEDIDA DA PIA SINK MEASURE	PROFUNDIDADE DEPTH	CAIXA BOX	REFERÊNCIA REFERENCE
M 32001 465X485	Encastrar Inset	POLIDO POLISHED	A445 X B465 X C140	400X360	165	01 UN	E32001
M 13000 635X559	Encastrar Inset	POLIDO POLISHED	A620 x B540	543X408	153	01 UN	E13153
	Apl. por baixo Undermounted						A543 x B408

TAMANHO MÍNIMO DO MÓVEL: 500MM
MINIMUM CABINET SIZE: 500MM

F 16702

F 16702

F 16703

F 16703

F 16704

F 16704

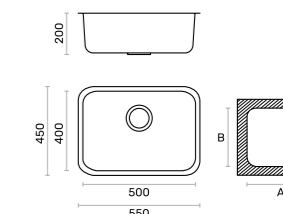
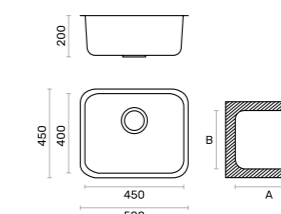
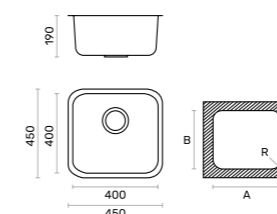

MODELO MODEL	APLICAÇÃO APPLICATION	ACABAMENTO FINISHING	MEDIDAS MEASURES	MEDIDA DA PIA SINK MEASURE	PROFUNDIDADE DEPTH	CAIXA BOX	REFERÊNCIA REFERENCE
F 16702 450X450	Apl. por baixo Undermounted	POLIDO POLISHED	R63 A405 X B405	400x400	190	05 UN	LL70F16702
F 16703 500X450	Apl. por baixo Undermounted		R63 A455 X B405	450x400	200	05 UN	LL70F16703
F 16704 550X450	Apl. por baixo Undermounted		R63 A505 X B405	450x400	200	05 UN	LL70F16704

LAVA LOUÇAS INOX

STAINLESS STEEL KITCHEN SINKS

IBERICO 50

IBERICO 50

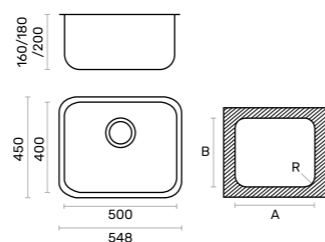

MODELO MODEL	APLICAÇÃO APPLICATION	ACABAMENTO FINISHING	MEDIDAS MEASURES	MEDIDA DA PIA SINK MEASURE	PROFUNDIDADE DEPTH	CAIXA BOX	REFERÊNCIA REFERENCE
IBERICO 50 548X450	Enc. à face/Superfície Flushmounted	● POLIDO POLISHED	R70 A544 X B444 A520 X B420	500X400	160	01 UN	E30004
	Apl. por baixo Undermounted		R56 A492 X B392				U30003
	Enc. à face/Superfície Flushmounted	● POLIDO POLISHED	R70 A544 X B444 A520 X B420	500X400	180	01 UN	E30006
	Apl. por baixo Undermounted		R56 A492 X B392				U30005
	Enc. à face/Superfície Flushmounted	● POLIDO POLISHED	R70 A544 X B444 A520 X B420	500X400	200	01 UN	E30002
	Apl. por baixo Undermounted		R56 A492 X B392				U30001

i TAMANHO MÍNIMO DO MÓVEL: 600MM
MINIMUM CABINET SIZE: 600MM

LAVA LOUÇAS INOX

STAINLESS STEEL KITCHEN SINKS

IBERICO 40

IBERICO 40

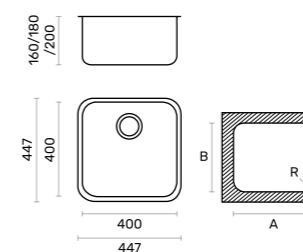

MODELO MODEL	APLICAÇÃO APPLICATION	ACABAMENTO FINISHING	MEDIDAS MEASURES	MEDIDA DA PIA SINK MEASURE	PROFUNDIDADE DEPTH	CAIXA BOX	REFERÊNCIA REFERENCE
IBERICO 40 447X447	Enc. à face/Superfície Flushmounted	● POLIDO POLISHED	R77 A444 X B444 A420 X B420	400X400	160	01 UN	E25004
	Apl. por baixo Undermounted		R56 A392 X B392				U25003
	Enc. à face/Superfície Flushmounted	● POLIDO POLISHED	R77 A444 X B444 A420 X B420	400X400	180	01 UN	E25006
	Apl. por baixo Undermounted		R56 A392 X B392				U25005
	Enc. à face/Superfície Flushmounted	● POLIDO POLISHED	R77 A444 X B444 A420 X B420	400X400	200	01 UN	E25002
	Apl. por baixo Undermounted		R56 A392 X B392				U25001

i TAMANHO MÍNIMO DO MÓVEL: 500MM
MINIMUM CABINET SIZE: 500MM

IBERICO 45

IBERICO 45

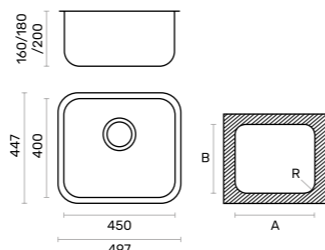

MODELO MODEL	APLICAÇÃO APPLICATION	ACABAMENTO FINISHING	MEDIDAS MEASURES	MEDIDA DA PIA SINK MEASURE	PROFUNDIDADE DEPTH	CAIXA BOX	REFERÊNCIA REFERENCE
IBERICO 45 497X447	Enc. à face/Superfície Flushmounted	● POLIDO POLISHED	R70 A494 X B444 A470 X B420	450X400	160	01 UN	E33004
	Apl. por baixo Undermounted		R56 A442 X B392				U33003
	Enc. à face/Superfície Flushmounted	● POLIDO POLISHED	R70 A494 X B444 A470 X B420	450X400	180	01 UN	E33006
	Apl. por baixo Undermounted		R56 A442 X B392				U33005
	Enc. à face/Superfície Flushmounted	● POLIDO POLISHED	R70 A494 X B444 A470 X B420	450X400	200	01 UN	E33002
	Apl. por baixo Undermounted		R56 A442 X B392				U33001

i TAMANHO MÍNIMO DO MÓVEL: 500MM
MINIMUM CABINET SIZE: 500MM

IBERICO 34

IBERICO 34

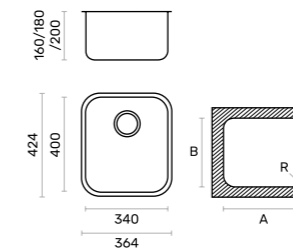

MODELO MODEL	APLICAÇÃO APPLICATION	ACABAMENTO FINISHING	MEDIDAS MEASURES	MEDIDA DA PIA SINK MEASURE	PROFUNDIDADE DEPTH	CAIXA BOX	REFERÊNCIA REFERENCE
IBERICO 34 364X424	Enc. à face/Superfície Flushmounted	● POLIDO POLISHED	R70 A384 X B444 A360 X B420	340X400	160	01 UN	E31004
	Apl. por baixo Undermounted		R56 A332 X B392				U31003
	Enc. à face/Superfície Flushmounted	● POLIDO POLISHED	R70 A384 X B444 A360 X B420	340X400	180	01 UN	E31006
	Apl. por baixo Undermounted		R56 A332 X B392				U31005
	Enc. à face/Superfície Flushmounted	● POLIDO POLISHED	R70 A384 X B444 A360 X B420	340X400	200	01 UN	E31002
	Apl. por baixo Undermounted		R56 A332 X B392				U31001

i TAMANHO MÍNIMO DO MÓVEL: 450MM
MINIMUM CABINET SIZE: 450MM

LAVA LOUÇAS INOX

STAINLESS STEEL KITCHEN SINKS

M 5000

M 5000

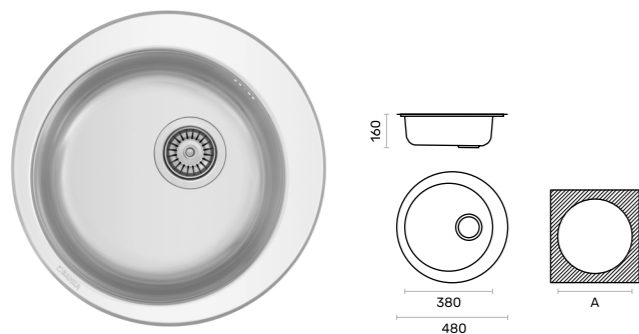

i TAMANHO MÍNIMO DO MÓVEL: 600MM
MINIMUM CABINET SIZE: 600MM

MODELO MODEL	APLICAÇÃO APPLICATION	ACABAMENTO FINISHING	MEDIDAS MEASURES	MEDIDA DA PIA SINK MEASURE	PROFUNDIDADE DEPTH	CAIXA BOX	REFERÊNCIA REFERENCE
M 5000 Ø480	Encastrar Inset	POLIDO POLISHED	AØ455	Ø380	160	01 UN	E5160
M 8160 Ø450	Encastrar Inset	POLIDO POLISHED	AØ425	Ø380	160	01 UN	E8160
	Apl. por baixo Undermounted		AØ380				U8160

M 8160

M 8160

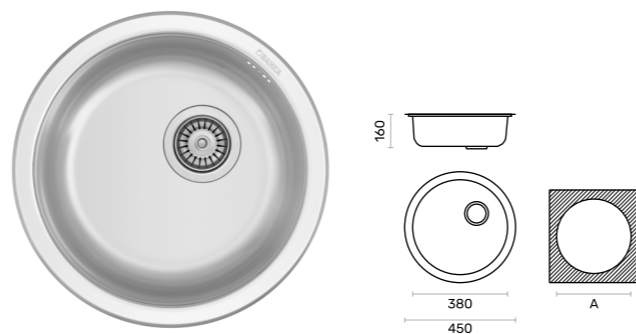

i TAMANHO MÍNIMO DO MÓVEL: 450MM
MINIMUM CABINET SIZE: 450MM

M 9046

M 9046

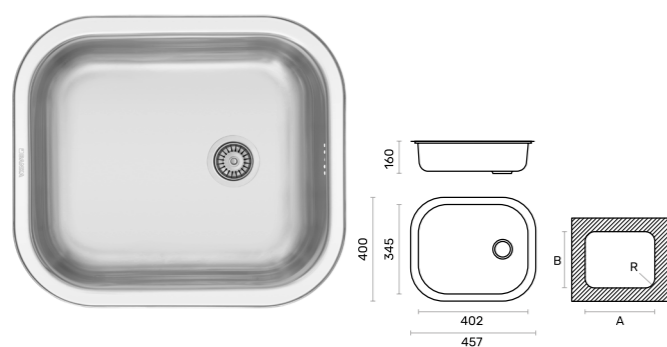

i TAMANHO MÍNIMO DO MÓVEL: 450MM
MINIMUM CABINET SIZE: 450MM

MODELO MODEL	APLICAÇÃO APPLICATION	ACABAMENTO FINISHING	MEDIDAS MEASURES	MEDIDA DA PIA SINK MEASURE	PROFUNDIDADE DEPTH	CAIXA BOX	REFERÊNCIA REFERENCE
M 9046 457X400	Encastrar Inset	POLIDO POLISHED	R103 A438 X B380	402X345	160	01 UN	E9046
	Apl. por baixo Undermounted		R95 A402 X B349				U9046
M 9054 542X402	Encastrar Inset	POLIDO POLISHED	R103 A518 X B380	482X345	160	01 UN	E9054
	Apl. por baixo Undermounted		R95 A482 X B342				U9054

i TAMANHO MÍNIMO DO MÓVEL: 600MM
MINIMUM CABINET SIZE: 600MM

LAVA LOUÇAS INOX

STAINLESS STEEL KITCHEN SINKS

BALANCE 100-15

BALANCE 100-15

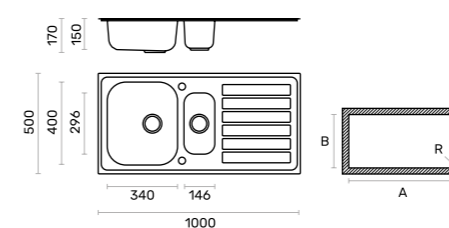

MODELO MODEL	APLICAÇÃO APPLICATION	ACABAMENTO FINISHING	MEDIDAS MEASURES	MEDIDA DA PIA SINK MEASURE	PROFUNDIDADE DEPTH	CAIXA BOX	REFERÊNCIA REFERENCE
BALANCE 100-15 1000X500	Encastrar Inset	POLIDO POLISHED	R10 A980 X B480	340X400/146X296	170/150	01 UN	E42102

i TAMANHO MÍNIMO DO MÓVEL: 600MM
MINIMUM CABINET SIZE: 600MM

BALANCE 80-1

BALANCE 80-1

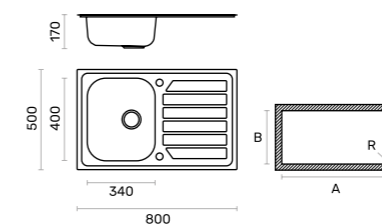

MODELO MODEL	APLICAÇÃO APPLICATION	ACABAMENTO FINISHING	MEDIDAS MEASURES	MEDIDA DA PIA SINK MEASURE	PROFUNDIDADE DEPTH	CAIXA BOX	REFERÊNCIA REFERENCE
BALANCE 80-1 800X500	Encastrar Inset	POLIDO POLISHED	R10 A780 X B480	340X400	170	01 UN	E42080
		MATE MATTE					E42080NP

i TAMANHO MÍNIMO DO MÓVEL: 450MM
MINIMUM CABINET SIZE: 450MM

BALANCE 80-2

BALANCE 80-2

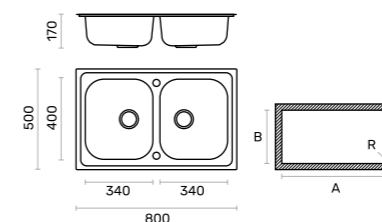

MODELO MODEL	APLICAÇÃO APPLICATION	ACABAMENTO FINISHING	MEDIDAS MEASURES	MEDIDA DA PIA SINK MEASURE	PROFUNDIDADE DEPTH	CAIXA BOX	REFERÊNCIA REFERENCE
BALANCE 80-2 800X500	Encastrar Inset	POLIDO POLISHED	R10 A780 X B480	340X400	170	01 UN	E42082
		MATE MATTE					E42082NP

i TAMANHO MÍNIMO DO MÓVEL: 800MM
MINIMUM CABINET SIZE: 800MM

LAVA LOUÇAS INOX

STAINLESS STEEL KITCHEN SINKS



BALANCE 120
BALANCE 120

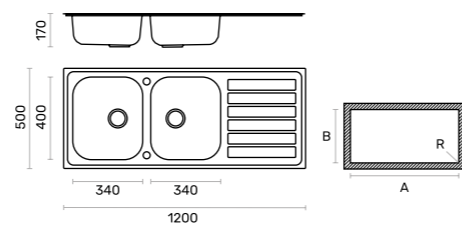

MODELO MODEL	APLICAÇÃO APPLICATION	ACABAMENTO FINISHING	MEDIDAS MEASURES	MEDIDA DA PIA SINK MEASURE	PROFUNDIDADE DEPTH	CAIXA BOX	REFERÊNCIA REFERENCE
BALANCE 120 1200X500	Encastrar Inset	POLIDO POLISHED	R10	A1180 X B480	340X400	170	E42120
		MATE MATTE					E42120NP

i TAMANHO MÍNIMO DO MÓVEL: 800MM
MINIMUM CABINET SIZE: 800MM



BALANCE 100-50
BALANCE 100-50

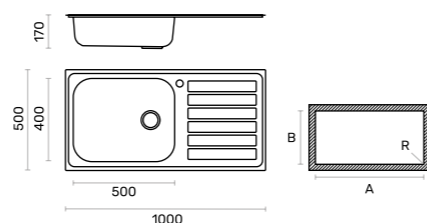

MODELO MODEL	APLICAÇÃO APPLICATION	ACABAMENTO FINISHING	MEDIDAS MEASURES	MEDIDA DA PIA SINK MEASURE	PROFUNDIDADE DEPTH	CAIXA BOX	REFERÊNCIA REFERENCE
BALANCE 100-50 1000X500	Encastrar Inset	POLIDO POLISHED	R10	A980 X B480	500X400	170	01 UN E42100

i TAMANHO MÍNIMO DO MÓVEL: 800MM
MINIMUM CABINET SIZE: 800MM



BALANCE 100-34
BALANCE 100-34

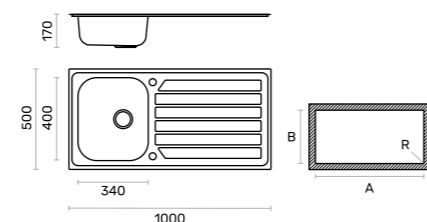

MODELO MODEL	APLICAÇÃO APPLICATION	ACABAMENTO FINISHING	MEDIDAS MEASURES	MEDIDA DA PIA SINK MEASURE	PROFUNDIDADE DEPTH	CAIXA BOX	REFERÊNCIA REFERENCE
BALANCE 100-34 1000X500	Encastrar Inset	POLIDO POLISHED	R10	A980 X B480	340X400	170	E42101
		MATE MATTE					E42101NP

i TAMANHO MÍNIMO DO MÓVEL: 450MM
MINIMUM CABINET SIZE: 450MM

LAVA LOUÇAS INOX

STAINLESS STEEL KITCHEN SINKS

M 6045
M 6045

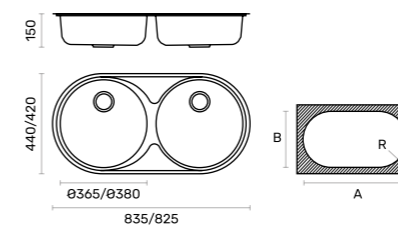

MODELO MODEL	APLICAÇÃO APPLICATION	ACABAMENTO FINISHING	MEDIDAS MEASURES	MEDIDA DA PIA SINK MEASURE	PROFUNDIDADE DEPTH	CAIXA BOX	REFERÊNCIA REFERENCE
M 6045 835X440	Encastrar Inset	POLIDO POLISHED	R208	A811 X B416	150	01 UN	E6045
		MATE MATTE					E6045NP
M 6045 835X440	Apl. por baixo Undermounted	POLIDO POLISHED	R190	A785 X B380	150	01 UN	U6045
		MATE MATTE					U6045NP

i TAMANHO MÍNIMO DO MÓVEL: 800MM
MINIMUM CABINET SIZE: 800MM

M 7045
M 7045

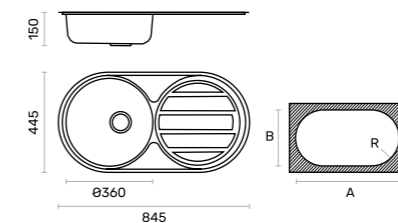

MODELO MODEL	APLICAÇÃO APPLICATION	ACABAMENTO FINISHING	MEDIDAS MEASURES	MEDIDA DA PIA SINK MEASURE	PROFUNDIDADE DEPTH	CAIXA BOX	REFERÊNCIA REFERENCE
M 7045 845X445	Encastrar Inset	POLIDO POLISHED	R213,5	A820 X B427	150	01 UN	E7045
		MATE MATTE					E7045NP

i TAMANHO MÍNIMO DO MÓVEL: 600MM
MINIMUM CABINET SIZE: 600MM

M 11000
M 11000

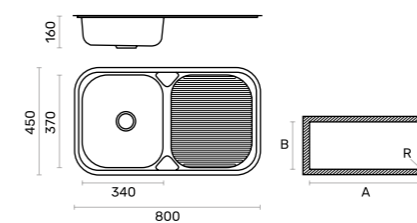

MODELO MODEL	APLICAÇÃO APPLICATION	ACABAMENTO FINISHING	MEDIDAS MEASURES	MEDIDA DA PIA SINK MEASURE	PROFUNDIDADE DEPTH	CAIXA BOX	REFERÊNCIA REFERENCE
M 11000 800X450	Encastrar Inset	POLIDO POLISHED	R130	A778 X B428	340X370	160	01 UN E11084

i TAMANHO MÍNIMO DO MÓVEL: 500MM
MINIMUM CABINET SIZE: 500MM

LAVA LOUÇAS INOX

STAINLESS STEEL KITCHEN SINKS



F 16720
F 16720

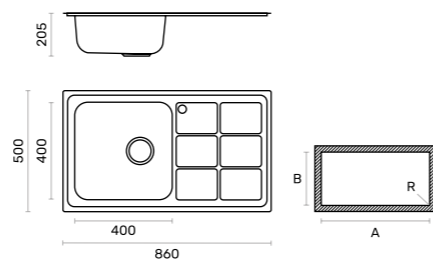

MODELO MODEL	APLICAÇÃO APPLICATION	ACABAMENTO FINISHING	MEDIDAS MEASURES	MEDIDA DA PIA SINK MEASURE	PROFUNDIDADE DEPTH	CAIXA BOX	REFERÊNCIA REFERENCE
F 16720 860X500	Encastrar Inset	POLIDO POLISHED	R10 A845 X B485	400X400	205	01 UN	LL70F16720

LAVA LOUÇAS INOX

STAINLESS STEEL KITCHEN SINKS

MORFUS DEEP
MORFUS DEEP

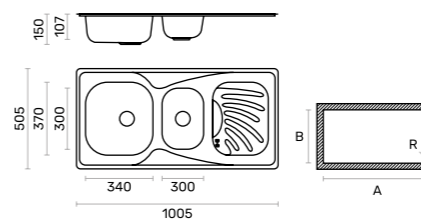

MODELO MODEL	APLICAÇÃO APPLICATION	ACABAMENTO FINISHING	MEDIDAS MEASURES	MEDIDA DA PIA SINK MEASURE	PROFUNDIDADE DEPTH	CAIXA BOX	REFERÊNCIA REFERENCE
MORFUS DEEP 1005X505	Encastrar Inset	POLIDO POLISHED	R25 A970 X B480	340X370/300X300	150/107	01 UN	E18002

i TAMANHO MÍNIMO DO MÓVEL: 800MM
MINIMUM CABINET SIZE: 800MM

F 16742
F 16742

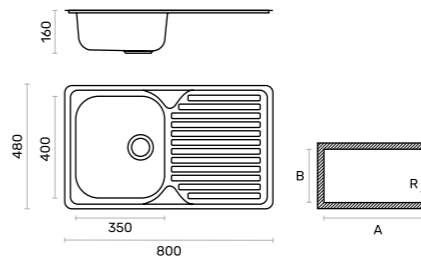

MODELO MODEL	APLICAÇÃO APPLICATION	ACABAMENTO FINISHING	MEDIDAS MEASURES	MEDIDA DA PIA SINK MEASURE	PROFUNDIDADE DEPTH	CAIXA BOX	REFERÊNCIA REFERENCE
F 16742 800X480	Encastrar Inset	POLIDO POLISHED	R10 A780 X B460	350X400	160	05 UN	LL70F16742

F 16743
F 16743

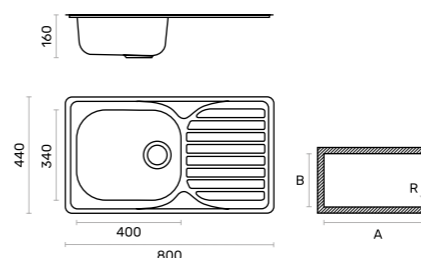

MODELO MODEL	APLICAÇÃO APPLICATION	ACABAMENTO FINISHING	MEDIDAS MEASURES	MEDIDA DA PIA SINK MEASURE	PROFUNDIDADE DEPTH	CAIXA BOX	REFERÊNCIA REFERENCE
F 16743 800X440	Encastrar Inset	POLIDO POLISHED	R10 A780 X B420	400X350	160	05 UN	LL70F16743

M 26000
M 26000

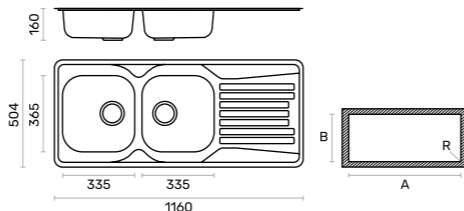

MODELO MODEL	APLICAÇÃO APPLICATION	ACABAMENTO FINISHING	MEDIDAS MEASURES	MEDIDA DA PIA SINK MEASURE	PROFUNDIDADE DEPTH	CAIXA BOX	REFERÊNCIA REFERENCE
M 26000 1160X504	Encastrar Inset	POLIDO POLISHED MATE MATTE	R25 A1130 X B480 A1120 X B470	335X365	160	01 UN	E26001 E26001NP

i TAMANHO MÍNIMO DO MÓVEL: 800MM
MINIMUM CABINET SIZE: 800MM

M 28000
M 28000

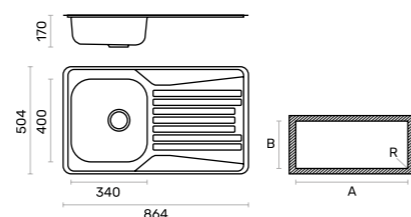

MODELO MODEL	APLICAÇÃO APPLICATION	ACABAMENTO FINISHING	MEDIDAS MEASURES	MEDIDA DA PIA SINK MEASURE	PROFUNDIDADE DEPTH	CAIXA BOX	REFERÊNCIA REFERENCE
M 28000 864X504	Encastrar Inset	POLIDO POLISHED MATE MATTE	R25 A830 X B480 A820 X B470	340X400	170	01 UN	E28001 E28001NP

i TAMANHO MÍNIMO DO MÓVEL: 450MM
MINIMUM CABINET SIZE: 450MM

LAVA LOUÇAS INOX

STAINLESS STEEL KITCHEN SINKS

LAVA LOUÇAS INOX

STAINLESS STEEL KITCHEN SINKS



M 14000
M 14000

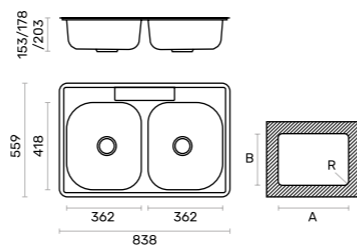

MODELO MODEL	APLICAÇÃO APPLICATION	ACABAMENTO FINISHING	MEDIDAS MEASURES	MEDIDA DA PIA SINK MEASURE	PROFUNDIDADE DEPTH	CAIXA BOX	REFERÊNCIA REFERENCE
M 14000 838X559	Encastrar Inset	● POLIDO POLISHED	R20	A822 X B540	362X418	01 UN	153
							178
							203
	Apl. por baixo Undermounted	● POLIDO POLISHED	R118	A759 X B415	362X418	01 UN	153
							178
							203

TAMANHO MÍNIMO DO MÓVEL: 800MM
MINIMUM CABINET SIZE: 800MM



M 21000
M 21000

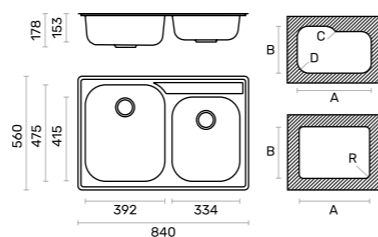

MODELO MODEL	APLICAÇÃO APPLICATION	ACABAMENTO FINISHING	MEDIDAS MEASURES	MEDIDA DA PIA SINK MEASURE	PROFUNDIDADE DEPTH	CAIXA BOX	REFERÊNCIA REFERENCE	
M 21000 840X560	Encastrar Inset	● POLIDO POLISHED	R20	A825 X B545	392X475/334X415	01 UN	E21178	
							● MATE MATTE	E21178NP
		● POLIDO POLISHED	R20	A825 X B545	392X475/334X415	203/178	01 UN	E21203
								● MATE MATTE
	Apl. por baixo Undermounted	● POLIDO POLISHED	-	A750 X B475 CR20 X DR1100	392X475/334X415	178/153	01 UN	U21178
								● MATE MATTE
							U21203	
							U21203NP	

TAMANHO MÍNIMO DO MÓVEL: 800MM
MINIMUM CABINET SIZE: 800MM

M 1081
M 1081

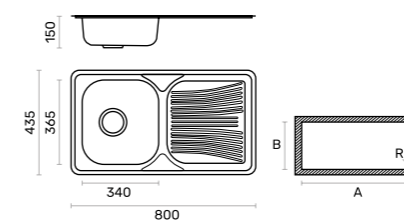

MODELO MODEL	APLICAÇÃO APPLICATION	ACABAMENTO FINISHING	MEDIDAS MEASURES	MEDIDA DA PIA SINK MEASURE	PROFUNDIDADE DEPTH	CAIXA BOX	REFERÊNCIA REFERENCE
M 1081 800X435	Encastrar Inset	● POLIDO POLISHED	R25	A778 X B420	340X365	01 UN	E1081
		● MATE MATTE					E1081NP

TAMANHO MÍNIMO DO MÓVEL: 450MM
MINIMUM CABINET SIZE: 450MM

M 2081
M 2081

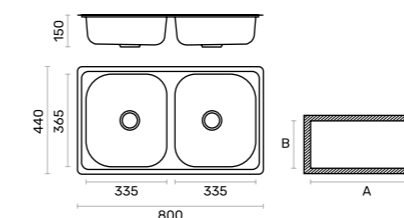

MODELO MODEL	APLICAÇÃO APPLICATION	ACABAMENTO FINISHING	MEDIDAS MEASURES	MEDIDA DA PIA SINK MEASURE	PROFUNDIDADE DEPTH	CAIXA BOX	REFERÊNCIA REFERENCE
M 2081 800X440	Encastrar Inset	● POLIDO POLISHED	R25	A780 X B420	335X365	01 UN	E2081

TAMANHO MÍNIMO DO MÓVEL: 450MM
MINIMUM CABINET SIZE: 450MM

M 10000
M 10000

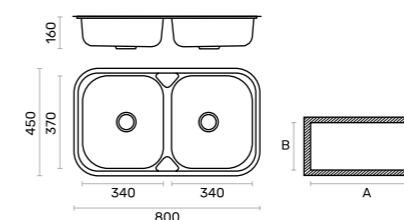

MODELO MODEL	APLICAÇÃO APPLICATION	ACABAMENTO FINISHING	MEDIDAS MEASURES	MEDIDA DA PIA SINK MEASURE	PROFUNDIDADE DEPTH	CAIXA BOX	REFERÊNCIA REFERENCE
M 10000 800X450	Encastrar Inset	● POLIDO POLISHED	R130	A778 X B428	340X370	01 UN	E10084

TAMANHO MÍNIMO DO MÓVEL: 900MM
MINIMUM CABINET SIZE: 900MM

LAVA LOUÇAS INOX

STAINLESS STEEL KITCHEN SINKS

M 3120
M 3120

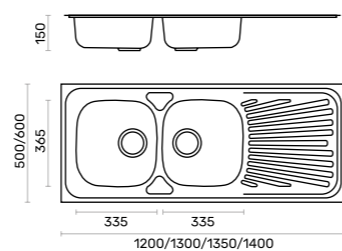
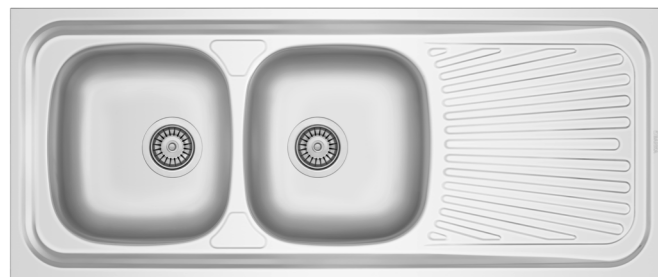

MODELO MODEL	APLICAÇÃO APPLICATION	ACABAMENTO FINISHING	MEDIDA MEASURE	MEDIDA DA PIA SINK MEASURE	PROFUNDIDADE DEPTH	CAIXA BOX	REFERÊNCIA REFERENCE
M 3120	Pousar Drop in	● MATE MATTE	1200X500				N3120NP
			1300X500	335X365	150	01 UN	N3130NP
			1350X500				N3135NP
			1400X500				N3140NP
	Pousar Drop in	● MATE MATTE	1200X600				L3120NP
			1300X600	335X365	150	01 UN	L3130NP
			1350X600				L3135NP
			1400X600				L3140NP
	Encastrar Inset	● MATE MATTE	1300X510				E3130NP
			1350X510	335X365	150	01 UN	E3135NP
			1400X510				E3140NP

M 1080
M 1080

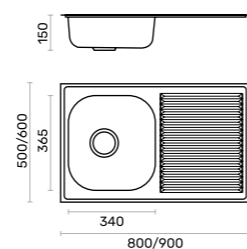

MODELO MODEL	APLICAÇÃO APPLICATION	ACABAMENTO FINISHING	MEDIDA MEASURE	MEDIDA DA PIA SINK MEASURE	PROFUNDIDADE DEPTH	CAIXA BOX	REFERÊNCIA REFERENCE
M 1080	Pousar Drop in	● MATE MATTE	800X500				N1080NP
			900X500	340X365	150	01 UN	N1090NP
			900X600				L1090NP
	Encastrar Inset	● MATE MATTE	900X510	340X365	150	01 UN	E1090NP

LAVA LOUÇAS INOX

STAINLESS STEEL KITCHEN SINKS

M 1100
M 1100

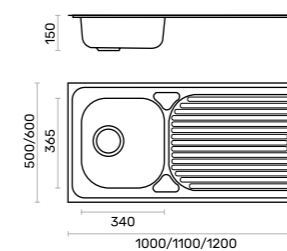

MODELO MODEL	APLICAÇÃO APPLICATION	ACABAMENTO FINISHING	MEDIDA MEASURE	MEDIDA DA PIA SINK MEASURE	PROFUNDIDADE DEPTH	CAIXA BOX	REFERÊNCIA REFERENCE		
M 1100	Pousar Drop in	● MATE MATTE	1000X500				N1100NP		
			1100X500	340X365	150	01 UN	N1110NP		
			1200X500				N1120NP		
			1000X600				L1100NP		
	Pousar Drop in	● MATE MATTE	1100X600	340X365	150	01 UN	L1110NP		
			1200X600				L1120NP		
			Encastrar Inset	● MATE MATTE	1200X510	340X365	150	01 UN	E1120NP

M 2080
M 2080

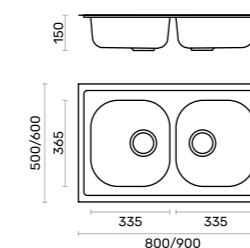

MODELO MODEL	APLICAÇÃO APPLICATION	ACABAMENTO FINISHING	MEDIDA MEASURE	MEDIDA DA PIA SINK MEASURE	PROFUNDIDADE DEPTH	CAIXA BOX	REFERÊNCIA REFERENCE
M 2080	Pousar Drop in	● MATE MATTE	800X500				N2080NP
			900X500	335X365	150	01 UN	N2090NP
			800X600				L2080NP
	Encastrar Inset	● MATE MATTE	900X600				L2090NP
			900X510	335X365	150	01 UN	E2090NP

MISTURADORAS PHILIN

PHILIN FAUCETS

PHILIN

PHILIN

MISTURADORAS PHILIN

PHILIN FAUCETS



MONTANA

MONTANA

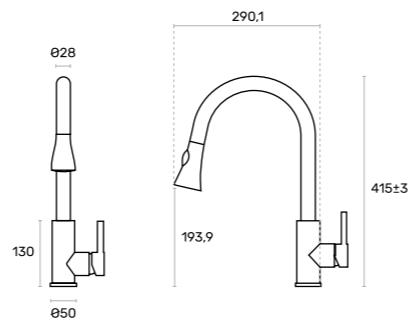

MODELO MODEL	ACABAMENTO FINISHING	MEDIDAS MEASURES	CAIXA BOX	REFERÊNCIA REFERENCE
MONTANA	● INOX STAINLESS STEEL	290.1X415±3	01 UN	K530MPH099



ARIZONA

ARIZONA

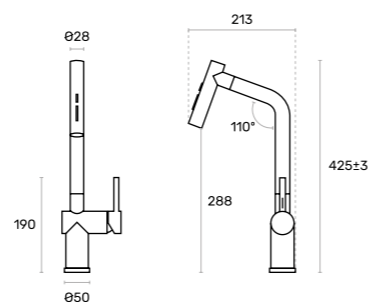

MODELO MODEL	ACABAMENTO FINISHING	MEDIDAS MEASURES	CAIXA BOX	REFERÊNCIA REFERENCE
ARIZONA	● INOX STAINLESS STEEL	213X425±3	01 UN	K530MPH128
	● PRETO BLACK	213X425±3	01 UN	K53MPH128S
	● PVD ROSA DOURADO PVD GOLDEN ROSE	213X425±3	01 UN	K53MPH128S



YORK

YORK

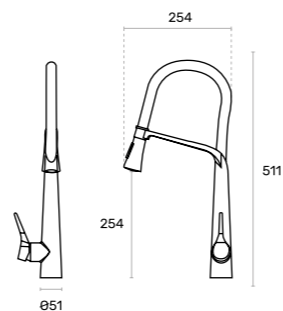

MODELO MODEL	ACABAMENTO FINISHING	MEDIDAS MEASURES	CAIXA BOX	REFERÊNCIA REFERENCE
YORK	● PRETO BLACK	254X511	01 UN	K53MPH137S
	● PVD ROSA DOURADO PVD GOLDEN ROSE	254X511	01 UN	K53MPH137S

FLORIDA

FLORIDA

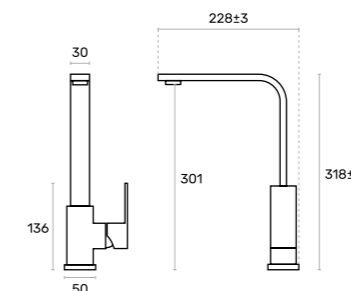

MODELO MODEL	ACABAMENTO FINISHING	MEDIDAS MEASURES	CAIXA BOX	REFERÊNCIA REFERENCE
FLORIDA	● INOX STAINLESS STEEL	228±3X318±3	01 UN	K530MPH003
	● PRETO BLACK	228±3X318±3	01 UN	K53MPH003B

COLORADO

COLORADO

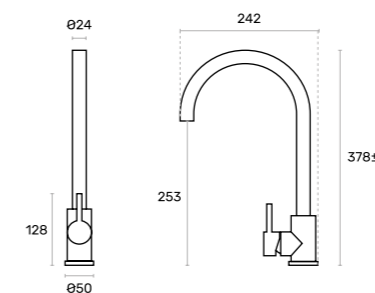

MODELO MODEL	ACABAMENTO FINISHING	MEDIDAS MEASURES	CAIXA BOX	REFERÊNCIA REFERENCE
COLORADO	● INOX STAINLESS STEEL	242X378±3	01 UN	K530MPH106
	● PRETO BLACK	242X378±3	01 UN	K53MPH106B

INDIANA

INDIANA

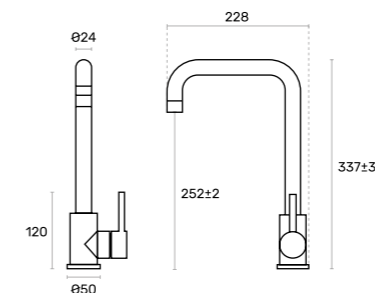

MODELO MODEL	ACABAMENTO FINISHING	MEDIDAS MEASURES	CAIXA BOX	REFERÊNCIA REFERENCE
INDIANA	● INOX STAINLESS STEEL	228X337±3	01 UN	K530MPH104



DAKOTA
DAKOTA

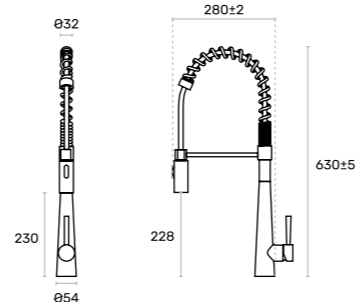

PHILIN

MODELO MODEL	ACABAMENTO FINISHING	MEDIDAS MEASURES	CAIXA BOX	REFERÊNCIA REFERENCE
DAKOTA	● INOX STAINLESS STEEL	280±2X630±5	01 UN	K530MPH096

M221152
M221152

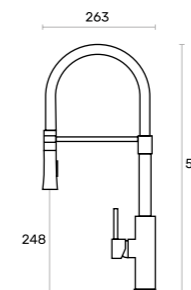

M221122
M221122

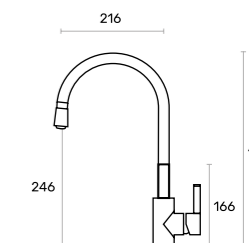

MODELO MODEL	ACABAMENTO FINISHING	MEDIDAS MEASURES	CAIXA BOX	REFERÊNCIA REFERENCE
M221152	● CROMADO CHROME ● PRETO BLACK	263X584	01 UN	K53M221152
M221122	● CROMADO CHROME ● PRETO BLACK	216X401	01 UN	K53M221122

M14022
M14022

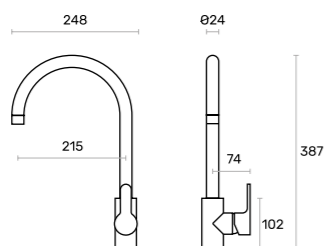

M22110
M22110

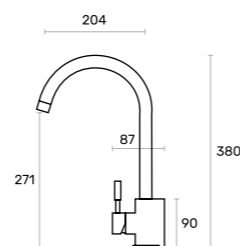

MODELO MODEL	ACABAMENTO FINISHING	MEDIDAS MEASURES	CAIXA BOX	REFERÊNCIA REFERENCE
M14022	● CROMADO CHROME	248X387	01 UN	K530M14022
M22110	● INOX STAINLESS STEEL	204X380	01 UN	K530M22110

M22105
M22105

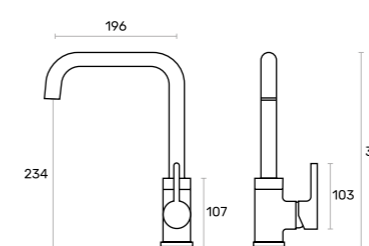

M22105B
M22105B

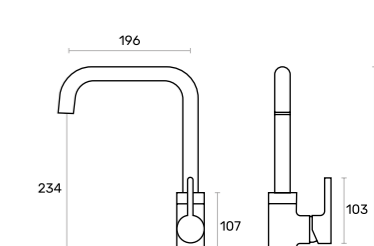

MODELO MODEL	ACABAMENTO FINISHING	MEDIDAS MEASURES	CAIXA BOX	REFERÊNCIA REFERENCE
M22105	● CROMADO CHROME	196X307	01 UN	K530M22105
M22105B	● PRETO BLACK	196X307	01 UN	K53M22105B

07

GAVETAS,
CORREDIÇAS
E LATERAIS
DRAWERS
AND SLIDES

~~118~~ **GAVETAS HAGEN**
HAGEN DRAWERS

~~121~~ **GAVETAS**
DRAWERS

~~128~~ **GAVETAS G*GRASS**
G*GRASS DRAWERS

~~130~~ **CORREDIÇAS G*GRASS**
G*GRASS SLIDES

~~131~~ **CORREDIÇAS**
SLIDES

~~133~~ **CORREDIÇAS BLANK**
BLANK SLIDES

~~135~~ **CORREDIÇAS DE MESA**
TABLE SLIDES



MODELO MODEL	ACABAMENTO FINISHING	CAIXA BOX	REFERÊNCIA REFERENCE
HAGEN H69	450	04 UN	BRANCO WHITE HGN0694503
			ANTRACITE ANTHRACITE HGN0694524
	500		BRANCO WHITE HGN0695003
			ANTRACITE ANTHRACITE HGN0695024
GAVETA HAGEN H84	350	04 UN	BRANCO WHITE HGN0843503
			ANTRACITE ANTHRACITE HGN0843524
	400		BRANCO WHITE HGN0844003
			ANTRACITE ANTHRACITE HGN1164024
	450		BRANCO WHITE HGN0844503
			ANTRACITE ANTHRACITE HGN0844524
	500		BRANCO WHITE HGN0845003
			ANTRACITE ANTHRACITE HGN0845024
GAVETA HAGEN H116	350	04 UN	BRANCO WHITE HGN1163503
			ANTRACITE ANTHRACITE HGN1163524
	400		BRANCO WHITE HGN1164003
			ANTRACITE ANTHRACITE HGN1164024
	450		BRANCO WHITE HGN1164503
			ANTRACITE ANTHRACITE HGN1164524
	500		BRANCO WHITE HGN1165003
			ANTRACITE ANTHRACITE HGN1165024
GAVETA HAGEN H167	350	04 UN	BRANCO WHITE HGN1673503
			ANTRACITE ANTHRACITE HGN1673524
	400		BRANCO WHITE HGN1674003
			ANTRACITE ANTHRACITE HGN1674024
	450		BRANCO WHITE HGN1674503
			ANTRACITE ANTHRACITE HGN1674524
	500		BRANCO WHITE HGN1675003
			ANTRACITE ANTHRACITE HGN1675024
HAGEN H199	450	04 UN	BRANCO WHITE HGN1994503
			ANTRACITE ANTHRACITE HGN1994524
	500		BRANCO WHITE HGN1995003
			ANTRACITE ANTHRACITE HGN1995024



MODELO MODEL	ACABAMENTO FINISHING	CAIXA BOX	REFERÊNCIA REFERENCE
HAGEN TIC TAC H84	350	04 UN	HGP0843524
	400		ANTRACITE ANTHRACITE HGP0844024
	450		HGP0844524
	500		HGP0845024
HAGEN TIC TAC H116	400	04 UN	HGP1164024
	450		ANTRACITE ANTHRACITE HGP1164524
	500		HGP1165024
HAGEN TIC TAC H167	350	04 UN	HGP1673524
	400		ANTRACITE ANTHRACITE HGP1674024
	450		HGP1674524
500	HGP1675024		
	350	04 UN	HGP1993524
	400		ANTRACITE ANTHRACITE HGP1994024
450	HGP1994524		
500	HGP1995024		
VARÃO DE SINCRONIZAÇÃO 1200		2 SETS	HGP0000200
HAGEN WITH RAILS H69	450	04 UN	CINZA GREY HGN0694522
	500		HGN0695022
HAGEN WITH RAILS H84	400	04 UN	PRETO BLACK HGN0844009
			CINZA GREY HGN0844522
	450		PRETO BLACK HGN0844509
			CINZA GREY HGN0845022
500	PRETO BLACK HGN0845009		
SET VARÃO	400	30 UN	CINZA GREY HGN00R4022
			PRETO BLACK HGN00R4009
	450		CINZA GREY HGN00R4522
			PRETO BLACK HGN00R4509
	500		CINZA GREY HGN00R5022
			PRETO BLACK HGN00R5009



MODELO MODEL	N° N°	DESCRIÇÃO DESCRIPTION	ACABAMENTO FINISHING	CAIXA BOX	REFERÊNCIA REFERENCE
GAVETA HAGEN H84	01	BARRA FRONTAL 1200 INTERIOR H84 H84 INTERNAL PANEL 1200 INTERIOR	BRANCO WHITE	01 UN	HGN0840003
			● ANTRACITE ANTHRACITE		HGN0840024
	02	FIXADOR FRONTAL INTERIOR H84 H84 COVER CAP SET	BRANCO WHITE		HGN0840103
			● ANTRACITE ANTHRACITE		HGN0840124
GAVETA HAGEN H116	01	BARRA FRONTAL 1200 INTERIOR H116 H116 INTERNAL PANEL 1200 INTERIOR	BRANCO WHITE	01 UN	HGN1160003
			● ANTRACITE ANTHRACITE		HGN1160024
	02	FIXADOR FRONTAL INTERIOR H116 H116 COVER CAP SET	BRANCO WHITE		HGN1160103
			● ANTRACITE ANTHRACITE		HGN1160124
GAVETA HAGEN H167	01	BARRA FRONTAL 1200 INTERIOR H167 H167 INTERNAL PANEL 1200 INTERIOR	BRANCO WHITE	01 UN	HGN1670003
			● ANTRACITE ANTHRACITE		HGN1670024
	02	FIXADOR FRONTAL INTERIOR H167 H167 COVER CAP SET	BRANCO WHITE		HGN1670103
			● ANTRACITE ANTHRACITE		HGN1670124
GAVETA HAGEN H199	01	BARRA FRONTAL 1200 INTERIOR H199 H199 INTERNAL PANEL 1200 INTERIOR	BRANCO WHITE	01 UN	HGN1990003
			● ANTRACITE ANTHRACITE		HGN1990024
	02	FIXADOR FRONTAL INTERIOR H199 H199 COVER CAP SET	BRANCO WHITE		HGN1990103
			● ANTRACITE ANTHRACITE		HGN1990124



GAVETA J001
J001 DRAWER



GAVETA J002
J002 DRAWER



GAVETA J004
J004 DRAWER



MODELO MODEL	COMPRIMENTO LENGTH	PESO WEIGHT	CAIXA BOX	REFERÊNCIA REFERENCE
GAVETA J001	300	30 KG	06 UN	G20000222
	350			G20000322
	400			G20000422
	450			G20000522
	500			G20000622
	550			G20000722
GAVETA J002	270	30 KG	06 UN	G20000822
	300			G20000922
	350			G20001022
	400			G20001122
	450			G20001222
	500			G20001322
GAVETA J004	550	30 KG	06 UN	G20001422
	350			G20001622
	400			G20001722
	450			G20001822
	500			G20001922
	550			G20002022

GAVETAS INTERIORES
INNER DRAWERS

MODELO MODEL	N° N°	DESCRIÇÃO DESCRIPTION	CAIXA BOX	REFERÊNCIA REFERENCE
GAVETAS INTERIORES	1	BARRA FRONTAL PARA GAVETA INTERIOR 1100 J001 INTERNAL PANEL	01 UN	G200004222
	2	FIXADOR FRONTAL PARA GAVETA INTERIOR J001 COVER CAP SET		G200004322
	3	BARRA FRONTAL PARA GAVETÃO INTERIOR 1200 J004 INTERNAL PANEL 1200		G200004422
	4	FIXADOR FRONTAL PARA GAVETÃO INTERIOR J004 COVER CAP SET		G200004522
	5	VARÃO FRONTAL PARA GAVETÃO INTERIOR 1200 J004 CROSS RAIL 1200		G200004622
	6	PUXADOR PLÁSTICO PARA GAVETÃO INTERIOR J004 INTERNAL DRAWER HANDLE		G200004722

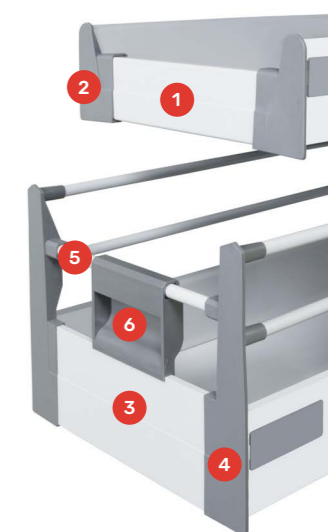



GAVETA DTC E1
DTC E1 DRAWER

MODELO MODEL	COMPRIMENTO LENGHT	ACABAMENTO FINISHING	PESO WEIGHT	CAIXA BOX	REFERÊNCIA REFERENCE
GAVETA DTC E1	270	<input type="radio"/> BRANCO WHITE <input type="radio"/> CINZA GREY	40 KG	01 UN	G200006302
	350	<input type="radio"/> BRANCO WHITE <input type="radio"/> CINZA GREY			G200006322
		<input type="radio"/> BRANCO WHITE <input type="radio"/> CINZA GREY			G200006502
	400	<input type="radio"/> BRANCO WHITE <input type="radio"/> CINZA GREY			G200006522
		<input type="radio"/> BRANCO WHITE <input type="radio"/> CINZA GREY			G200006602
	450	<input type="radio"/> BRANCO WHITE <input type="radio"/> CINZA GREY			G200006622
		<input type="radio"/> BRANCO WHITE <input type="radio"/> CINZA GREY			G200006702
	500	<input type="radio"/> BRANCO WHITE <input type="radio"/> CINZA GREY			G200006722
		<input type="radio"/> BRANCO WHITE <input type="radio"/> CINZA GREY			G200006802
	550	<input type="radio"/> BRANCO WHITE <input type="radio"/> CINZA GREY			G200006822
<input type="radio"/> BRANCO WHITE <input type="radio"/> CINZA GREY		G200006922			
GAVETA DTC E1	500	<input type="radio"/> CINZA GREY	50 KG	01 UN	G200007022
GAVETA DTC E1 TIC-TAC	350	<input type="radio"/> CINZA GREY			G200007222
	400				G200007322
	450				G200007422
	500				G200007522
VARÃO SINCRONIZAÇÃO 1100				60 UN	G200008700
ADAPTADOR P/VARÃO SINCRONIZAÇÃO GAVETA E1 TIC-TAC				60 UN	G200008800

GAVETA INTERIOR DTC E1
DTC E1 INNER DRAWER



MODELO MODEL	DESCRIÇÃO DESCRIPTION	ACABAMENTO FINISHING	CAIXA BOX	REFERÊNCIA REFERENCE
01	GAVETA INTERIOR DTC E1 BARRA FRONTAL 1100 DTC INTERNAL PANEL 1100	<input type="radio"/> BRANCO WHITE	20 UN	G200007602
		<input type="radio"/> CINZA GREY		G200008422
02	FIXADOR FRONTAL DTC E1 COVER CAP SET	<input type="radio"/> BRANCO WHITE	60 UN	G200007702
		<input type="radio"/> CINZA GREY		G200007722

GAVETÃO MÉDIO INTERIOR DTC E2R
DTC E2R MEDIUM INNER DRAWER



GAVETÃO MÉDIO INTERIOR DTC E2Q
DTC E2Q MEDIUM INNER DRAWER

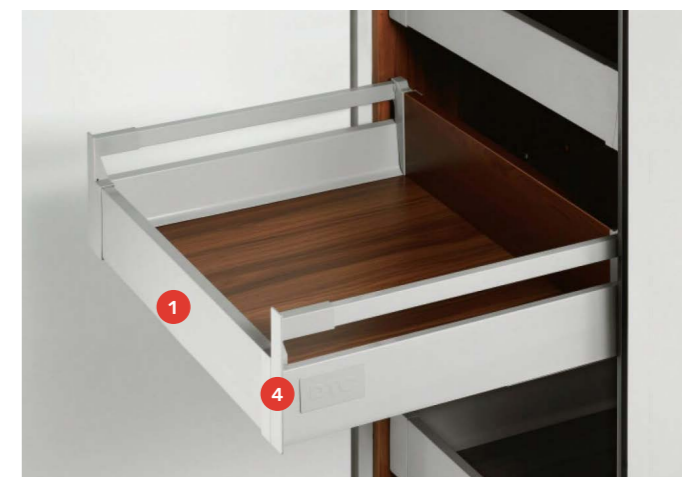

MODELO MODEL	DESCRIÇÃO DESCRIPTION	ACABAMENTO FINISHING	CAIXA BOX	REFERÊNCIA REFERENCE
01	GAVETÃO MÉDIO INTERIOR E2R BARRA FRONTAL 1100 INTERNAL PANEL 1100	<input type="radio"/> BRANCO WHITE	20 UN	G200007602
		<input type="radio"/> CINZA GREY		G200008422
03	FIXADOR FRONTAL E2R E2R COVER CAP SET	<input type="radio"/> CINZA GREY	20 UN	G200007822
01	GAVETÃO MÉDIO INTERIOR E2Q BARRA FRONTAL 1100 INTERNAL PANEL 1100	<input type="radio"/> BRANCO WHITE	20 UN	G200007602
		<input type="radio"/> CINZA GREY		G200008422
04	FIXADOR FRONTAL E2Q E2Q COVER CAP SET	<input type="radio"/> BRANCO WHITE	40 UN	G200007902
		<input type="radio"/> CINZA GREY		G200007922

GAVETÃO ALTO INTERIOR DTC E4R
DTC E4R HIGH INNER DRAWER

GAVETÃO ALTO INTERIOR DTC E4Q
DTC E4Q HIGH INNER DRAWER

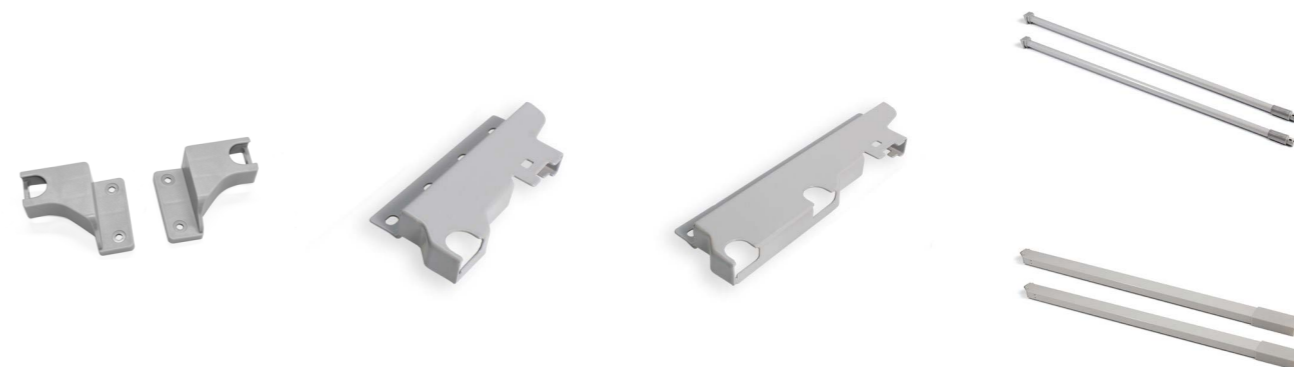

TRASEIRA ABERTA
DTC OPEN SET BACK PANEL

TRASEIRA P/GAVETÃO MÉDIO
DTC SET BACK PANEL H140

TRASEIRA P/GAVETÃO ALTO
DTC SET BACK PANEL H200

VARÕES REDONDO E RETANGULAR
DTC LATERAL RAILS ROUND AND RECTANGULAR

MODELO MODEL	DESCRIÇÃO DESCRIPTION	ACABAMENTO FINISHING	CAIXA BOX	REFERÊNCIA REFERENCE
01	BARRA FRONTAL 1100 INTERNAL PANEL 1100	BRANCO WHITE	20 UN	G200007602
		CINZA GREY		G200008422
05	GAVETÃO ALTO INTERIOR E4R FIXADOR FRONTAL E4R E4R COVER CAP SET	CINZA GREY	20 UN	G200008022
06	VARÃO FRONTAL E4R - 1100 E4R CROSS RAIL 1100	BRANCO WHITE	120 UN	G200008802
		CINZA GREY		G200008122
01	BARRA FRONTAL 1100 INTERNAL PANEL 1100	BRANCO WHITE	20 UN	G200007602
		CINZA GREY		G200008422
07	GAVETÃO ALTO INTERIOR E4Q FIXADOR FRONTAL E4Q E4Q COVER CAP SET	BRANCO WHITE	20 UN	G200010002
		CINZA GREY		G200010022
08	VARÃO FRONTAL E4Q - 1100 E4Q CROSS RAIL 1100	BRANCO WHITE	60 UN	G200010102
		CINZA GREY		G200010122

MODELO MODEL	DESCRIÇÃO DESCRIPTION	ACABAMENTO FINISHING	CAIXA BOX	REFERÊNCIA REFERENCE
05	FIXADOR FRONTAL E4R E4R COVER CAP SET	CINZA GREY	20 UN	G200008022
06	GAVETÃO ALTO INTERIOR E4R COM PUXADOR VARÃO FRONTAL E4R - 1100 E4R CROSS RAIL 1100	BRANCO WHITE	120 UN	G200008802
		CINZA GREY		G200008122
-	BARRA FRONTAL 1100 INTERNAL PANEL 1100	CINZA GREY	20 UN	G200008422
-	PUXADOR PLÁSTICO INTERNAL DRAWER HANDLE	CINZA GREY	-	G200008522

MODELO MODEL	COMPRIMENTO LENGTH	ACABAMENTO FINISHING	CAIXA BOX	REFERÊNCIA REFERENCE
TRASEIRA ABERTA P/GAVETA E1	-	CINZA GREY	200 UN	G200009722
TRASEIRA P/ GAVETÃO MÉDIO E2 H141	-	BRANCO WHITE	20 UN	G200009402
		CINZA GREY		G200009422
TRASEIRA P/ GAVETÃO ALTO E4.2 H204	-	BRANCO WHITE	20 UN	G200009502
		CINZA GREY		G200009522
VARÃO REDONDO P/ GAVETÃO E1	270	CINZA GREY	20 UN	G200010322
	350			G200010522
	400			G200010622
	450			G200010722
VARÃO RETANGULAR P/ GAVETÃO E1	500	BRANCO WHITE	20 UN	G200010802
	270	CINZA GREY		G200010822
		BRANCO WHITE		G200011002
	350	BRANCO WHITE		G200011202
		CINZA GREY		G200011222
	400	BRANCO WHITE		G200011302
		CINZA GREY		G200011322
	450	BRANCO WHITE		G200011402
CINZA GREY		G200011422		
500	BRANCO WHITE	G200011502		
	CINZA GREY	G200011522		



SALVA SIFÃO SIMPLE
SIMPLE PLASTIC WALL
FOR SIPHON'S SPACE

SALVA SIFÃO SQUARE
SQUARE PLASTIC WALL
FOR SIPHON'S SPACE

SALVA SIFÃO LADY
LADY PLASTIC WALL
FOR SIPHON'S SPACE

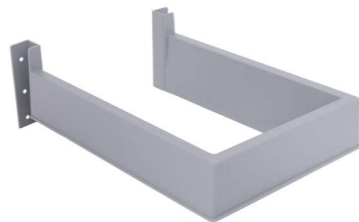

MODELO MODEL	ACABAMENTO FINISHING	CAIXA BOX	REFERÊNCIA REFERENCE
SALVA SIFÃO SIMPLE	○ BRANCO WHITE	30 UN	K520005926
	● CINZA GREY		K520005922
	● ANTRACITE ANTHRACITE		K520005924
SALVA SIFÃO SQUARE	○ BRANCO WHITE	38 UN	K520013026
	● CINZA GREY		K520013022
	● ANTRACITE ANTHRACITE		K520013024
SALVA SIFÃO LADY	○ BRANCO WHITE	10 UN	K520022626
	● CINZA GREY		K520022622
	● ANTRACITE ANTHRACITE		K520022624

ULTRABOX
ULTRABOX



MODELO MODEL	COMPRIMENTO LENGHT	ACABAMENTO FINISHING	PESO WEIGHT	CAIXA BOX	REFERÊNCIA REFERENCE			
ULTRABOX H86	270	○ BRANCO WHITE	25 KG	10 UN	G210004402			
		● CINZA GREY			G210004422			
	350	○ BRANCO WHITE			G210004502			
		● CINZA GREY			G210004522			
	400	○ BRANCO WHITE			G210004602			
		● CINZA GREY			G210004622			
	450	○ BRANCO WHITE			G210004702			
		● CINZA GREY			G210004722			
	500	○ BRANCO WHITE			G210004802			
		● CINZA GREY			G210004822			
	ULTRABOX H118	350			○ BRANCO WHITE	25 KG	10 UN	G210005002
					● CINZA GREY			G210005022
400		○ BRANCO WHITE	G210005102					
		● CINZA GREY	G210005122					
450		○ BRANCO WHITE	G210005202					
		● CINZA GREY	G210005222					
500		○ BRANCO WHITE	G210005302					
		● CINZA GREY	G210005322					
ULTRABOX H150		350	○ BRANCO WHITE	25 KG	10 UN			G210005402
			● CINZA GREY					G210005422
		400	○ BRANCO WHITE					G210005502
			● CINZA GREY					G210005522
	450	○ BRANCO WHITE	G210005602					
		● CINZA GREY	G210005622					
500	○ BRANCO WHITE	G210005702						
	● CINZA GREY	G210005722						

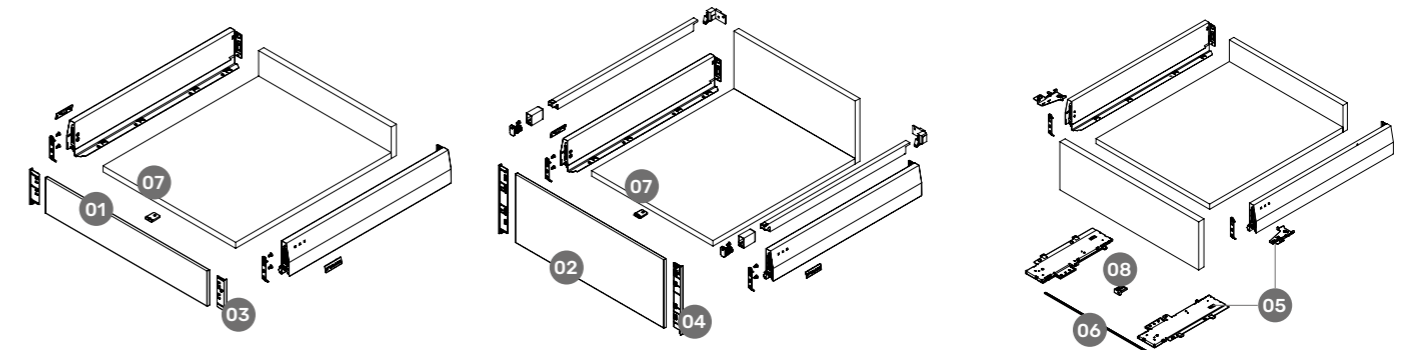

MODELO MODEL	DESCRIÇÃO DESCRIPTION	ACABAMENTO FINISHING	CAIXA BOX	REFERÊNCIA REFERENCE
GAVETA INTERIOR NOVA PRO ONE	01 PERFIL INTERIOR F8 H.90 F8 INSET PANEL H.90	○ BRANCO WHITE	20 UN	F 1021 0535 7211
		● CINZA GREY		F 1021 0506 9211
		● ANTRACITE ANTHRACITE		F 1021 0137 1211
H.90	03 TAMPA P/PERFIL INTERIOR F8 H.90 F8 COVER CAP, INSET PANEL H.90	○ BRANCO WHITE	60 UN	F 1021 0535 9218
		● CINZA GREY		F 1021 0957 2218
		● ANTRACITE ANTHRACITE		F 1021 0138 4218
	07 UNIÃO/CONECTOR FRENTE-FUNDO INT. F8 FRONT-BOTTOM CONNECTOR	-	01 UN	F 1451 1799 3223
GAVETA INTERIOR NOVA PRO ONE	02 PERFIL INTERIOR F8 H.186 F8 INSET PANEL H.186	○ BRANCO WHITE	10 UN	F 1021 0535 8207
		● CINZA GREY		F 1021 0507 0207
		● ANTRACITE ANTHRACITE		F 1021 0137 9207
H.186	04 TAMPA P/PERFIL INTERIOR F8 H.186 F8 COVER CAP, INSET PANEL H.186	○ BRANCO WHITE	30 UN	F 1021 0536 0214
		● CINZA GREY		F 1021 0957 3214
		● ANTRACITE ANTHRACITE		F 1021 0145 1214
	07 UNIÃO/CONECTOR FRENTE-FUNDO INT. F8 FRONT-BOTTOM CONNECTOR	-	01 UN	F 1451 1799 3223
TMSC NOVA PRO ONE	05 GRASS NP ONE SET TMSC UNIDADE ATIVADOR NOVA PRO TIPMATIC SOFT-CLOSE UNIT	-		F 1021 3370 6607
	06 GRASS NP ONE BARRA TMSC 1200/16 SINCRONIZADO NOVA PRO SYNCHRONISATION ROD TMSC 1200	-	01 UN	F 1021 0939 3207
	08 GRASS NP ONE SUPORTE P/ BARRA SINCRONIZADO NOVA PRO SUPPORT FOR SYNCHRONISATION ROD	-		F 1021 0802 1223
VARÃO ICE	300			F 1021 0352 6507
	350			F 1021 0352 7507
	400	○ BRANCO WHITE	10 UN	F 1021 0352 8507
VARÃO SILVER	450			F 1021 0352 9507
	500			F 1021 0353 0507
	300			F 1021 0353 5507
VARÃO STONE	350			F 1021 0353 6507
	400	● CINZA GREY	10 UN	F 1021 0353 7507
	450			F 1021 0353 8507
VARÃO STONE	500			F 1021 0353 9507
	300			F 1021 0351 7507
	350			F 1021 0351 8507
VARÃO STONE	400	● ANTRACITE ANTHRACITE	10 UN	F 1021 0351 9507
	450			F 1021 0352 0507
	500			F 1021 0352 1507

MODELO MODEL	COMPRIMENTO LENGTH	ACABAMENTO FINISHING	PESO WEIGHT	CAIXA BOX	REFERÊNCIA REFERENCE
NOVA PRO ONE ICE	300	○ BRANCO WHITE	40 KG	01 UN	F 1001 3367 0201
	350				F 1001 3367 1201
	400				F 1001 3367 2201
	450				F 1001 3367 3201
	500				F 1001 3367 4201
NOVA PRO ONE SILVER	300	● CINZA GREY	40 KG	01 UN	F 1001 3408 6201
	350				F 1001 3408 7201
	400				F 1001 3408 8201
	450				F 1001 3408 9201
	500				F 1001 3409 0201
NOVA PRO ONE STONE	300	● ANTRACITE ANTHRACITE	40 KG	01 UN	F 1001 3367 8201
	350				F 1001 3367 9201
	400				F 1001 3368 0201
	450				F 1001 3368 1201
	500				F 1001 3368 2201
CORREDIÇA DIREITA	500	-	70 KG	01 UN	F 1011 0829 0211
CORREDIÇA ESQUEDA					F 1011 0828 9211



DYNAPRO

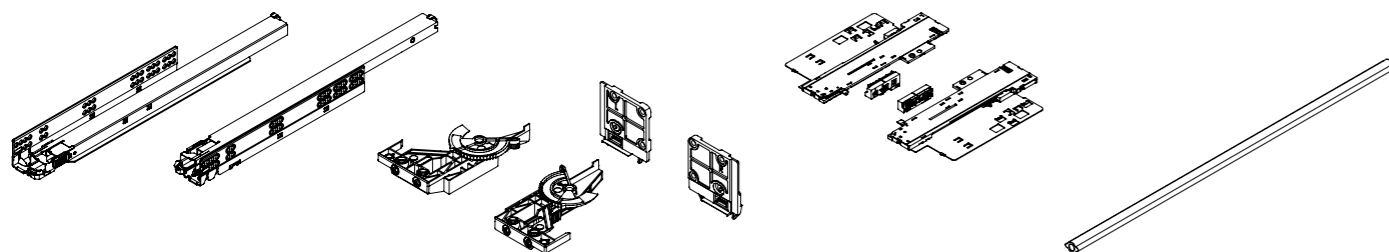

01 02 03 04

MODELO MODEL	DESCRIÇÃO DESCRIPTION	CAIXA BOX	REFERÊNCIA REFERENCE
01	DYNAPRO TMSC SET 40KG - 350MM	01 UN	F 1301 0780 2604
	DYNAPRO TMSC SET 40KG - 400MM		F 1301 0780 8604
	DYNAPRO TMSC SET 40KG - 450MM		F 1301 0781 4604
	DYNAPRO TMSC SET 40KG - 500MM		F 1301 0782 0604
	DYNAPRO TMSC SET 40KG - 550MM		F 1301 0782 6604
	DYNAPRO TMSC SET 40KG - 600MM		F 1301 0785 0604
	DYNAPRO TMSC SET 70KG - 600MM		F 1301 0785 0604
02	DYNAPRO TMSC SET 70KG - 650MM	01 UN	F 1301 0782 9604
	DYNAPRO TMSC SET 70KG - 700MM		F 1301 0785 6604
	DYNAPRO TMSC SET 70KG - 750MM		F 1301 0785 9604
03	DYNAPRO SET REGULAÇÃO 3D DYNAPRO 3D SET	01 UN	F 1341 0895 6517
04	DYNAPRO SET TMSC UNIDADE ATIVADOR DYNAPRO TIPMATIC SOFT-CLOSE UNIT	01 UN	F 1341 0932 3607
04	DYNAPRO BARRA TMSC 1200/16 SINCRO SYNCHRONISATION ROD 1200	01 UN	F 1341 0941 0207
	DYNAPRO BM TMSC 40KG - 450MM		F 1301 0788 4604
	DYNAPRO BM TMSC 40KG - 500MM		F 1301 0789 0604
-	DYNAPRO BM TMSC 40KG - 550MM	01 UN	F 1301 0789 3604
	DYNAPRO BM TMSC 40KG - 550MM		F 1301 0789 3604
-	1D LOCKING DEVICE SET REGULAÇÃO 1D DYNAMOOV 1D FRONT LOCKING DEVICE (SET)	01 UN	F 1341 0122 0517

CORREDIÇA A27
A27 BALL BEARING SLIDE

CORREDIÇA A35
A35 BALL BEARING SLIDE

CORREDIÇA A45
A45 BALL BEARING SLIDE



MODELO MODEL	COMPRIMENTO LENGTH	PESO WEIGHT	CAIXA BOX	REFERÊNCIA REFERENCE
CORREDIÇA A27	480	25 KG	30 UN	G210000120
	250			G210000220
	300			G210000320
	350			G210000420
CORREDIÇA A35	400	30 KG	20 UN	G210000520
	450			G210000620
	500			G210000720
	550			G210000820
	600			G210000920
	250			G210001020
	300			G210001120
350	G210001220			
CORREDIÇA A45	400	30 KG	15 UN	G210001320
	450			G210001420
	500			G210001520
	550			G210001620
	600			G210001720
	650			G210001820
	700			G210001920
CORREDIÇA A45 C/ AMORTECEDOR	250	30 KG	15 UN	G210002020
	300			G210002120
	350			G210002220
	400			G210002320
	450			G210002420
	500			G210002520
CORREDIÇA A45 TIC-TAC	550	30 KG	15 UN	G210002620
	600			G210002720
	250			G210002820
	300			G210002920
	350			G210003020
	400			G210003120
CORREDIÇA A45 TIC-TAC	450	30 KG	15 UN	G210003220
	500			G210003320
	550			G210003420
	550			G210003420

CATÁLOGO GERAL • GENERAL CATALOGUE

CATÁLOGO GERAL • GENERAL CATALOGUE

CORREDIÇAS

SLIDES

CORREDIÇA A53

A53 BALL BEARING SLIDE



MODELO MODEL	COMPRIMENTO LENGHT	PESO WEIGHT	CAIXA BOX	REFERÊNCIA REFERENCE
CONJUNTO CORREDIÇAS A53	700	120 KG	06 UN	G210003620
	800			G210003720
	900			G210003820
	1000			G210003920
	1100			G210004020
	1200			G210004120
	1300		04 UN	G210004220

CORREDIÇAS ECO-B



AMORTECEDOR

SOFT CLOSING SYSTEM



MODELO MODEL	COMPRIMENTO LENGHT	ACABAMENTO FINISHING	PESO WEIGHT	CAIXA BOX	REFERÊNCIA REFERENCE			
CORREDIÇAS ECO-B	300	BRANCO WHITE	25 KG	25 UN	G210016102			
	350				G210016202			
	400				G210016302			
	450				G210016402			
	500				G210016502			
	350				CINZA GREY	25 KG	24 UN	G210006222
	400	G210006322						
	450	G210006422						
	500	G210006522						
	300	CASTANHO BROWN	25 KG	25 UN				G210016127
	350							G210016227
	400				G210016327			
450	G210016427							
500	G210016527							
AMORTECEDOR	PARA GAVETA FOR DARWER	-	25 KG	100 UN	G210006922			

Blank.

UNDERMOUNTED SLIDES

AMORTECEDOR, EXTRAÇÃO PARCIAL

SOFT CLOSE, SINGLE EXTENSION

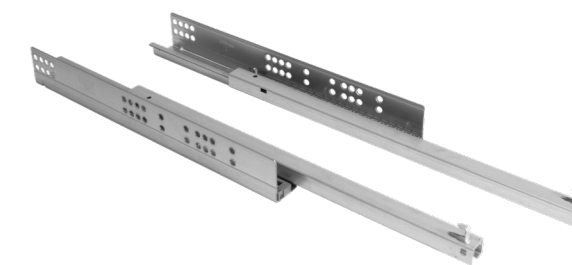

MODELO MODEL	COMPRIMENTO LENGHT	PESO WEIGHT	CAIXA BOX	REFERÊNCIA REFERENCE
CORREDIÇA OCULTA BLANK	250	25 KG	10 UN	G210015920
	300			G210016020
	350			G210016120
	400			G210016220
	450			G210016320
	500			G210016420
	550			G210016520

! COM AMORTECEDOR, EXTRAÇÃO PARCIAL
SOFT CLOSE, SINGLE EXTENSION

AMORTECEDOR, EXTRAÇÃO TOTAL

SOFT CLOSE, FULL EXTENSION

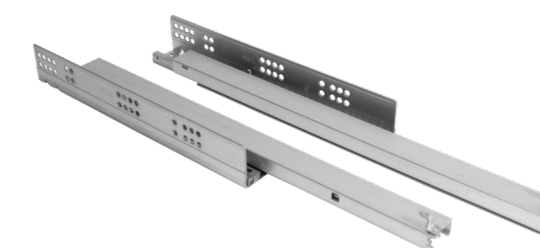

MODELO MODEL	COMPRIMENTO LENGHT	PESO WEIGHT	CAIXA BOX	REFERÊNCIA REFERENCE
CORREDIÇA OCULTA BLANK	250	30 KG	10 UN	G210016720
	300			G210016820
	350			G210016920
	400			G210017020
	450			G210017120
	500			G210017220
	550			G210017320

! COM AMORTECEDOR, EXTRAÇÃO TOTAL
SOFT CLOSE, FULL EXTENSION

TIC TAC, EXTRAÇÃO PARCIAL
PUSH TO OPEN, SINGLE EXTENSION



MODELO MODEL	COMPRIMENTO LENGHT	PESO WEIGHT	CAIXA BOX	REFERÊNCIA REFERENCE
CORREDIÇA OCULTA TIC TAC BLANK	250	25 KG	10 UN	G210024020
	300			G210024120
	350			G210024220
	400			G210024320
	450			G210024420
	500			G210024520

! TIC TAC, EXTRAÇÃO PARCIAL
PUSH TO OPEN, SINGLE EXTENSION

TIC TAC, EXTRAÇÃO TOTAL
PUSH TO OPEN, FULL EXTENSION



MODELO MODEL	COMPRIMENTO LENGHT	PESO WEIGHT	CAIXA BOX	REFERÊNCIA REFERENCE
CORREDIÇA OCULTA TIC TAC BLANK	250	30 KG	10 UN	G210024820
	300			G210024920
	350			G210025020
	400			G210025120
	450			G210025220
	500			G210025320

! TIC TAC, EXTRAÇÃO TOTAL
PUSH TO OPEN, FULL EXTENSION

CORREDIÇA MESA TSU
TSU TABLE SLIDE



MODELO MODEL	COMPRIMENTO LENGHT	CAIXA BOX	REFERÊNCIA REFERENCE
CORREDIÇA MESA TSU	47X1050	01 UN	G210020520

CORREDIÇA MESA TS1
TS1 TABLE SLIDE

CORREDIÇA MESA TSB2
TSB2 TABLE SLIDE

CORREDIÇA MESA TS2
TS2 TABLE SLIDE



MODELO MODEL	COMPRIMENTO LENGHT	CAIXA BOX	REFERÊNCIA REFERENCE
CORREDIÇA MESA TS1	47X770	01 UN	G210022020
	47X850		G210021020
	47X1000		G210021120
CORREDIÇA MESA TSB2 C/TRAVÃO	47X1150	01 UN	G210021220
	47X1250		G210021320
	47X1350		G210021420
	47X1450		G210021520
	CORREDIÇA MESA TS2 S/TRAVÃO		47X1700

08

DOBRADIÇAS
HINGES

138 DOBRADIÇAS FB
FB HINGES

142 DOBRADIÇAS IN
IN HINGES

144 DOBRADIÇAS DTC
DTC HINGES

147 DOBRADIÇA KIMANA
KIMANA HINGE

147 DOBRADIÇA GRASS
GRASS HINGE

DOBRADIÇA EE
EE HINGE

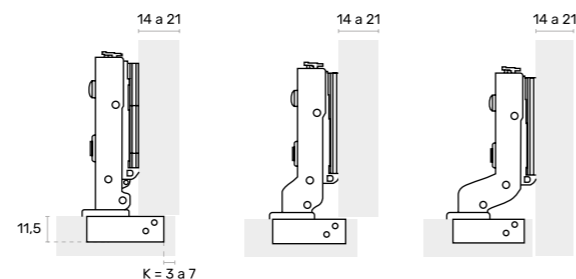

MODELO MODEL	ESPESSURA DA PLACA DOOR THICKNESS	ÂNGULO ANGLE	DIÂMETRO DIAMETER	CAIXA BOX	REFERÊNCIA REFERENCE	
DOBRADIÇA EE	C=0	14-21	105°	Ø35	100 UN	D100000120
	C=8					D100000220
	C=15					D100000320

i COM AMORTECEDOR
SOFT CLOSE

DOBRADIÇA TT
TT HINGE

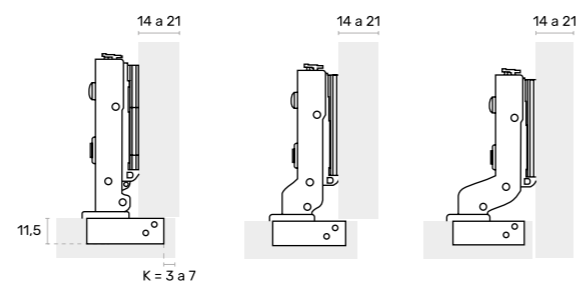

MODELO MODEL	ESPESSURA DA PLACA DOOR THICKNESS	ÂNGULO ANGLE	DIÂMETRO DIAMETER	CAIXA BOX	REFERÊNCIA REFERENCE	
DOBRADIÇA TT	C=0	14-21	105°	Ø35	100 UN	D100000420
	C=8					D100000520
	C=15					D100000620

i COM AMORTECEDOR 3D
3D SOFT CLOSE

DOBRADIÇA TT 2W	C=0	14-21	105°	Ø35	100 UN	D100000720
	C=8					D100000820
	C=15					D100000920

i 2 POSIÇÕES COM AMORTECEDOR 3D
2 WAY 3D SOFT CLOSE

DOBRADIÇA TTBC
TTBC HINGE

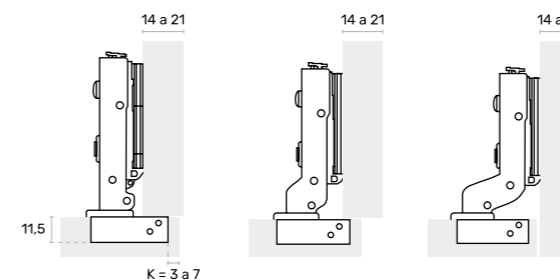

MODELO MODEL	ESPESSURA DA PLACA DOOR THICKNESS	ÂNGULO ANGLE	DIÂMETRO DIAMETER	CAIXA BOX	REFERÊNCIA REFERENCE	
DOBRADIÇA TTBC	C=0	14-21	105°	Ø35	100 UN	D100001320
	C=8					D100001420
	C=15					D100001520

i COM AMORTECEDOR 3D
3D SOFT CLOSE

DOBRADIÇA TTBC 2W	C=0	14-21	105°	Ø35	100 UN	D100001620
	C=8					D100001720
	C=15					D100001820

i 2 POSIÇÕES COM AMORTECEDOR 3D
2 WAY 3D SOFT CLOSE

DOBRADIÇA TTMD
TTMD HINGE

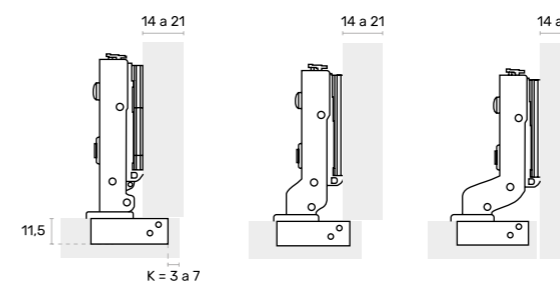

MODELO MODEL	ESPESSURA DA PLACA DOOR THICKNESS	ÂNGULO ANGLE	DIÂMETRO DIAMETER	CAIXA BOX	REFERÊNCIA REFERENCE	
DOBRADIÇA TTMD	C=0	14-21	105°	Ø35	200 UN	D100010420
	C=8					D100010520
	C=15					D100010620

i COM AMORTECEDOR 3D
3D SOFT CLOSE

DOBRADIÇA TTMD 2W	C=0	14-21	105°	Ø35	200 UN	D100011420
	C=8					D100011520
	C=15					D100011620

i 2 POSIÇÕES COM AMORTECEDOR 3D
2 WAY 3D SOFT CLOSE

DOBRADIÇAS FB

FB HINGES

DOBRADIÇAS FB

FB HINGES

DOBRADIÇA 25°

25° HINGE

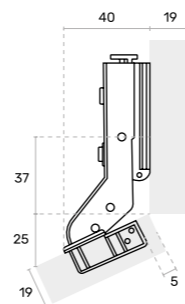

MODELO MODEL	ÂNGULO ANGLE	ESPESSURA DA PLACA DOOR THICKNESS	DIÂMETRO DIAMETER	CAIXA BOX	REFERÊNCIA REFERENCE
DOBRADIÇA 25°	25°	14-21	Ø35	100 UN	D100001920

i COM AMORTECEDOR
SOFT CLOSE

DOBRADIÇA 30° 3D

30° 3D HINGE

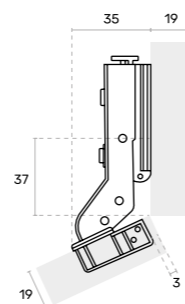

MODELO MODEL	ESPESSURA DA PLACA DOOR THICKNESS	ÂNGULO ANGLE	DIÂMETRO DIAMETER	CAIXA BOX	REFERÊNCIA REFERENCE
DOBRADIÇA 30°	14-21	30°	Ø35	100 UN	D100010820

i COM AMORTECEDOR
SOFT CLOSE

DOBRADIÇA 45°

45° HINGE

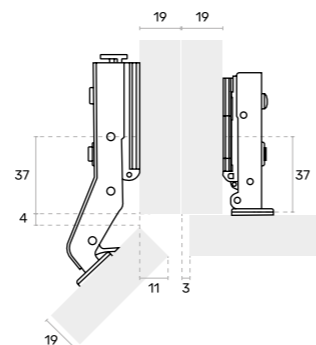

MODELO MODEL	ESPESSURA DA PLACA DOOR THICKNESS	ÂNGULO ANGLE	DIÂMETRO DIAMETER	CAIXA BOX	REFERÊNCIA REFERENCE
DOBRADIÇA 45°	14-21	45°	Ø35	100 UN	D100002120

i COM AMORTECEDOR
SOFT CLOSE

DOBRADIÇA 90°

90° HINGE

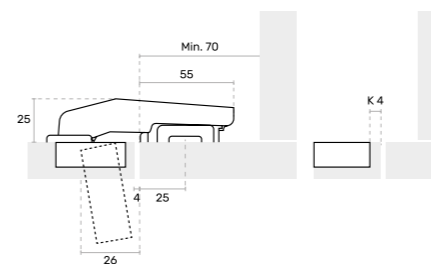

MODELO MODEL	ESPESSURA DA PLACA DOOR THICKNESS	ÂNGULO ANGLE	DIÂMETRO DIAMETER	CAIXA BOX	REFERÊNCIA REFERENCE
DOBRADIÇA 90°	14-21	90°	Ø35	100 UN	D100002220

i COM AMORTECEDOR
SOFT CLOSE

DOBRADIÇA 165°

165° HINGE

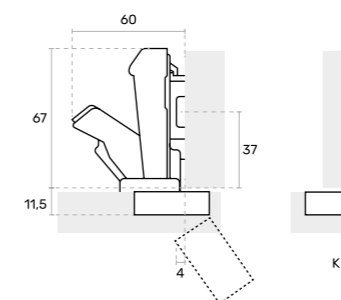

MODELO MODEL	ESPESSURA DA PLACA DOOR THICKNESS	ÂNGULO ANGLE	DIÂMETRO DIAMETER	CAIXA BOX	REFERÊNCIA REFERENCE
DOBRADIÇA 165° 3D	C=0				D100011120
DOBRADIÇA 165°	C=8	14-21	165°	Ø35	100 UN
	C=15				D100002520

i COM AMORTECEDOR
SOFT CLOSE

DOBRADIÇA MINI

MINI HINGE

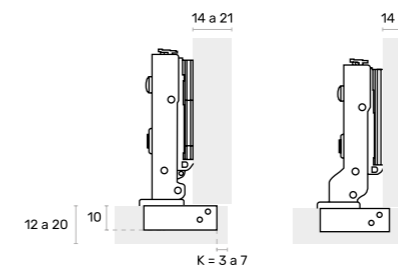

MODELO MODEL	ESPESSURA DA PLACA DOOR THICKNESS	ÂNGULO ANGLE	DIÂMETRO DIAMETER	CAIXA BOX	REFERÊNCIA REFERENCE
DOBRADIÇA MINI	C=0	14-21	95°	Ø26	100 UN
	C=8				D100002720

i COM AMORTECEDOR
SOFT CLOSE

DOBRADIÇA NH-D
NH-D HINGE

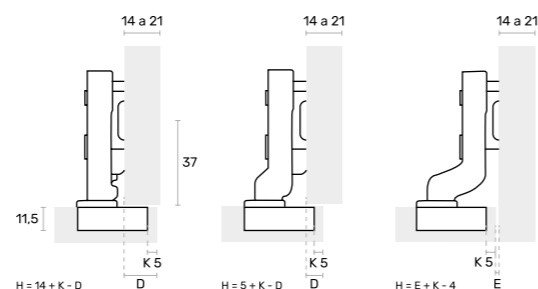

MODELO MODEL	ESPESSURA DA PLACA DOOR THICKNESS	ÂNGULO ANGLE	DIÂMETRO DIAMETER	CAIXA BOX	REFERÊNCIA REFERENCE
	C=0				D100009220
DOBRADIÇA NH-D	C=8	14-21	110°	200 UN	D100009320
	C=15				D100009420

i SIMPLES
SLIDE ON

DOBRADIÇA NH-C
NH-C HINGE

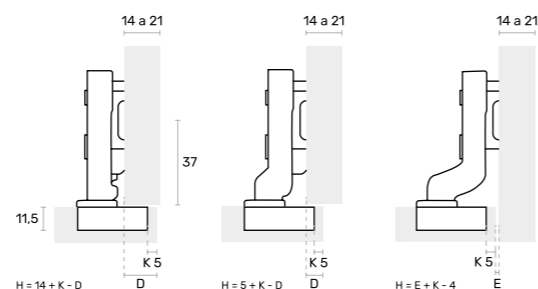

MODELO MODEL	ESPESSURA DA PLACA DOOR THICKNESS	ÂNGULO ANGLE	DIÂMETRO DIAMETER	CAIXA BOX	REFERÊNCIA REFERENCE
	C=0				D100009520
DOBRADIÇA NH-C	C=8	14-21	110°	200 UN	D100009620
	C=15				D100009720

i COM CLIP
WITH CLIP

DOBRADIÇA 102-135
102-135 HINGE

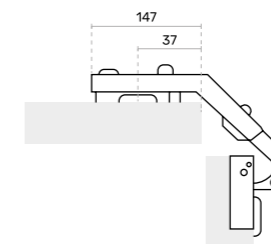

MODELO MODEL	ESPESSURA DA PLACA DOOR THICKNESS	ÂNGULO ANGLE	DIÂMETRO DIAMETER	CAIXA BOX	REFERÊNCIA REFERENCE
DOBRADIÇA 102-135	C=0	14-21	135°	100 UN	D100004020

i SIMPLES
SLIDE ON

DOBRADIÇA 102-165
102-165 HINGE

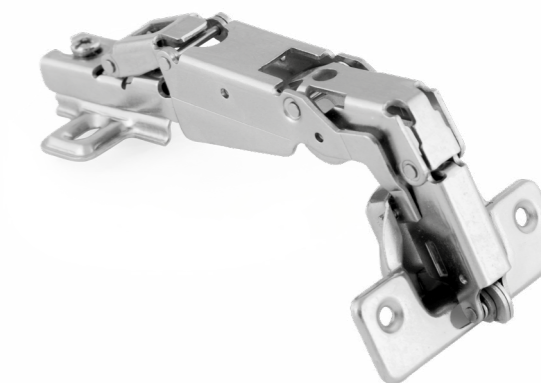
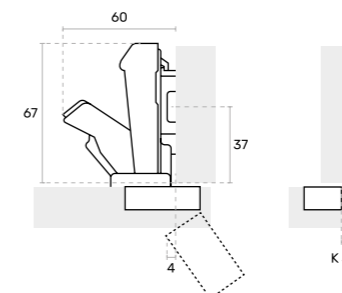

MODELO MODEL	ESPESSURA DA PLACA DOOR THICKNESS	ÂNGULO ANGLE	DIÂMETRO DIAMETER	CAIXA BOX	REFERÊNCIA REFERENCE
DOBRADIÇA 102-165	C=0	14-21	165°	100 UN	D100004120

i SIMPLES
SLIDE ON

DOBRADIÇA 102-BC2
102-BC2 HINGE

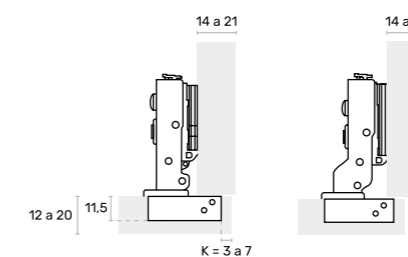

MODELO MODEL	ESPESSURA DA PLACA DOOR THICKNESS	ÂNGULO ANGLE	DIÂMETRO DIAMETER	CAIXA BOX	REFERÊNCIA REFERENCE
DOBRADIÇA 102-BC2	C=0	14-21	110°	200 UN	D100004520
	C=8				D100004420

i SIMPLES
SLIDE ON

DTC AMORTECEDOR 3D
SOFT CLOSING 3D DTC HINGE



MODELO MODEL	ESPESSURA DA PLACA DOOR THICKNESS	ÂNGULO ANGLE	DIÂMETRO DIAMETER	CAIXA BOX	REFERÊNCIA REFERENCE	
DTC AMORTECEDOR 3D	C=0				D100007420	
	C=8	14-21	110°	Ø35	200 UN	D100007520
	C=15					D100007620
DTC AMORTECEDOR 3D 2W	C=0	14-21	110°	Ø35	250 UN	D1Q02Q2920
CALÇO	H=0					D100007720
	H=2	14-21	-	Ø35	200 UN	D100007820

DTC MOLA INVERTIDA
REVERSE SPRING DTC HINGE



DTC SEM MOLA
DTC HINGE WITHOUT SPRING



MODELO MODEL	ESPESSURA DA PLACA DOOR THICKNESS	ÂNGULO ANGLE	DIÂMETRO DIAMETER	CAIXA BOX	REFERÊNCIA REFERENCE	
DTC MOLA INVERTIDA	C=0				D100006220	
	C=8	14-21	110°	Ø35	250 UN	D100006320
	C=15					D100006420
DTC SEM MOLA	C=0				D100006520	
	C=8	14-21	110°	Ø35	250 UN	D100006620
	C=15					D100006720

DTC SIMPLES
SLIDE ON DTC HINGE



DTC CLIP
CLIP ON DTC HINGE



MODELO MODEL	ESPESSURA DA PLACA DOOR THICKNESS	ÂNGULO ANGLE	DIÂMETRO DIAMETER	CAIXA BOX	REFERÊNCIA REFERENCE	
DTC SIMPLES	C=0				D100005620	
	C=8	14-21	110°	Ø35	200 UN	D100005720
	C=15					D100005820
DTC CLIP	C=0				D100005920	
	C=8	14-21	110°	Ø35	250 UN	D100006020
	C=15					D100006120
DTC CLIP C/CALÇO 3D	C=0				D100007120	
	C=8	14-21	110°	Ø35	250 UN	D100007220
	C=15					D100007320

DTC BC
BC HINGE



DTC 90°
90° DTC HINGE



MODELO MODEL	ESPESSURA DA PLACA DOOR THICKNESS	ÂNGULO ANGLE	DIÂMETRO DIAMETER	CAIXA BOX	REFERÊNCIA REFERENCE	
DTC BC	C=0				D100008020	
	C=8	14-21	110°	Ø35	500 UN	D100008120
DTC 90°	C=0	14-21	90°	Ø35	250 UN	D100008620

DOBRADIÇAS DTC

DTC HINGES

DTC 165°
165° HINGE



DTC COPO 40MM
40MM CUP DTC HINGE



MODELO MODEL		ESPESSURA DA PLACA DOOR THICKNESS	ÂNGULO ANGLE	DIÂMETRO DIAMETER	CAIXA BOX	REFERÊNCIA REFERENCE
DTC 165°	C=0	14-21	165°	Ø35	100 UN	D100010020
	C=0					D100006820
DTC COPO 40MM	C=8	14-21	110°	Ø40	250 UN	D100006920
	C=15					D100007020
	<i>i</i> SIMPLES SLIDE ON					
DTC COPO 40MM AMORTECEDOR 3D 2W	C=0					D1Q0211020
	C=8	14-21	95°	Ø40	250 UN	D1Q0211120
	C=15					D1Q0211220

DOB.R.DTC3D
DOB.R.DTC3D



i COM CLIP
WITH CLIP

MODELO MODEL		ESPESSURA DA PLACA DOOR THICKNESS	ÂNGULO ANGLE	DIÂMETRO DIAMETER	CAIXA BOX	REFERÊNCIA REFERENCE
DTC 165°	C=0	14-21	110°	Ø35	250 UN	DOB.R.DTC3D

ITALIANA
ferramenta

DOBRADIÇA KIMANA

KIMANA HINGE



MODELO MODEL	ACABAMENTO FINISHING	DIÂMETRO DIAMETER	CAIXA BOX	REFERÊNCIA REFERENCE
KIMANA	● GRAFITE GRAPHITE	-	150 UN	40120010HX
PARAFUSOS	● GRAFITE GRAPHITE	3,5x16	-	60101390HX

G*GRASS

DOBRADIÇA GRASS

GRASS HINGE



MODELO MODEL		ESPESSURA DA PLACA DOOR THICKNESS	ÂNGULO ANGLE	DIÂMETRO DIAMETER	CAIXA BOX	REFERÊNCIA REFERENCE
TIOMOS	C=0	14-21	110°	Ø35	150 UN	D110000120
	C=8					D110000320
CALÇO TIOMOS						D120000120

09

PERFIS
DE ALUMÍNIO
PARA COZINHA
E ROUPEIROS
KITCHEN
AND WARDROBE
PROFILES

150 PERFIS PARA COZINHA
KITCHEN PROFILES

164 PERFIS PARA ROUPEIRO
WARDROBE PROFILES

177 KIT SPACE
KIT SPACE

178 OUTROS PERFIS
OTHER PROFILES

PERFIS PARA COZINHA

KITCHEN PROFILES

PERFIS PARA COZINHA

KITCHEN PROFILES

PERFIL C

C PROFILE

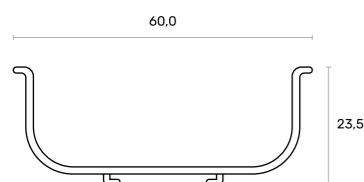

PERFIL J

J PROFILE

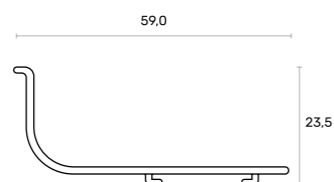

PERFIL JB

JB PROFILE



ACESSÓRIOS

ACCESSORIES



ESQUADRO OMEGA

OMEGA CONNECTOR

PARA PERFIL C, J E JB
FOR C, J AND JB PROFILE

TERMINAL J

J TERMINAL

TERMINAL C

C TERMINAL

MODELO MODEL	ACABAMENTO FINISHING	COMPRIMENTO TOTAL TOTAL LENGTH	CAIXA BOX	REFERÊNCIA REFERENCE
PERFIL C	BRANCO MATE MATT WHITE	5000	10 UN	K505000103
	BRANCO BRILHO BRIGHT WHITE			K505000102
	ANODIZADO ANODIZED			K505000101
	INOX MATE MATT CHAMPAGNE ANODIZED			K505000111
	OURO MATE MATT GOLD COLOURED			K505000134
	PRETO MATE MATT BLACK			K505000109
	PRETO BRILHO BRIGHT BLACK			K505000108
PERFIL J	BRANCO MATE MATT WHITE	5000	10 UN	K505000203
	BRANCO BRILHO BRIGHT WHITE			K505000202
	ANODIZADO ANODIZED			K505000201
	INOX MATE MATT CHAMPAGNE ANODIZED			K505000211
	INOX BRILHO BRIGHT CHAMPAGNE ANODIZED			K505000210
	OURO MATE MATT GOLD COLOURED			K505000234
	PRETO MATE MATT BLACK			K505000209
PRETO BRILHO BRIGHT BLACK	K505000208			
PERFIL JB	BRANCO MATE MATT WHITE	5000	10 UN	K505000303
	BRANCO BRILHO BRIGHT WHITE			K505000302
	ANODIZADO ANODIZED			K505000301
	INOX MATE MATT CHAMPAGNE ANODIZED			K505000311
	INOX BRILHO BRIGHT CHAMPAGNE ANODIZED			K505000310
	OURO MATE MATT GOLD COLOURED			K505000334
	PRETO MATE MATT BLACK			K505000309
PRETO BRILHO BRIGHT BLACK	K505000308			
ACESSÓRIOS ACCESSORIES				
ESQUADRO OMEGA		-	1000 UN	K500006020
TERMINAL J	BRANCO WHITE	ESQUERDO LEFT	01 UN	K500004603
		DIREITO RIGHT		K500004703
	ANODIZADO ANODIZED	ESQUERDO LEFT		K500004601
		DIREITO RIGHT		K500004701
	PRETO BLACK	ESQUERDO LEFT		K500004609
		DIREITO RIGHT		K500004709
TERMINAL C	BRANCO WHITE	-	01 UN	K500004803
	ANODIZADO ANODIZED			K500004801
	PRETO BLACK			K500004809

PERFIL J 8006
J 8006 PROFILE

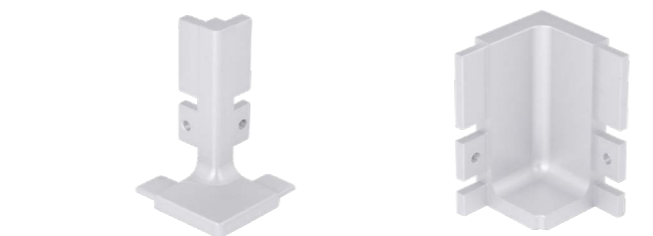
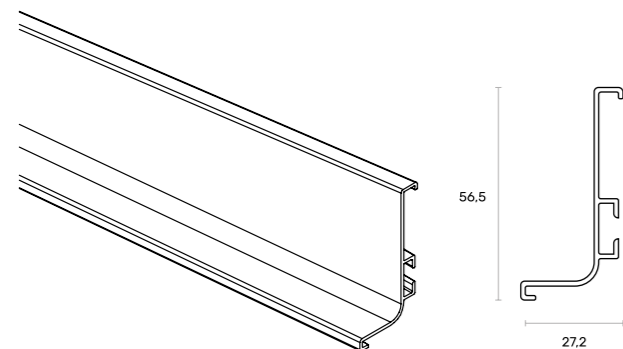

ÂNGULO 90° EXTERNO
90° EXTERNAL CORNER

ÂNGULO 90° INTERNO
90° INTERNAL CORNER



SET TERMINAIS FECHADOS
SET CLOSED TERMINALS

PERFIL C 8007
C 8007 PROFILE

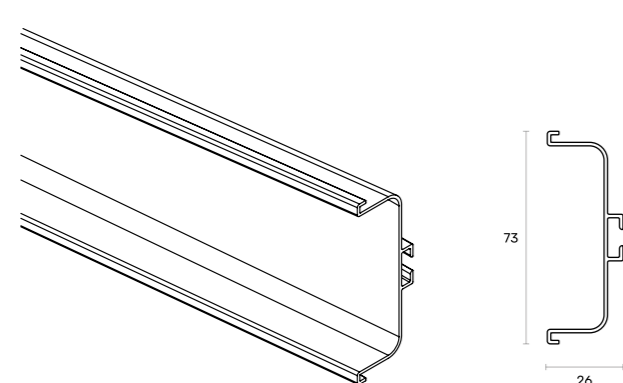

ÂNGULO 90° EXTERNO
90° EXTERNAL CORNER

ÂNGULO 90° INTERNO
90° INTERNAL CORNER



SET TERMINAIS FECHADOS
SET CLOSED TERMINALS

PERFIL JB 8070
JB 8070 PROFILE

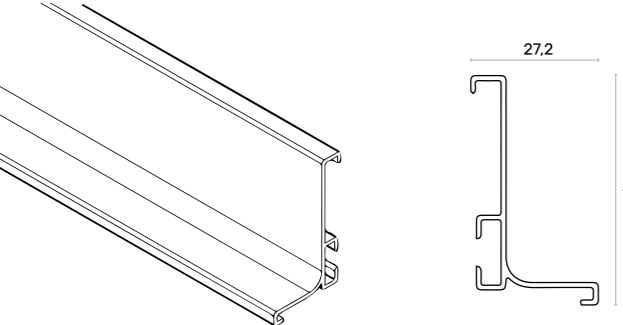

SCILM - SUPORTE UNIVERSAL GOLA
SCILM - UNIVERSAL SUPPORT

SUPORTE EASY 115 GOLA
115 EASY SUPPORT

MODELO MODEL	ACABAMENTO FINISHING	COMPRIMENTO TOTAL TOTAL LENGTH	CAIXA BOX	REFERÊNCIA REFERENCE
PERFIL J 8006	BRANCO MATE MATT WHITE	4100	25 UN	K50E800603
	ANODIZADO ANODIZED			K50E800601
	PRETO MATE MATT BLACK			K50E800609
ACESSÓRIOS ACCESSORIES				
ÂNGULO 90° EXTERNO	BRANCO MATE MATT WHITE	-	20 UN	K5SG800603
	ANODIZADO ANODIZED			K5SG800601
	PRETO MATE MATT BLACK			K5SG800609
ÂNGULO 90° INTERNO	BRANCO MATE MATT WHITE	-	20 UN	K5AG800603
	ANODIZADO ANODIZED			K5AG800601
	PRETO MATE MATT BLACK			K5AG800609
SET TERMINAIS FECHADOS	BRANCO MATE MATT WHITE	-	100 UN	K50T800603
	ANODIZADO ANODIZED			K50T800601
	PRETO MATE MATT BLACK			K50T800609
PERFIL C 8007	BRANCO MATE MATT WHITE	4100	10 UN	K50E800703
	ANODIZADO ANODIZED			K50E800701
	PRETO MATE MATT BLACK			K50E800709
ACESSÓRIOS ACCESSORIES				
ÂNGULO 90° EXTERNO	BRANCO MATE MATT WHITE	-	20 UN	K5SG800703
	ANODIZADO ANODIZED			K5SG800701
	PRETO MATE MATT BLACK			K5SG800709
ÂNGULO 90° INTERNO	BRANCO MATE MATT WHITE	-	20 UN	K5AG800703
	ANODIZADO ANODIZED			K5AG800701
	PRETO MATE MATT BLACK			K5AG800709
SET TERMINAIS FECHADOS	BRANCO MATE MATT WHITE	-	100 UN	K50T800703
	ANODIZADO ANODIZED			K50T800701
	PRETO MATE MATT BLACK			K50T800709
PERFIL JB 8070	BRANCO MATE MATT WHITE	4100	25 UN	K50E807003
	ANODIZADO ANODIZED			K50E807001
	PRETO MATE MATT BLACK			K50E807009
SCILM - SUPORTE UNIVERSAL GOLA			01 UN	K50SU11600
SUPORTE EASY 115 GOLA			01 UN	K500011530

PERFIS PARA COZINHA

KITCHEN PROFILES

PERFIL C 800
800 C PROFILE

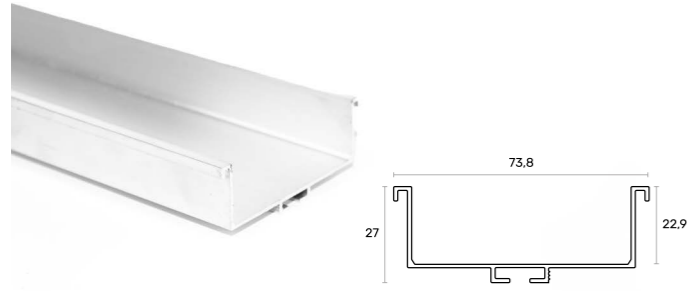

PERFIL JB 800
800 JB PROFILE



PERFIL GOLA CENTRAL 800
CENTRAL VERTICAL 800 GOLA PROFILE

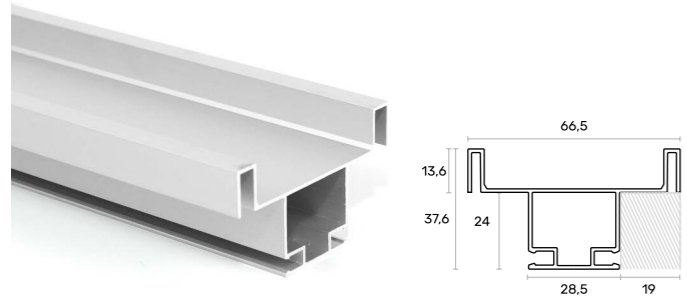

PERFIL GOLA LATERAL 800
SIDE VERTICAL 800 GOLA PROFILE

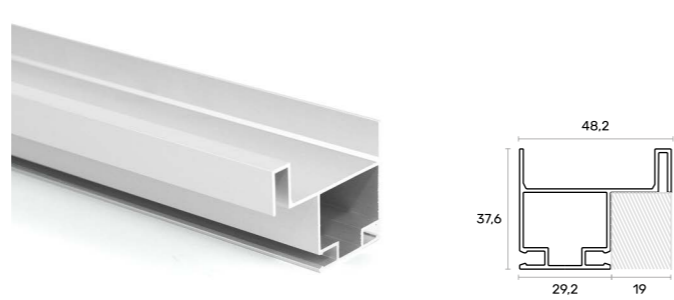

MODELO MODEL	ACABAMENTO FINISHING	COMPRIMENTO TOTAL TOTAL LENGTH	CAIXA BOX	REFERÊNCIA REFERENCE
PERFIL C 800	BRANCO MATE MATT WHITE	5000	10 UN	K505008203
	BRANCO BRILHO BRIGHT WHITE			K505008202
	ANODIZADO ANODIZED			K505008201
	OURO MATE MATT GOLD COLOURED			K505008234
	PRETO MATE MATT BLACK			K505008209
	PRETO BRILHO BRIGHT BLACK			K505008208
PERFIL JB 800	BRANCO MATE MATT WHITE	5000	10 UN	K505008303
	BRANCO BRILHO BRIGHT WHITE			K505008302
	ANODIZADO ANODIZED			K505008301
	OURO MATE MATT GOLD COLOURED			K505008334
	PRETO MATE MATT BLACK			K505008309
	PRETO BRILHO BRIGHT BLACK			K505008308
PERFIL GOLA CENTRAL 800	BRANCO MATE MATT WHITE	5000	10 UN	K505008003
	BRANCO BRILHO BRIGHT WHITE			K505008002
	ANODIZADO ANODIZED			K505008001
	OURO MATE MATT GOLD COLOURED			K505008034
	PRETO MATE MATT BLACK			K505008009
	PRETO BRILHO BRIGHT BLACK			K505008008
PERFIL GOLA LATERAL 800	BRANCO MATE MATT WHITE	5000	10 UN	K505008103
	BRANCO BRILHO BRIGHT WHITE			K505008102
	ANODIZADO ANODIZED			K505008101
	OURO MATE MATT GOLD COLOURED			K505008134
	PRETO MATE MATT BLACK			K505008109
	PRETO BRILHO BRIGHT BLACK			K505008108

PERFIL GOLA CENTRAL
CENTRAL VERTICAL GOLA PROFILE

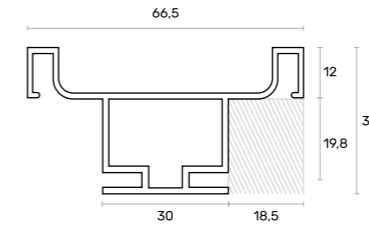
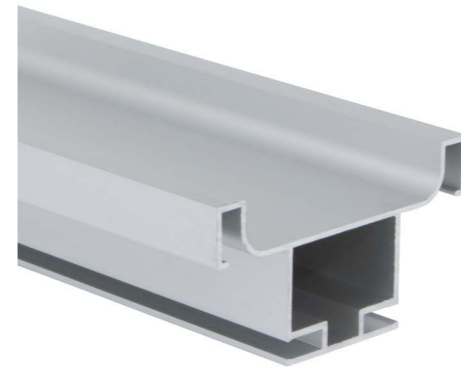

PERFIL GOLA LATERAL
SIDE VERTICAL GOLA PROFILE

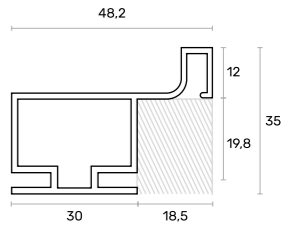

MODELO MODEL	ACABAMENTO FINISHING	COMPRIMENTO TOTAL TOTAL LENGTH	CAIXA BOX	REFERÊNCIA REFERENCE
PERFIL GOLA CENTRAL	BRANCO MATE MATT WHITE	5000	02 UN	K505000403
	BRANCO BRILHO BRIGHT WHITE			K505000402
	ANODIZADO ANODIZED			K505000401
	INOX MATE MATT CHAMPAGNE ANODIZED			K505000411
	INOX BRILHO BRIGHT CHAMPAGNE ANODIZED			K505000410
	OURO MATE MATT GOLD COLOURED			K505000434
	PRETO MATE MATT BLACK			K505000409
	PRETO BRILHO BRIGHT BLACK			K505000408
PERFIL GOLA LATERAL	BRANCO MATE MATT WHITE	5000	02 UN	K505000503
	BRANCO BRILHO BRIGHT WHITE			K505000502
	ANODIZADO ANODIZED			K505000501
	INOX MATE MATT CHAMPAGNE ANODIZED			K505000511
	INOX BRILHO BRIGHT CHAMPAGNE ANODIZED			K505000510
	OURO MATE MATT GOLD COLOURED			K505000534
	PRETO MATE MATT BLACK			K505000509
	PRETO BRILHO BRIGHT BLACK			K505000508

PERFIL GOLA CENTRAL 8032

8032 CENTRAL VERTICAL GOLA PROFILE

PERFIL GOLA LATERAL 8033

8033 SIDE VERTICAL GOLA PROFILE

PLACA
16MM

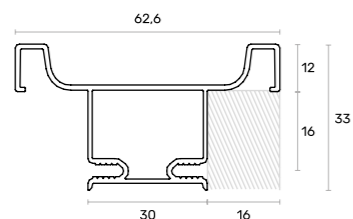

PLACA
16MM

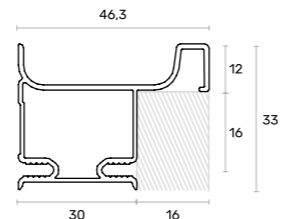

MODELO MODEL	ACABAMENTO FINISHING	COMPRIMENTO TOTAL TOTAL LENGTH	CAIXA BOX	REFERÊNCIA REFERENCE
PERFIL GOLA CENTRAL 8032	○ BRANCO MATE MATT WHITE	5000	10 UN	K505803203
	● ANODIZADO ANODIZED			K505803201
	● PRETO MATE MATT BLACK			K505803209
PERFIL GOLA LATERAL 8033	○ BRANCO MATE MATT WHITE	5000	12 UN	K505803303
	● ANODIZADO ANODIZED			K505803301
	● PRETO MATE MATT BLACK			K505803309

PERFIL GOLA R1730L

R1730L GOLA PROFILE

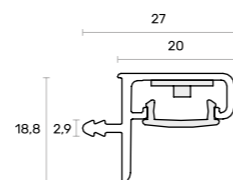

MODELO MODEL	ACABAMENTO FINISHING	COMPRIMENTO TOTAL TOTAL LENGTH	CAIXA BOX	REFERÊNCIA REFERENCE
PERFIL GOLA R1730L	● ANODIZADO ANODIZED	5000	30 UN	K50E173001

PERFIL J2
J2 PROFILE

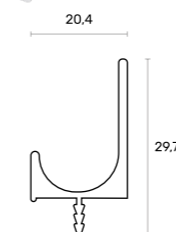

PERFIL J2Q
J2Q PROFILE

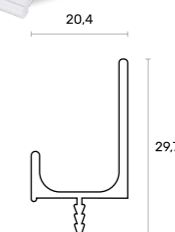

PERFIL U2
U2 PROFILE

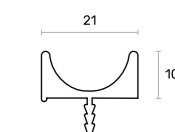

MODELO MODEL	ACABAMENTO FINISHING	COMPRIMENTO TOTAL TOTAL LENGTH	CAIXA BOX	REFERÊNCIA REFERENCE
PERFIL J2	○ BRANCO BRILHO BRIGHT WHITE	5000	10 UN	K505000602
	● ANODIZADO ANODIZED			K505000601
	● INOX MATE MATT CHAMPAGNE ANODIZED			K505000611
PERFIL J2Q	○ BRANCO BRILHO BRIGHT WHITE	5000	10 UN	K505000702
	● ANODIZADO ANODIZED			K505000701
PERFIL U2	● ANODIZADO ANODIZED	3000	10 UN	K501005601

PERFIS J3 E U3
J3 AND U3 PROFILES

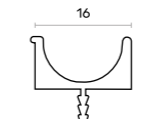
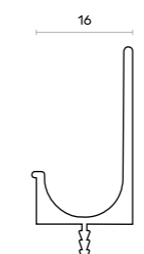

MODELO MODEL	ACABAMENTO FINISHING	COMPRIMENTO TOTAL TOTAL LENGTH	CAIXA BOX	REFERÊNCIA REFERENCE
PERFIL J3	○ BRANCO MATE MATT WHITE	5000	10 UN	K505005703
	○ BRANCO BRILHO BRIGHT WHITE			K505005702
	● ANODIZADO ANODIZED			K505005701
PERFIL U3	○ BRANCO BRILHO BRIGHT WHITE	5000	10 UN	K505005802
	● ANODIZADO ANODIZED			K505005801

PERFIS PARA COZINHA

KITCHEN PROFILES



PERFIL J3Q
J3QPROFILE

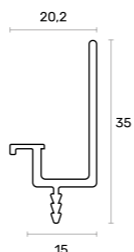

MODELO MODEL	ACABAMENTO FINISHING	COMPRIMENTO TOTAL TOTAL LENGTH	CAIXA BOX	REFERÊNCIA REFERENCE
PERFIL J3Q	○ BRANCO MATE MATT WHITE	5000	10 UN	K505005903
	○ BRANCO BRILHO BRIGHT WHITE			K505005902
	● ANODIZADO ANODIZED			K505005901
	● ANODIZADO ESCOVADO BRUSHED ANODIZED			K505005938
	● INOX MATE MATT CHAMPAGNE ANODIZED			K505005911
● OURO ESCOVADO BRUSHED GOLD			K505005937	

PERFIL 206 LED
206 LED PROFILE

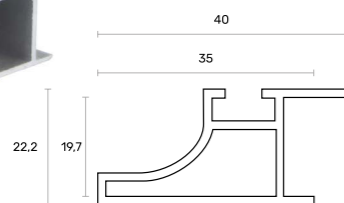

PERFIL 206B
206B PROFILE

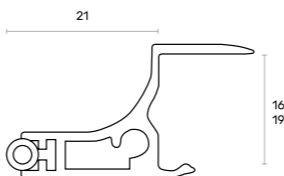

MODELO MODEL	ACABAMENTO FINISHING	COMPRIMENTO TOTAL TOTAL LENGTH	CAIXA BOX	REFERÊNCIA REFERENCE
PERFIL 206 LED	○ BRANCO MATE MATT WHITE	5000	08 UN	K505000803
	○ BRANCO BRILHO BRIGHT WHITE			K505000802
	● ANODIZADO ANODIZED			K505000801
	● INOX BRILHO BRIGHT CHAMPAGNE ANODIZED			K502000810
PERFIL 206B	● ANODIZADO ANODIZED	16X3950	20 UN	K502006501
		19X3950	10 UN	K502006601
	● PRETO MATE MATT BLACK	16X3950	20 UN	K502006509
		19X3950	10 UN	K502006609

i COM BATENTE DE BORRACHA
WITH RUBBER STOP

PERFIS PARA COZINHA

KITCHEN PROFILES

PERFIL ESTRIADO FE-17
FE-17 SINK PROFILE



SUPORTE PERFIL ESTRIADO
SINK PROFILE SUPPORT

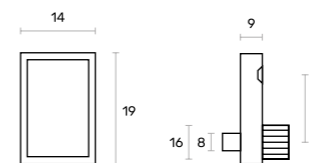

MODELO MODEL	ACABAMENTO FINISHING	COMPRIMENTO TOTAL TOTAL LENGTH	CAIXA BOX	REFERÊNCIA REFERENCE
PERFIL ESTRIADO FE-17	● ANODIZADO MATE MATT ANODIZED	5000	20 UN	K505002301
SUPORTE LATERAL		-	200 UN	K500002422

PERFIL VEDANTE 004
004 BACKSPLASH PROFILE

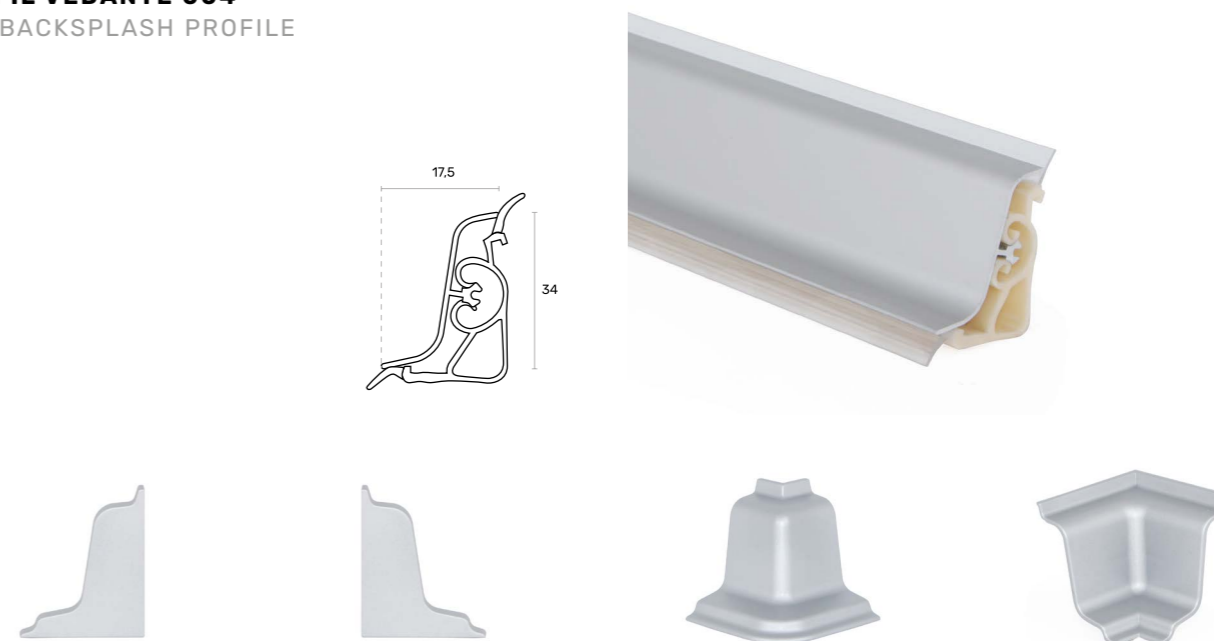

TERMINAL DIREITO 034
RIGHT FINISHING BORDER 034

TERMINAL ESQUERDO 044
LEFT FINISHING BORDER 044

UNIÃO EXTERIOR 014
OUTER BORDER 014

UNIÃO INTERIOR 024
INNER BORDER 024

MODELO MODEL	ACABAMENTO FINISHING	COMPRIMENTO TOTAL TOTAL LENGTH	CAIXA BOX	REFERÊNCIA REFERENCE
PERFIL BANCA VEDANTE 004		3950	25 UN	K502000917
TERMINAL DIREITO 034		-		K500001017
TERMINAL ESQUERDO 044	● ANODIZADO MATE MATT ANODIZED	-	50 UN	K500001117
UNIÃO EXTERIOR 014		-		K500001217
UNIÃO INTERIOR 024		-		K500001317

PERFIS PARA COZINHA

KITCHEN PROFILES



PERFIL VEDANTE 104

104 BACKSPLASH PROFILE

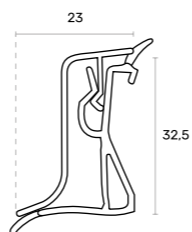

TERMINAL DIREITO 134

RIGHT FINISHING BORDER 134

TERMINAL ESQUERDO 144

LEFT FINISHING BORDER 144

UNIÃO EXTERIOR 114

OUTER BORDER 114

UNIÃO INTERIOR 124

INNER BORDER 124

MODELO MODEL	ACABAMENTO FINISHING	COMPRIMENTO TOTAL TOTAL LENGTH	CAIXA BOX	REFERÊNCIA REFERENCE
PERFIL BANCA VEDANTE 104		3950	25 UN	K502001417
TERMINAL DIREITO 134		-		K502001517
TERMINAL ESQUERDO 144	● ANODIZADO MATE MATT ANODIZED	-		K502001617
UNIÃO EXTERIOR 114		-	50 UN	K502001717
UNIÃO INTERIOR 124		-		K502001817



PERFIL VEDANTE 463

463 BACKSPLASH PROFILE

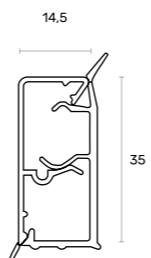

MODELO MODEL	ACABAMENTO FINISHING	COMPRIMENTO TOTAL TOTAL LENGTH	CAIXA BOX	REFERÊNCIA REFERENCE
PERFIL BANCA VEDANTE 463	● ANODIZADO MATE MATT ANODIZED	3900	10 UN	K502006801
ACESSÓRIOS 463		-	20 UN	K500006922

PERFIS PARA COZINHA

KITCHEN PROFILES

PERFIL VEDANTE 304

304 BACKSPLASH PROFILE

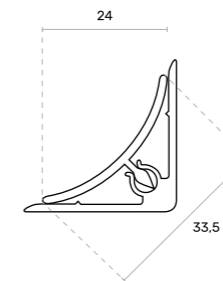

TERMINAL 334

FINISHING BORDER 334

UNIÃO EXTERIOR 314

OUTER BORDER 314

UNIÃO INTERIOR 324

INNER BORDER 324

MODELO MODEL	ACABAMENTO FINISHING	COMPRIMENTO TOTAL TOTAL LENGTH	CAIXA BOX	REFERÊNCIA REFERENCE
PERFIL BANCA VEDANTE 304		3950	25 UN	K502001917
TERMINAL 334	● ANODIZADO MATE MATT ANODIZED	-		K502002017
UNIÃO EXTERIOR 314		-	50 UN	K502002117
UNIÃO INTERIOR 324		-		K502002217

PERFIL VITRINE ADESIVO

ADHESIVE ALUMINIUM PROFILE

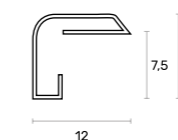

ESQUADRO ADESIVO VITRINE

BRACKET

MODELO MODEL	ACABAMENTO FINISHING	COMPRIMENTO TOTAL TOTAL LENGTH	CAIXA BOX	REFERÊNCIA REFERENCE
PERFIL VITRINE ADESIVO	○ BRANCO WHITE	-	75 UN	K501004326
	● ANODIZADO MATE MATT ANODIZED	-		K501004301
ESQUADRO ADESIVO VITRINE	○ BRANCO WHITE	-	400 UN	K500004426
	● ANODIZADO MATE MATT ANODIZED	-		K500004401

PERFIS PARA COZINHA

KITCHEN PROFILES

PERFIS PARA COZINHA

KITCHEN PROFILES

PERFIL VITRINE A
A DOOR PROFILE



PERFIL VITRINE A1
A1 DOOR PROFILE



PERFIL VITRINE B
B DOOR PROFILE



PERFIL VITRINE D
D DOOR PROFILE



PERFIL VITRINE 2465
2465 DOOR PROFILE

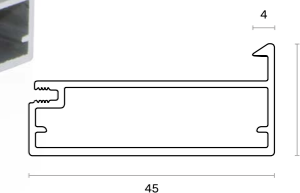
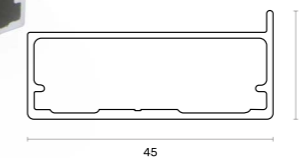
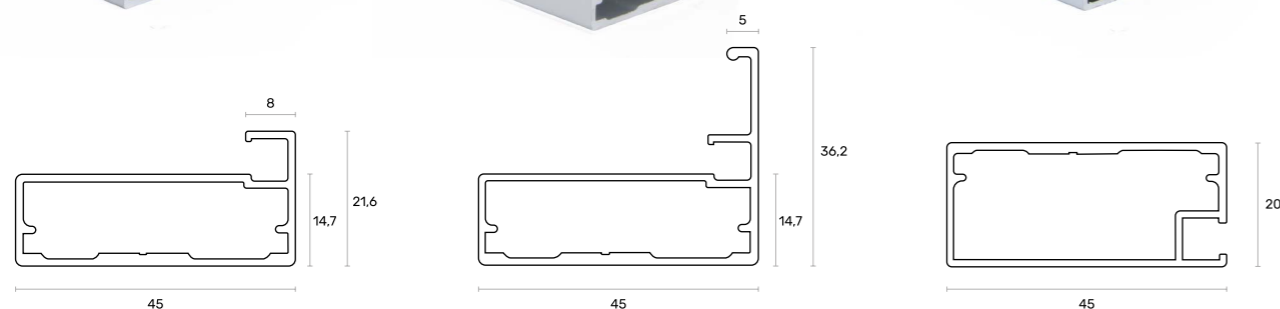

MODELO MODEL	ACABAMENTO FINISHING	COMPRIMENTO TOTAL TOTAL LENGTH	CAIXA BOX	REFERÊNCIA REFERENCE
PERFIL VITRINE A	BRANCO MATE MATT WHITE	5000	02 UN	K505002703
	ANODIZADO ANODIZED			K505002701
	INOX MATE MATT CHAMPAGNE ANODIZED			K505002711
	OURO MATE MATT GOLD COLOURED			K505002734
	PRETO MATE MATT BLACK			K505002709
PERFIL VITRINE A1	BRANCO MATE MATT WHITE	5000	02 UN	K505002803
	ANODIZADO ANODIZED			K505002801
	PRETO MATE MATT BLACK			K505002809
PERFIL VITRINE B	BRANCO MATE MATT WHITE	5000	02 UN	K505002903
	ANODIZADO ANODIZED			K505002901
	OURO MATE MATT GOLD COLOURED			K505002934
	OURO BRILHO BRIGHT GOLD COLOURED			K505002906
	PRETO MATE MATT BLACK			K505002909
PERFIL PLÁSTICO VITRINE 01		3000	01 UN	K501005419
ESQUADRO VITRINE 01			01 UN	K500004520



PERFIL PLÁSTICO VITRINE 01
01 GLASS PROTECTION PROFILE



ESQUADRO VITRINE 01
01 BRACKET

MODELO MODEL	ACABAMENTO FINISHING	COMPRIMENTO TOTAL TOTAL LENGTH	CAIXA BOX	REFERÊNCIA REFERENCE
PERFIL VITRINE D	BRANCO MATE MATT WHITE	5000	02 UN	K505003003
	ANODIZADO ANODIZED	5200		K506003001
	PRETO MATE MATT BLACK	5000		K505003009
ESQUADRO VITRINE 01			01 UN	K500004520
PERFIL VITRINE 2465	BRANCO MATE MATT WHITE	4100	16 UN	K502005003
	ANODIZADO ANODIZED			K502005001
	PRETO MATE MATT BLACK			K502005009
ESQUADRO VITRINE 2465			1000 UN	K500005120

PERFIL VITRINE 195
195 DOOR PROFILE

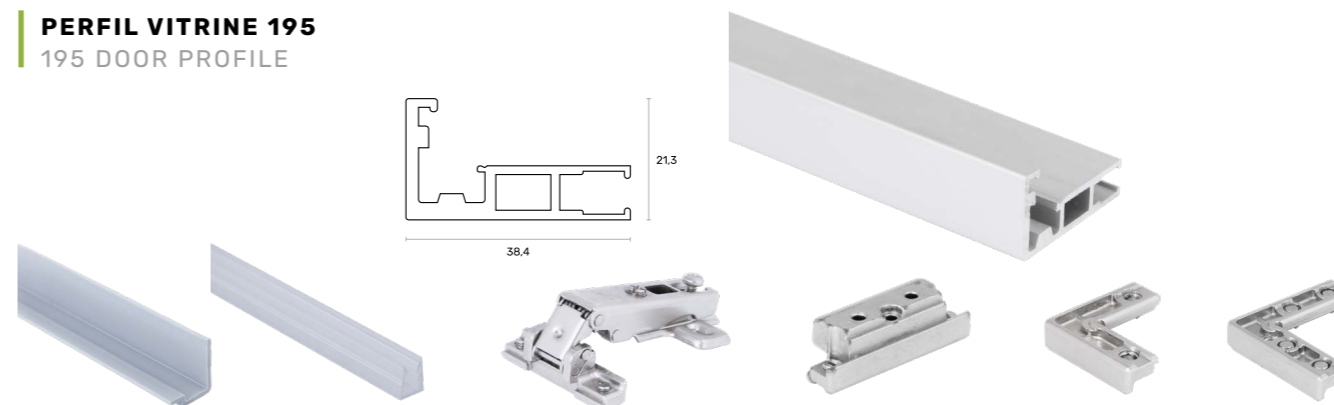

CALHAS PLÁSTICO - COBERTURA E VIDRO PROFILE FOR GLASS AND INTERNAL CARTER | **DOBRADIÇA 195** 195 HINGE | **BASE P/COMPASSO** GAS SPRING BASE | **ESQUADROS MS E MSD** MS AND MSD CONNECTORS

MODELO MODEL	COMPRIMENTO TOTAL TOTAL LENGTH	CAIXA BOX	REFERÊNCIA REFERENCE
PERFIL VITRINE 195 - ANODIZADO	4100	02 UN	K50E003401
PERFIL VITRINE 195 - PLÁSTICO COBERTURA	2500	01 UN	K50F003522
PERFIL VITRINE 195 - PLÁSTICO VIDRO	2500	01 UN	K50F003619
DOBRADIÇA	C=0	-	K500003720
	C=8	200 UN	K500003820
	C=15	-	K500003920
BASE COMPASSO PARA PERFIL 195	-	250 UN	K500004020
ESQUADRO LIGAÇÃO	MS	-	K500004120
	MSD	-	K500004220

PERFIS PARA ROUPEIRO

WARDROBE PROFILES



PERFIL PUXADOR 01
01 HANDLE PROFILE

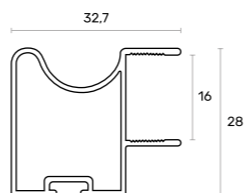

MODELO MODEL	ACABAMENTO FINISHING	COMPRIMENTO TOTAL TOTAL LENGTH	CAIXA BOX	REFERÊNCIA REFERENCE
	○ LACADO BRANCO MATE MATT WHITE	5000	10 UN	R705000103
		5200		R706000103
	○ LACADO BRANCO BRILHO BRIGHT WHITE	5000	10 UN	R705000102
		5200		R706000102
		6500		R708000102
	● ANODIZADO ANODIZED	5000	10 UN	R705000101
		5200		R706000101
		6500		R708000101
	● INOX MATE MATT CHAMPAGNE ANODIZED	5000	10 UN	R705000111
		5000		R705000110
	● OURO MATE MATT GOLD COLOURED	5000	10 UN	R705000134
		5000		R705000133
	● BRONZE BRILHO SHINE BRASS	5000	10 UN	R705000104
		5000		R705000109
	● LACADO PRETO MATE BLACK LACQUERED MATT	5000	10 UN	R705000109
		ACABAMENTO FOLHEADO EM MADEIRA WOOD PLATED FINISH		
	● FAIA BRANCA BEECH	4700	10 UN	R703000163
		5000		R705000163
		5200		R706000163
	● FAIA VAPORIZADA BEECH	4000	10 UN	R702000164
		4700		R703000164
		5000		R705000164
		5200		R706000164
	● MAPLE MAPLE	5000	10 UN	R705000166

PERFIL PUXADOR 01

PERFIS PARA ROUPEIRO

WARDROBE PROFILES

MODELO MODEL	ACABAMENTO FINISHING	COMPRIMENTO TOTAL TOTAL LENGTH	CAIXA BOX	REFERÊNCIA REFERENCE
	● PINHO PINE	4700	10 UN	R703000169
		5000		R705000169
		5200		R706000169
	● CARVALHO OAK	4000	10 UN	R702000161
		4700		R703000161
		5000		R705000161
		5200		R706000161
	● CEREJEIRA CHERRY	6500	10 UN	R708000161
		4000		R702000162
		4700		R703000162
	● FREIXO ASH	5000	10 UN	R705000162
		5000		R705000184
		5200		R706000162
	● TOLA TOLA / NIGERIAN CEDER	4000	10 UN	R702000171
		4700		R703000171
		5000		R705000171
	● IZOMBÉ IZOMBE	4700	10 UN	R703000165
		5000		R705000165
	● AFEZÉLIA AFZELIA	5000	10 UN	R705000160
		4700		R703000167
	● MOGNO MAHOGAN	5000	10 UN	R705000167
		5200		R706000167
	● NOGUEIRA WALNUT	4700	10 UN	R703000168
		5000		R705000168
	● SUCUPIRA SUCUPIRA	5200	10 UN	R706000168
		5000		R705000170
	● WENGUÉ WENGE	5000	10 UN	R705000172
		5200		R706000170
ACABAMENTO FOLHEADO EM MELAMINA MELAMINE PLATED FINISH				
	● MELAMINA FAIA VAPORIZADA BEECH MELAMINE	5000	10 UN	R705000176
		5000		R705000181
	● MELAMINA PINHO PINE MELAMINE	5000	10 UN	R705000173
		5000		R705000174
	● MELAMINA CEREJEIRA CHERRY MELAMINE	5000	10 UN	R705000179
		5000		R705000179

PERFIL PUXADOR 01

PERFIS PARA ROUPEIRO

WARDROBE PROFILES



PERFIL PUXADOR 04
04 HANDLE PROFILE

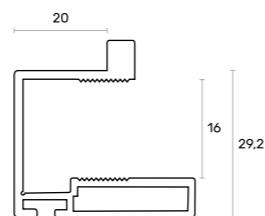

MODELO MODEL	ACABAMENTO FINISHING	COMPRIMENTO TOTAL TOTAL LENGTH	CAIXA BOX	REFERÊNCIA REFERENCE	
PERFIL PUXADOR 04	○ LACADO BRANCO MATE MATT WHITE	5000	10 UN	R705000403	
	○ LACADO BRANCO BRILHO BRIGHT WHITE	5000	10 UN	R705000402	
		5000		R705000401	
	● ANODIZADO ANODIZED	5200	10 UN	R706000401	
		6500		R70B000401	
	● INOX MATE MATT CHAMPAGNE ANODIZED	5000	10 UN	R705000411	
	ACABAMENTO FOLHEADO EM MADEIRA WOOD PLATED FINISH				
	● FAIA VAPORIZADA BEECH	5000	10 UN	R705000464	
		5200		R706000464	
	● PINHO PINE	5000	10 UN	R705000469	
		5000		R705000461	
	● CARVALHO OAK	5200	10 UN	R706000461	
	5000		R705000472		
● WENGÜE WENGE	5000	10 UN	R705000472		



PERFIL PUXADOR 261
261 HANDLE PROFILE

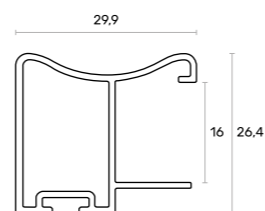

MODELO MODEL	ACABAMENTO FINISHING	COMPRIMENTO TOTAL TOTAL LENGTH	CAIXA BOX	REFERÊNCIA REFERENCE	
PERFIL PUXADOR 261	● ANODIZADO ANODIZED	5000	10 UN	R705000301	
	ACABAMENTO FOLHEADO EM MADEIRA WOOD PLATED FINISH				
	● CARVALHO OAK	5000	10 UN	R705000361	
ACABAMENTO FOLHEADO EM MELAMINA MELAMINE PLATED FINISH					
	● MELAMINA FAIA VAPORIZADA BEECH MELAMINE	4800	10 UN	R704000376	

PERFIS PARA ROUPEIRO

WARDROBE PROFILES

PERFIL PUXADOR 70
70 HANDLE PROFILE

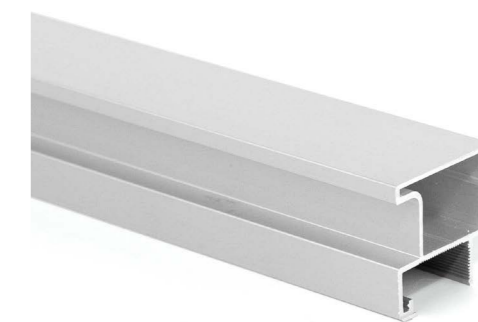
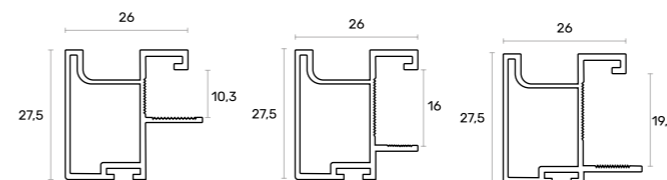

MODELO MODEL	ACABAMENTO FINISHING	COMPRIMENTO TOTAL TOTAL LENGTH	CAIXA BOX	REFERÊNCIA REFERENCE
PERFIL PUXADOR 70 10MM	○ BRANCO MATE MATT WHITE			R705007103
	○ BRANCO BRILHO BRIGHT WHITE			R705007102
	● ANODIZADO ANODIZED	5000	10 UN	R705007101
	● OURO MATE MATT GOLD COLOURED			R705007134
	● PRETO MATE MATT BLACK			R705007109
PERFIL PUXADOR 70 16MM	○ BRANCO MATE MATT WHITE			R705007003
	○ BRANCO BRILHO BRIGHT WHITE			R705007002
	● ANODIZADO ANODIZED	5000	10 UN	R705007001
	● OURO MATE MATT GOLD COLOURED			R705007034
	● PRETO MATE MATT BLACK			R705007009
PERFIL PUXADOR 70 19MM	○ BRANCO MATE MATT WHITE			R705007203
	○ BRANCO BRILHO BRIGHT WHITE			R705007202
	● ANODIZADO ANODIZED	5000	10 UN	R705007201
	● OURO MATE MATT GOLD COLOURED			R705007234
	● PRETO MATE MATT BLACK			R705007209

PERFIL PUXADOR 285
285 HANDLE PROFILE

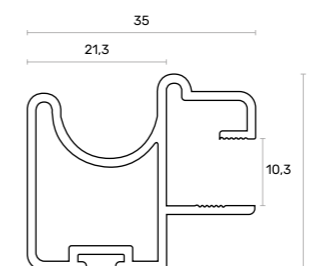

PLACA
10MM

MODELO MODEL	ACABAMENTO FINISHING	COMPRIMENTO TOTAL TOTAL LENGTH	CAIXA BOX	REFERÊNCIA REFERENCE
PERFIL PUXADOR 285	● ANODIZADO ANODIZED	5200	10 UN	R706000501

PERFIS PARA ROUPEIRO

WARDROBE PROFILES



PERFIL PUXADOR FE-05
FE-05 HANDLE PROFILE

PLACA
16MM

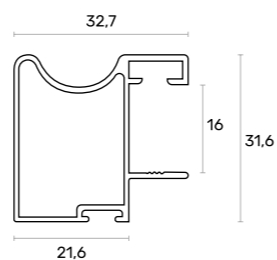

MODELO MODEL	ACABAMENTO FINISHING	COMPRIMENTO TOTAL TOTAL LENGTH	CAIXA BOX	REFERÊNCIA REFERENCE
PERFIL PUXADOR FE-05	ANODIZADO ANODIZED	5000	10 UN	R705004601



PERFIL PUXADOR FE-07
FE-07 HANDLE PROFILE

PLACA
16MM

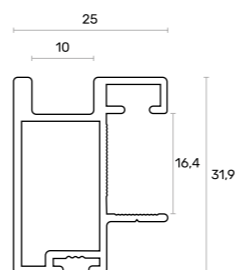

MODELO MODEL	ACABAMENTO FINISHING	COMPRIMENTO TOTAL TOTAL LENGTH	CAIXA BOX	REFERÊNCIA REFERENCE
PERFIL PUXADOR FE-07	LACADO BRANCO MATE MATT WHITE	5000	10 UN	R705004803
	ANODIZADO ANODIZED			R705004801
	LACADO PRETO MATE MATT BLACK			R705004809



PERFIL SUPERIOR FE-14
FE-14 TOP TRACK

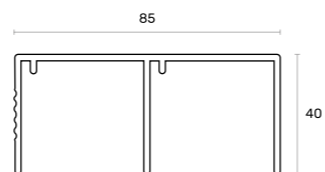

MODELO MODEL	ACABAMENTO FINISHING	COMPRIMENTO TOTAL TOTAL LENGTH	CAIXA BOX	REFERÊNCIA REFERENCE
PERFIL SUPERIOR FE-14	ANODIZADO ANODIZED	5000	10 UN	R705005001

PERFIS PARA ROUPEIRO

WARDROBE PROFILES

PERFIL SUPERIOR 06
06 TOP TRACK

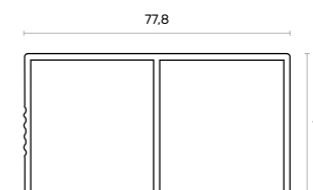

MODELO MODEL	ACABAMENTO FINISHING	COMPRIMENTO TOTAL TOTAL LENGTH	CAIXA BOX	REFERÊNCIA REFERENCE		
PERFIL SUPERIOR 06	LACADO BRANCO MATE MATT WHITE	5000	04 UN	R705000603		
	LACADO BRANCO BRILHO BRIGHT WHITE	5000		R705000602		
	ANODIZADO ANODIZED	5000		R705000601		
		6000		R707000601		
	INOX MATE MATT CHAMPAGNE ANODIZED	5000		R705000611		
	INOX BRILHO BRIGHT CHAMPAGNE ANODIZED	5000		R705000610		
	OURO MATE MATT GOLD COLOURED	5000		R705000634		
	BRONZE MATE MATT BRASS	5000		R705000633		
	BRONZE BRILHO BRIGHT BRASS	5000		R705000604		
	LACADO PRETO MATE MATT BLACK	5000		R705000609		
	ACABAMENTO FOLHEADO EM MADEIRA WOOD PLATED FINISH					
	FAIA BRANCA BEECH	5000		R705000663		
	FAIA VAPORIZADA BEECH	4000		R702000664		
		5000		R705000664		
PINHO PINE	5000	R705000669				
	4000	R702000661				
	5000	R705000661				
	5000	R705000662				
	6000	R707000662				
FREIXO ASH	5000	R705000684				
TOLA TOLA / NIGERIAN CEDER	5000	R705000671				
IZOMBÉ IZOMBE	5000	R705000665				
	5000	R705000667				
	6000	R707000667				
SUCUPIRA SUCUPIRA	5000	R705000670				
WENGUÉ WENGE	5000	R705000672				

PERFIS PARA ROUPEIRO

WARDROBE PROFILES

MODELO MODEL	ACABAMENTO FINISHING	COMPRIMENTO TOTAL TOTAL LENGTH	CAIXA BOX	REFERÊNCIA REFERENCE
ACABAMENTO FOLHEADO EM MELAMINA MELAMINE PLATED FINISH				
PERFIL SUPERIOR 06	MELAMINA FAIA VAPORIZADA BEECH MELAMINE	5000		R705000676
	MELAMINA PINHO PINE MELAMINE	5000		R705000681
	MELAMINA CARVALHO OAK MELAMINE	5000	04 UN	R705000673
	MELAMINA CEREJEIRA CHERRY MELAMINE	5000		R705000674
	MELAMINA MOGNO MAHOGANY MELAMINE	5000		R705000679



PERFIL SUPERIOR 33
33 TOP TRACK

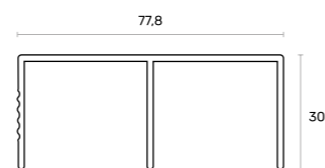

MODELO MODEL	ACABAMENTO FINISHING	COMPRIMENTO TOTAL TOTAL LENGTH	CAIXA BOX	REFERÊNCIA REFERENCE
PERFIL SUPERIOR 33	ANODIZADO ANODIZED	5000	04 UN	R705000701
		5400		R70A000701



PERFIL J6 MONOCARRIL INVERTIDO
J6 INVERTED MONORAIL PROFILE

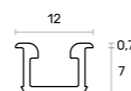

MODELO MODEL	ACABAMENTO FINISHING	COMPRIMENTO TOTAL TOTAL LENGTH	CAIXA BOX	REFERÊNCIA REFERENCE
PERFIL J6 MONOCARRIL INVERTIDO	ANODIZADO BRILHO BRIGHT ANODIZED	4200	01 UN	2714342101
	ANODIZADO MATE MATT ANODIZED			2714342510

PERFIS PARA ROUPEIRO

WARDROBE PROFILES

PERFIL SUPERIOR J6
J6 TOP TRACK

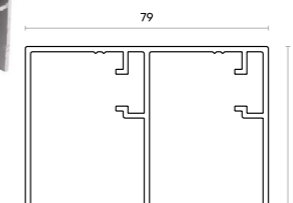
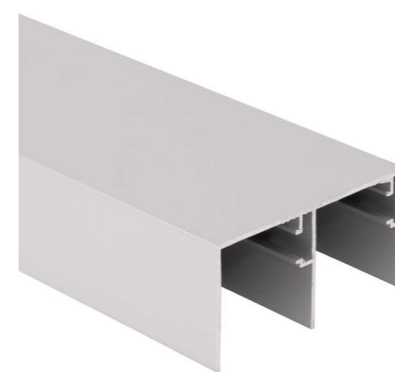

PERFIL INFERIOR J6
J6 BOTTOM TRACK

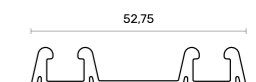

MODELO MODEL	ACABAMENTO FINISHING	COMPRIMENTO TOTAL TOTAL LENGTH	CAIXA BOX	REFERÊNCIA REFERENCE
PERFIL SUPERIOR J6	ANODIZADO MATE MATT ANODIZED	4200		2715542516
	LACADO BRANCO WHITE	6100	01 UN	2715561803
PERFIL INFERIOR J6	ANODIZADO MATE MATT ANODIZED	6100		2715561512
	ANODIZADO MATE MATT ANODIZED	4200		2714242513
	LACADO BRANCO WHITE	6100	01 UN	2714261800
	ANODIZADO MATE MATT ANODIZED	6100		2714251516

BOLSA J6- 2 PORTAS
J6 - 2 DOORS

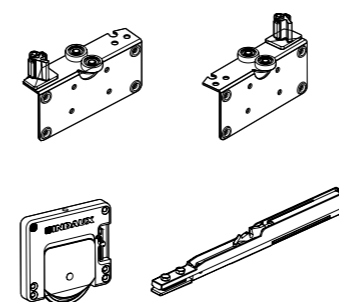

BOLSA J6- 3 PORTAS
J6 - 3 DOORS

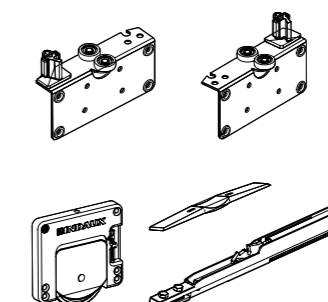

AMORTECEDOR J6
J6 SOFT-CLOSE

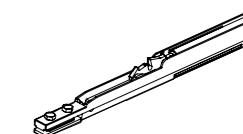

MODELO MODEL	CAIXA BOX	REFERÊNCIA REFERENCE
BOLSA J6 - 2 PORTAS INDAMATIC - 15KG - 50KG		2704402101
BOLSA J6 - 3 PORTAS INDAMATIC - 15KG - 50KG	01 UN	2704403103
AMORTECEDOR INDAMATIC J6 - 15KG - 50KG		2197500100

PERFIS PARA ROUPEIRO

WARDROBE PROFILES

PERFIS PARA ROUPEIRO

WARDROBE PROFILES

PERFIL INFERIOR 08

08 BOTTOM TRACK



MODELO MODEL	ACABAMENTO FINISHING	COMPRIMENTO TOTAL TOTAL LENGTH	CAIXA BOX	REFERÊNCIA REFERENCE
PERFIL INFERIOR 08	○ LACADO BRANCO MATE MATT WHITE	5000	10 UN	R705000803
	○ LACADO BRANCO BRILHO BRIGHT WHITE	5000		R705000802
	● ANODIZADO ANODIZED	5000		R705000801
		6000		R707000801
	● INOX MATE MATT CHAMPAGNE ANODIZED	5000		R705000811
	● INOX BRILHO BRIGHT CHAMPAGNE ANODIZED	5000		R705000810
	● OURO MATE MATT GOLD COLOURED	5000		R705000834
	● BRONZE MATE MATT BRASS	5000		R705000833
	● BRONZE BRILHO BRIGHT BRASS	5000		R705000804
	● LACADO PRETO MATE MATT BLACK	5000		R705000809
PERFIL INFERIOR FE-10	● ANODIZADO ANODIZED	5000	10 UN	R705004901

PERFIL INFERIOR FE-10

FE-10 BOTTOM PROFILE



PERFIL INFERIOR INVERTIDA 02 E 20

02 AND 20 INVERTED BOTTOM TRACK



MODELO MODEL	ACABAMENTO FINISHING	COMPRIMENTO TOTAL TOTAL LENGTH	CAIXA BOX	REFERÊNCIA REFERENCE
PERFIL INFERIOR INVERTIDA 02 (45)	○ LACADO BRANCO MATE MATT WHITE	5000	10 UN	R705000903
	○ LACADO BRANCO BRILHO BRIGHT WHITE	5000		R705000902
	● ANODIZADO ANODIZED	6000		R707000902
		5000		R705000901
	● ANODIZADO ANODIZED	5400		R70A000901
	● INOX BRILHO BRIGHT CHAMPAGNE ANODIZED	5000		R705000910
PERFIL INFERIOR INVERTIDA 20 (48)	○ BRANCO BRILHO BRIGHT WHITE	5000	10 UN	R705002002
	● ANODIZADO ANODIZED			R705002001
PERFIL INFERIOR INVERTIDA 2721	○ BRANCO MATE MATT WHITE	5000	10 UN	R705001003
	○ BRANCO BRILHO BRIGHT WHITE			R705001002
	● ANODIZADO ANODIZED			R705001001
	● INOX MATE MATT CHAMPAGNE ANODIZED			R705001011
	● PRETO MATE MATT BLACK			R705001009

PERFIL INFERIOR INVERTIDA 281

281 INVERTED BOTTOM TRACK



MODELO MODEL	ACABAMENTO FINISHING	COMPRIMENTO TOTAL TOTAL LENGTH	CAIXA BOX	REFERÊNCIA REFERENCE
PERFIL INFERIOR INVERTIDA 281	○ BRANCO MATE MATT WHITE	5000	10 UN	R705001103
	○ BRANCO BRILHO BRIGHT WHITE			R705001102
	● ANODIZADO ANODIZED			R705001101
CLIP	-	-	25 UN	CL.I.INV

PERFIL MONOCARRIL 22

22 MONORAIL PROFILE



MODELO MODEL	ACABAMENTO FINISHING	COMPRIMENTO TOTAL TOTAL LENGTH	CAIXA BOX	REFERÊNCIA REFERENCE
PERFIL MONOCARRIL 22	● ANODIZADO ANODIZED	5000	10 UN	R705002201
PERFIL MONOCARRIL INVERTIDA 13	● BRUTO RAW	5000	10 UN	R705001307
	● ANODIZADO ANODIZED			R705001301

PERFIL MONOCARRIL INVERTIDA 13

13 INVERTED MONORAIL PROFILE



PERFIS PARA ROUPEIRO

WARDROBE PROFILES

PERFIS PARA ROUPEIRO

WARDROBE PROFILES

PERFIL H H PROFILE



PERFIL U U PROFILE



MODELO MODEL	ACABAMENTO FINISHING	COMPRIMENTO TOTAL TOTAL LENGTH	CAIXA BOX	REFERÊNCIA REFERENCE			
PERFIL H 16 MM	BRANCO MATE MATT WHITE	5000	10 UN	R705001403			
	BRANCO BRILHO BRIGHT WHITE			R705001402			
	ANODIZADO ANODIZED			R705001401			
	INOX MATE MATT CHAMPAGNE ANODIZED			R705001411			
	BRONZE BRILHO BRIGHT BRASS			R705001404			
	PRETO MATE MATT BLACK			R705001409			
	ACABAMENTO FOLHEADO EM MADEIRA WOOD PLATED FINISH						
	FAIA VAPORIZADA BEECH			R705001464			
	PINHO PINE			R705001469			
	CERVALHO OAK			R705001461			
CEREJEIRA CHERRY	R705001462						
TOLA TOLA / NIGERIAN CEDER	R705001471						
MOGNO MAHOGANY	R705001467						
PERFIL U 16 MM	BRANCO MATE MATT WHITE	5000	10 UN	R705001503			
	BRANCO BRILHO BRIGHT WHITE			R705001502			
	ANODIZADO ANODIZED			R705001501			
	INOX MATE MATT CHAMPAGNE ANODIZED			R705001511			
	INOX BRILHO BRIGHT CHAMPAGNE ANODIZED			R705001510			
	OURO MATE MATT GOLD COLOURED			R705001534			
	OURO BRILHO BRIGHT GOLD COLOURED			R705001506			
	BRONZE BRILHO BRIGHT BRASS			R705001504			
	PRETO MATE MATT BLACK			R705001509			
	PRETO BRILHO BRIGHT BLACK			R705001508			
ACABAMENTO FOLHEADO EM MADEIRA WOOD PLATED FINISH							
FAIA VAPORIZADA BEECH	R705001564						
PINHO PINE	R705001569						
CERVALHO OAK	R705001561						
CEREJEIRA CHERRY	R705001562						
TOLA TOLA / NIGERIAN CEDER	R705001571						
MOGNO MAHOGANY	R705001567						

PERFIL H H PROFILE

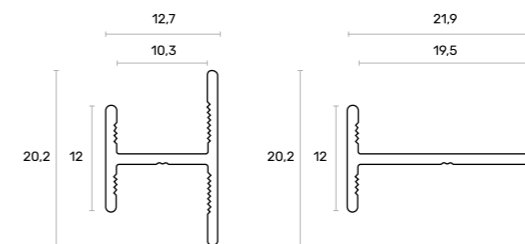

PERFIL U U PROFILE

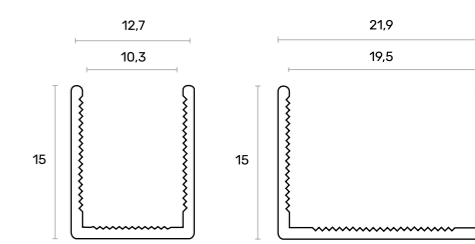

MODELO MODEL	ACABAMENTO FINISHING	COMPRIMENTO TOTAL TOTAL LENGTH	CAIXA BOX	REFERÊNCIA REFERENCE
PERFIL H 10 MM	BRANCO MATE MATT WHITE	5000	10 UN	R705007503
	BRANCO BRILHO BRIGHT WHITE			R705007502
	ANODIZADO ANODIZED			R705007501
	OURO MATE MATT GOLD COLOURED			R705007534
	PRETO MATE MATT BLACK			R705007509
PERFIL H 19 MM	BRANCO MATE MATT WHITE	5000	10 UN	R705007603
	BRANCO BRILHO BRIGHT WHITE			R705007602
	ANODIZADO ANODIZED			R705007601
	OURO MATE MATT GOLD COLOURED			R705007634
	PRETO MATE MATT BLACK			R705007609
PERFIL U 10 MM	BRANCO MATE MATT WHITE	5000	10 UN	R705007303
	BRANCO BRILHO BRIGHT WHITE			R705007302
	ANODIZADO ANODIZED			R705007301
	OURO MATE MATT GOLD COLOURED			R705007334
	PRETO MATE MATT BLACK			R705007309
PERFIL U 19 MM	BRANCO MATE MATT WHITE	5000	10 UN	R705007403
	BRANCO BRILHO BRIGHT WHITE			R705007402
	ANODIZADO ANODIZED			R705007401
	OURO MATE MATT GOLD COLOURED			R705007434
	PRETO MATE MATT BLACK			R705007409

PERFIS PARA ROUPEIRO

WARDROBE PROFILES

KIT SPACE

SPACE KIT

TUBO OVAL C/ REFORÇO

REINFORCED WARDROBE RAIL

TUBO OVAL

WARDROBE RAIL

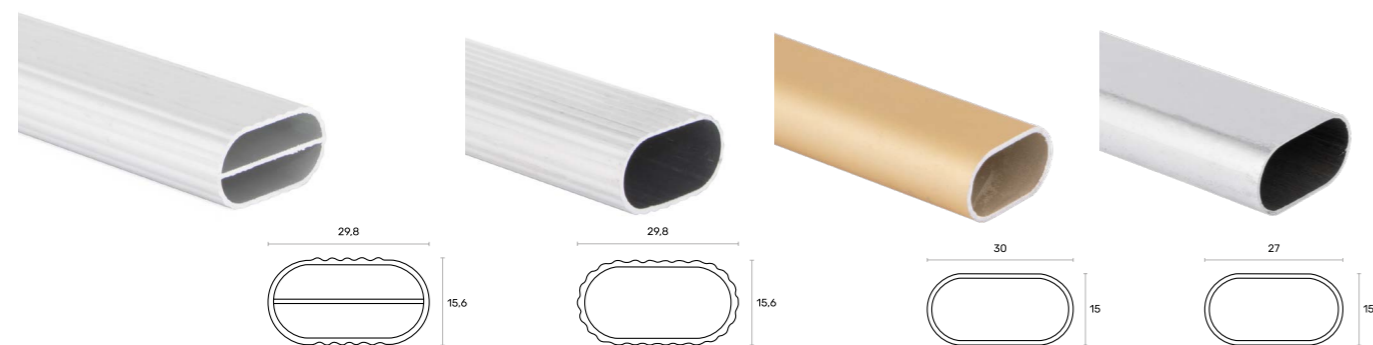

TUBO BOX RETANGULAR

BOX SQUARE RAIL

SUPORTES LATERAIS E CENTRAL BOX

BOX END AND CENTER SUPPORT



PERFIL SUPERIOR SPACE

SPACE UPPER PROFILE

PERFIL INFERIOR SPACE

SPACE BOTTOM PROFILE

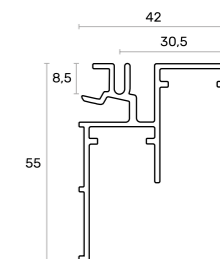
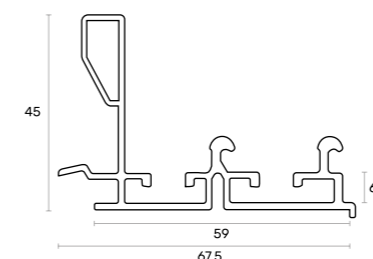

JOGO DE AMORTECEDORES SPACE

SPACE SOFT CLOSING SYSTEM

JOGO DE TRAVÕES SPACE

SPACE SET OF BRAKE

JOGO EXT. SPACE / JOGO INT. SPACE

SPACE SLIDING SETS

MODELO MODEL	ACABAMENTO FINISHING	COMPRIMENTO TOTAL TOTAL LENGTH	CAIXA BOX	REFERÊNCIA REFERENCE
TUBO OVAL C/ REFORÇO	ANODIZADO ANODIZED	5000	10 UN	R705001601
	BRUTO RAW			R705001607
TUBO OVAL	ANODIZADO ANODIZED	5000	10 UN	R705001701
	BRUTO RAW	4000		R702001707
		5000		R705001707
	CROMADO POLISHED CHROME PLATED	3000		R705001805
TUBO BOX RETANGULAR	OURO MATE MATT GOLD COLOURED	5000	10 UN	R705001934
	BRANCO MATE MATT WHITE			R705005203
TUBO BOX LED RETANGULAR	ANODIZADO ANODIZED	5000	10 UN	R705005201
	PRETO MATE MATT BLACK			R705005209
JOGO SUPORTES LATERAIS BOX	BRANCO MATE MATT WHITE		10 UN	R705005303
	ANODIZADO ANODIZED	-		R705005301
	PRETO MATE MATT BLACK			R705005309
SUPORTE CENTRAL BOX	BRANCO MATE MATT WHITE		10 UN	R710006103
	ANODIZADO ANODIZED	-		R710006101
	PRETO MATE MATT BLACK			R710006109
	BRANCO MATE MATT WHITE		10 UN	R710006203
	ANODIZADO ANODIZED	-		R710006201
	PRETO MATE MATT BLACK			R710006209

MODELO MODEL	ACABAMENTO FINISHING	COMPRIMENTO TOTAL TOTAL LENGTH	CAIXA BOX	REFERÊNCIA REFERENCE
PERFIL SUPERIOR SPACE	ANODIZADO ANODIZED	3900		R702006501
PERFIL INFERIOR SPACE		3900		R702006601
JOGO ACESSÓRIOS EXT. SPACE	-	-	01 UN	R706021920
JOGO ACESSÓRIOS INT. SPACE	-	-		R706021720
JOGO AMORTECEDORES SPACE - 50KG 2P	-	-		R706022320
JOGO AMORTECEDORES SPACE - 50KG 3P	-	-		R706022420
JOGO TRAVÕES SPACE - 2/3P	-	-		R706022520

OUTROS PERFIS

OTHER PROFILES



PERFIL PC 22
PC 22 PROFILE



KIT PC 25
PC 25 KIT

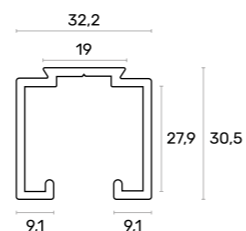

MODELO MODEL	ACABAMENTO FINISHING	COMPRIMENTO TOTAL TOTAL LENGTH	CAIXA BOX	REFERÊNCIA REFERENCE
PERFIL PC 22	● BRUTO RAW	5000	10 UN	R805000807
KIT PC 25	-	-	-	R800001200
FIXADOR PC 04	● BRUTO RAW	-	100 UN	R800000407



PERFIL PC 02 E PC 19
PC 02 AND PC 19 RAIL

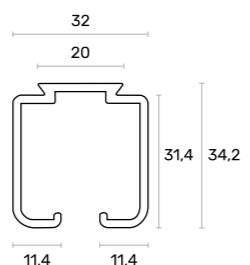

PC 02
PC 02

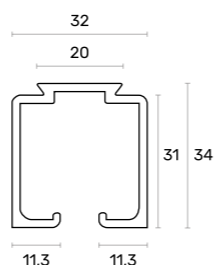

PC 19
PC 19



FIXADOR PC 04
PC 04 CONNECTOR



KIT PC 14
PC 14 KIT



KIT PC 15
PC 15 KIT

MODELO MODEL	ACABAMENTO FINISHING	COMPRIMENTO TOTAL TOTAL LENGTH	CAIXA BOX	REFERÊNCIA REFERENCE
PERFIL PC 02	● BRUTO RAW	4000	10 UN	R802000207
		5000	10 UN	R805000207
PERFIL PC 19	● BRUTO RAW	4000	10 UN	R802001907
		5000	10 UN	R805001907
KIT PORTA CORRER 14	-	-	20 UN	R800000620
KIT PORTA CORRER 15	-	-	20 UN	R800000720
FIXADOR PC 04	-	-	100 UN	R800000407

OUTROS PERFIS

OTHER PROFILES

PERFIL PC 37
PC 37 PROFILE



KIT PC 37 (AMORTECEDOR)
PC 37 KIT (SOFT CLOSE)

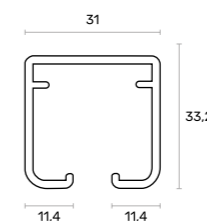

MODELO MODEL	ACABAMENTO FINISHING	COMPRIMENTO TOTAL TOTAL LENGTH	CAIXA BOX	REFERÊNCIA REFERENCE
PERFIL PC37	● BRUTO RAW	4000	-	R802000307
		5000	10 UN	R805000307
KIT PC 37 (AMORTECEDOR)	-	-	-	R800000520

PERFIL 12 LED E 12 B LED EMBUTIR
12 LED AND 12 B LED PROFILE FOR RECESSED



PERFIL DIFUSOR 12 LED
12 LED DIFFUSER PROFILE



MODELO MODEL	ACABAMENTO FINISHING	COMPRIMENTO TOTAL TOTAL LENGTH	CAIXA BOX	REFERÊNCIA REFERENCE
PERFIL 12 LED EMBUTIR	○ BRANCO MATE MATT WHITE	5000	10 UN	I125001203
	● ANODIZADO ANODIZED			I125001201
	● PRETO MATE MATT BLACK			I125001209
PERFIL 12 B LED EMBUTIR	○ BRANCO MATE MATT WHITE	5000	10 UN	I125001403
	● ANODIZADO ANODIZED			I125001401
	● PRETO MATE MATT BLACK			I125001409
PERFIL DIFUSOR 12 LED	○ TRANSPARENTE TRANSPARENT	5000	10 UN	I125001319
	○ BRANCO WHITE			I125001326
	● CINZA FUMADO SMOKED GREY			I125001330

PERFIL SUPERIOR 329

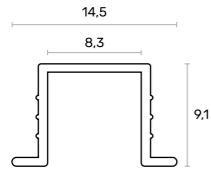
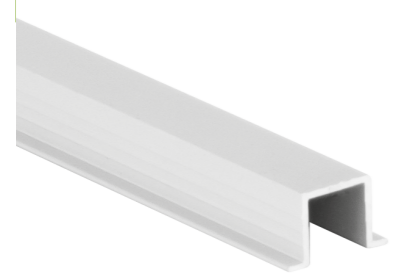

PERFIL INFERIOR 329

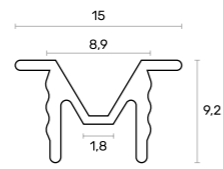

JOGO DE CARROS SD 329
SD 329 ROLLERS SET

MODELO MODEL	ACABAMENTO FINISHING	COMPRIMENTO TOTAL TOTAL LENGTH	CAIXA BOX	REFERÊNCIA REFERENCE
PERFIL SUPERIOR 329	● ANODIZADO ANODIZED	5000	40 UN	R805001001
		6000		R807001001
	● PRETO MATE MATT BLACK	5000		R805001009
		6000		R807001009
PERFIL INFERIOR 329	● ANODIZADO ANODIZED	5000	40 UN	R805000901
		6000		R807000901
	● PRETO MATE MATT BLACK	5000		R805000909
		6000		R807000909
JOGO DE 2 CARROS SD 329	-	-	40 UN	R800001121



PERFIL FLOW
FLOW PROFILE

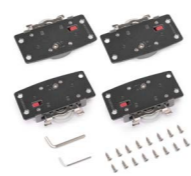
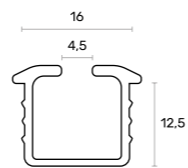

AMORTECEDOR FLOW - 30KG E 50KGS
FLOW DOOR SOFT CLOSING FOR SLIDING DOOR

JOGO DE CARROS FLOW
FLOW SET FOR ONE SLIDING DOOR

JOGO DE CARROS FLOW 9
FLOW 9 SET FOR ONE SLIDING DOOR

MODELO MODEL	ACABAMENTO FINISHING	COMPRIMENTO TOTAL TOTAL LENGTH	CAIXA BOX	REFERÊNCIA REFERENCE
PERFIL FLOW	● ANODIZADO ANODIZED	3900	20 UN	R802002501
AMORTECEDOR FLOW - 30KG	-	-	05 UN	R800002700
AMORTECEDOR FLOW - 50KG	-	-	05 UN	R800002800
JOGO DE CARROS FLOW	-	-	05 UN	R800002600
JOGO DE CARROS FLOW 9	-	-	05 UN	R800003009

PERFIL TUBULAR FE-19
FE-19 TUBULAR PROFILE

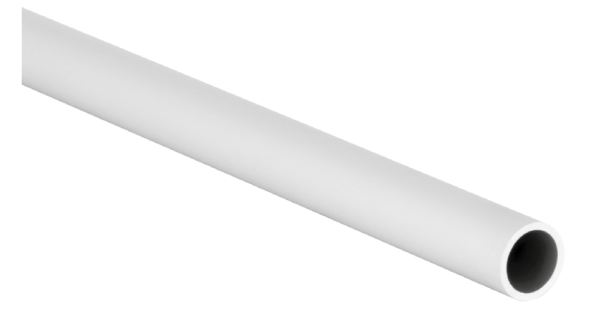

MODELO MODEL	ACABAMENTO FINISHING	MEDIDAS MEASURES	COMPRIMENTO TOTAL TOTAL LENGTH	CAIXA BOX	REFERÊNCIA REFERENCE
PERFIL TUBULAR FE-19	● CROMADO POLISHED CHROME PLATED	16x1.2	3000	30 UN	R801003005
	● ANODIZADO ANODIZED	16x1.5	5000	10 UN	R805002101
		16x1			R805002301

PERFIL EXPOSITOR 055
055 SINGLE SLOTTED PROFILE

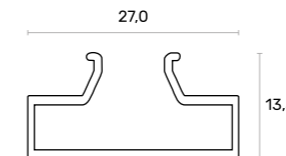

MODELO MODEL	ACABAMENTO FINISHING	COMPRIMENTO TOTAL TOTAL LENGTH	CAIXA BOX	REFERÊNCIA REFERENCE
PERFIL EXPOSITOR 055	● BRUTO GROSS	5000	10 UN	R805000107

PERFIL BASE
BASE PROFILE



MODELO MODEL	ACABAMENTO FINISHING	MEDIDAS MEASURES	COMPRIMENTO TOTAL TOTAL LENGTH	CAIXA BOX	REFERÊNCIA REFERENCE		
PERFIL BASE	○ BRANCO MATE MATT WHITE	18x5	5000	10 UN	R805002503		
	● BRUTO RAW				R805002507		
	○ BRANCO MATE MATT WHITE	18x10			5000	10 UN	R805002603
	● BRUTO RAW						R805002607

10

ROUPEIROS
WARDROBES

~~184~~ **ACESSÓRIOS ROUPEIRO**
WARDROBE ACCESSORIES

A NOSSA PRODUÇÃO.



FIXO MILD 17.8
FIXED MILD 17.8

MILD 19.2
MILD 19.2

MODELO MODEL	CAIXA BOX	REFERÊNCIA REFERENCE
RODÍZIOS SUPERIORES		
FIXO MILD 17.8	C/ ROLAMENTO	FR71000001
MILD 19.2	C/ ROLAMENTO	FR71000002



MILD FEMEA 03
MILD 03

MILD MACHO 04
MILD 04

MODELO MODEL	CAIXA BOX	REFERÊNCIA REFERENCE
RODÍZIOS INFERIORES		
MILD FEMEA 03		FR71000003
MILD MACHO 04	3MM	FR71000004

SCW - AMORTECEDOR PARA ROUPEIRO
SCW - SOFT CLOSER FOR WARDROBE



MODELO MODEL	CAIXA BOX	REFERÊNCIA REFERENCE
SCW - CONJUNTO AMORTECEDORES PARA ROUPEIRO		
CAPACIDADE MÁXIMA: 50 KG MAXIMUM LOADING CAPACITY: 50 KG		
PARA QUALQUER TIPO DE PORTA DE CORRER PARA ROUPEIRO FOR ANY WARDROBE SLIDING DOOR	25 UN	R710000100
SUBSTITUI RODÍZIOS SUPERIORES REPLACE UPPER ROLLERS		

RODÍZIOS SUPERIORES
UPPER ROLLERS



205
205

10R
10R

9
9

MODELO MODEL	CAIXA BOX	REFERÊNCIA REFERENCE
RODÍZIOS SUPERIORES		
205	C/ ROLAMENTO	R710000421
10R	C/ ROLAMENTO	R710000520
9	-	R710000620

RODÍZIOS INFERIORES
BOTTOM ROLLERS

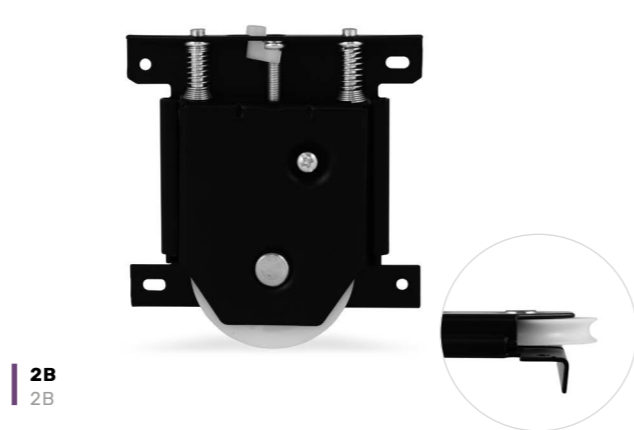
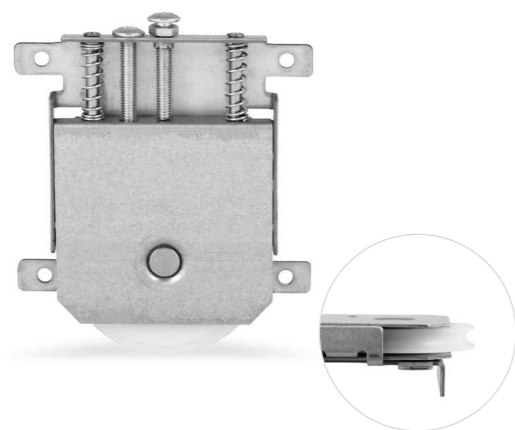

2
2

2B
2B

MODELO MODEL	ACABAMENTO FINISHING	CAIXA BOX	REFERÊNCIA REFERENCE
RODÍZIOS INFERIORES		2	100 UN R710000920
	● PRETO BLACK	2B	120 UN R710005009

PORTA FATOS ESSENCE
ESSENCE WARDROBE LIFT HANGER



MODELO MODEL	ACABAMENTO FINISHING	CAIXA BOX	REFERÊNCIA REFERENCE
PORTA FATOS ESSENCE	● CINZA GREY	450 - 600	R710005522
	● CINZA GREY	600 - 830	R710005622
	● PRETO BLACK	600 - 830	06 UN R710005609
	● CINZA GREY	830 - 1150	R710005722
	● PRETO BLACK	830 - 1150	R710005709

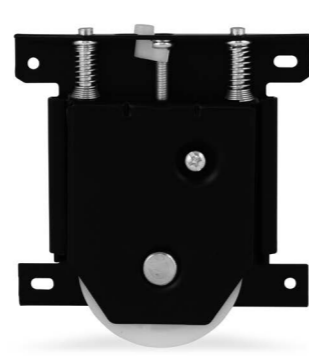
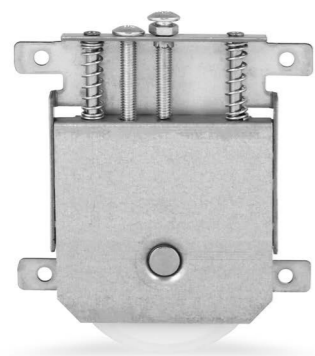

MODELO MODEL	ACABAMENTO FINISHING	CAIXA BOX	REFERÊNCIA REFERENCE
RODÍZIOS INFERIORES		3MM	R710001020
		4MM	R710001120
		5MM	100 UN R710001220
		6MM	R710001320
	● PRETO BLACK	4B	120 UN R710005109



ACESSÓRIOS ROUPEIRO

WARDROBE ACCESSORIES

SAPATEIRA EXTENSÍVEL H35

H35 EXTENDABLE SHOE RACK



CABIDE EXTRAÍVEL - TROMBONE

TROMBONE - PULL-OUT HANGER



MODELO MODEL	CAIXA BOX	REFERÊNCIA REFERENCE
SAPATEIRA EXTENSÍVEL H35	400 - 600 (MIN. 368)	C/CORREDIÇA H35
	600 - 1000 (MIN. 568)	C/CORREDIÇA H35
SET FIXADOR FRONTAL SAPATEIRA H35		
	01 UN	R710003722
CABIDE EXTRAÍVEL - TROMBONE		TROMBONE 300
		TROMBONE 350
		TROMBONE 400
		TROMBONE 450
		TROMBONE 500



CROMADO
CHROME

CALCEIRO SIMPLES - 11 BRAÇOS

PULL OUT TROUSER RACK

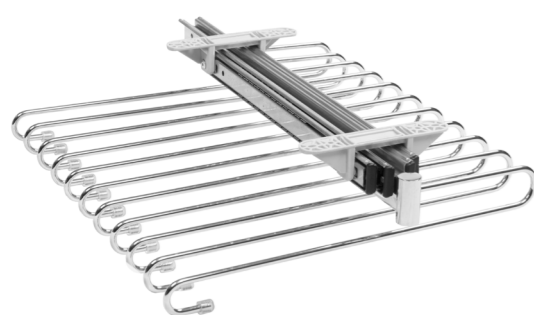

CALCEIRO DUPLO - 20 BRAÇOS

PULL OUT TROUSER RACK



MODELO MODEL	ACABAMENTO FINISHING	CAIXA BOX	REFERÊNCIA REFERENCE
CALCEIRO	CROMADO CHROME	SIMPLES - 11 BRAÇOS	05 UN
		DUPLO - 20 BRAÇOS	02 UN
	ALUMÍNIO ALUMINIUM	QUADRO MOD.600 - 8 VARETAS	01 UN
		QUADRO MOD.900 - 14 VARETAS	01 UN

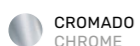

CROMADO
CHROME



ALUMÍNIO
ALUMINIUM

ACESSÓRIOS ROUPEIRO

WARDROBE ACCESSORIES



ESTICADOR PARA PORTA 9253

9253 STRAIGHTENERS FOR WARDROBE DOOR



ESTICADOR PARA PORTA 1920

1920 STRAIGHTENERS FOR WARDROBE DOOR

MODELO MODEL	CAIXA BOX	REFERÊNCIA REFERENCE
ESTICADOR PARA PORTA 9253	50 UN	R710002700
ESTICADOR PARA PORTA 1920	25 UN	R710002601

TUBO COM SENSOR - CASTOR

CASTOR - TUBE WITH SENSOR



MODELO MODEL	ACABAMENTO FINISHING	MEDIDAS MEASURES	CAIXA BOX	REFERÊNCIA REFERENCE
TUBO COM SENSOR CASTOR	MATE MATTE	558 0.6W/BN	01 UN	R700003001
	MOKA MOKA			R700003036
	MATE MATTE	708 0.7W/BN	01 UN	R700003101
	MOKA MOKA			R700003136
	MATE MATTE	858 0.9W/BN	01 UN	R700003201
	MOKA MOKA			R700003236
	MATE MATTE	1008 1W/BN	01 UN	R700003301
	MOKA MOKA			R700003336
	MATE MATTE	1158 1.2W/BN	01 UN	R700003401
	MOKA MOKA			R700003436



MATE
MATTE



MOKA
MOKA



MATE
MATTE



MOKA
MOKA



MATE
MATTE



MOKA
MOKA



MATE
MATTE



MOKA
MOKA



SUPORTE LATERAL
RAIL END SUPPORT

SUPORTE LATERAL 2630
2630 RAIL END SUPPORT

SUPORTES LATERAIS REGULÁVEIS 4005
4005 RAIL END SUPPORTS



JOGO DE SUPORTES LATERAIS - SILK
SILK RAIL SUPPORT SET

SUPORTE CENTRAL - SILK
SILK RAIL CENTRAL SUPPORT

SUPORTE DE CANTO - SILK
SILK RAIL ANGULAR SUPPORT



SUPORTES CENTRAIS
RAIL CENTRAL SUPPORT

SUPORTE CENTRAL REGULÁVEL 4105
4105 RAIL CENTRAL SUPPORT

MODELO MODEL	ACABAMENTO FINISHING	CAIXA BOX	REFERÊNCIA REFERENCE
SUPORTE LATERAL	- ANODIZADO ANODIZED	100 UN	R710003801
	- BRUTO RAW		R710003807
SUPORTE LATERAL 2630	- BRUTO RAW	10 UN	R710004207
SUPORTES LATERAIS 4005	405 - REGULÁVEL CROMADO POLISHED CHROME PLATED	10 UN	R710004005
	4005 - REGULÁVEL OURO BRILHO BRIGHT GOLD COLOURED		R710004006
SUPORTES CENTRAIS	- ANODIZADO ANODIZED		R710003901
	- BRUTO RAW	50 UN	R710003907
	- OURO MATE MATT GOLD COLOURED		R710004534
SUPORTES CENTRAIS 4105	REGULÁVEL CROMADO POLISHED CHROME PLATED	10 UN	R710004105
	FIXO OURO MATE MATT GOLD COLOURED		R710004534

MODELO MODEL	ACABAMENTO FINISHING	CAIXA BOX	REFERÊNCIA REFERENCE
JOGO DE SUPORTES LATERAIS - SILK		10 UN	R710102530
SUPORTE CENTRAL - SILK		20 UN	R710312530
SUPORTE DE CANTO - SILK		20 UN	R710322530

PELÚCIA
SLIDING DOORS BRUSH



MODELO MODEL	ACABAMENTO FINISHING	MEDIDAS MEASURES	CAIXA BOX	REFERÊNCIA REFERENCE
PELÚCIA	● CINZA GREY	6.5X6		R710004722
		7X12	01 UN	R710004822

11

SISTEMAS DE FIXAÇÃO E MONTAGEM CONNECTION AND MOUNTING SYSTEMS

~~194~~ **PARAFUSOS**
SCREWS

~~197~~ **TAPA PARAFUSOS + BATENTES**
ADHESIVE HOLE COVERS AND BUMPERS

~~199~~ **SUPORTES PRATELEIRA**
SHELF SUPPORTS

~~199~~ **ESQUADROS**
CONNECTION BRACKETS

~~204~~ **SISTEMAS FIXAÇÃO**
CONNECTION SYSTEMS

~~207~~ **FECHOS (TIC-TAC E MAGNÉTICOS)**
PUSH TO OPEN SYSTEMS

~~209~~ **DESLIZADORES**
GLIDES

~~210~~ **NIVELADORES**
LEVELLERS

PARAFUSOS

SCREWS



MODELO MODEL	COR COLOR	MEDIDAS MEASURES	CAIXA BOX	REFERÊNCIA REFERENCE
		2,5X12		PCCZ251220
		2,5X16		PCCZ251620
		2,5X20		PCCZ252020
		3,0X16		PCCZ301620
		3,0X20		PCCZ302020
		3,0X25		PCCZ302520
		3,0X30		PCCZ303020
		3,0X35		PCCZ303520
		3,0X45		PCCZ304520
		3,0X50		PCCZ305020
		3,0X40		PCCZ304020
		3,5X12		PCCZ351220
		3,5X16		PCCZ351620
		3,5X18		PCCZ351820
		3,5X20	1000 UN	PCCZ352020
		3,5X25		PCCZ352520
		3,5X30		PCCZ353020
		3,5X35		PCCZ353520
		3,5X40		PCCZ354020
		3,5X45		PCCZ354520
		3,5X50		PCCZ355020
		4,0X16		PCCZ401620
		4,0X18		PCCZ401820
		4,0X20		PCCZ402020
		4,0X25		PCCZ402520
		4,0X30		PCCZ403020
		4,0X35		PCCZ403520
		4,0X40		PCCZ404020
		4,0X45		PCCZ404520
		4,0X50		PCCZ405020
		4,0X55		PCCZ405520
		4,0X60		PCCZ406020
		4,0X70		PCCZ407020
		4,5X45		PCCZ454520
		4,5X50		PCCZ455020
		4,5X60		PCCZ456020
		4,5X70		PCCZ457020
		4,5X80	500 UN	PCCZ458020
		5,0X40		PCCZ504020
		5,0X50		PCCZ505020
		5,0X60		PCCZ506020
		5,0X70		PCCZ507020
		5,0X80		PCCZ508020
		6,0X40		PCCZ604020
		6,0X80		PCCZ608020
		6,0X100		PCCZ6010020
		6,0X120	200 UN	PCCZ6012020
		6,0X150		PCCZ6015020

ZINCADO
ZINC

ZINCADO
ZINC

ZINCADO
ZINC

PARAFUSOS ZEME

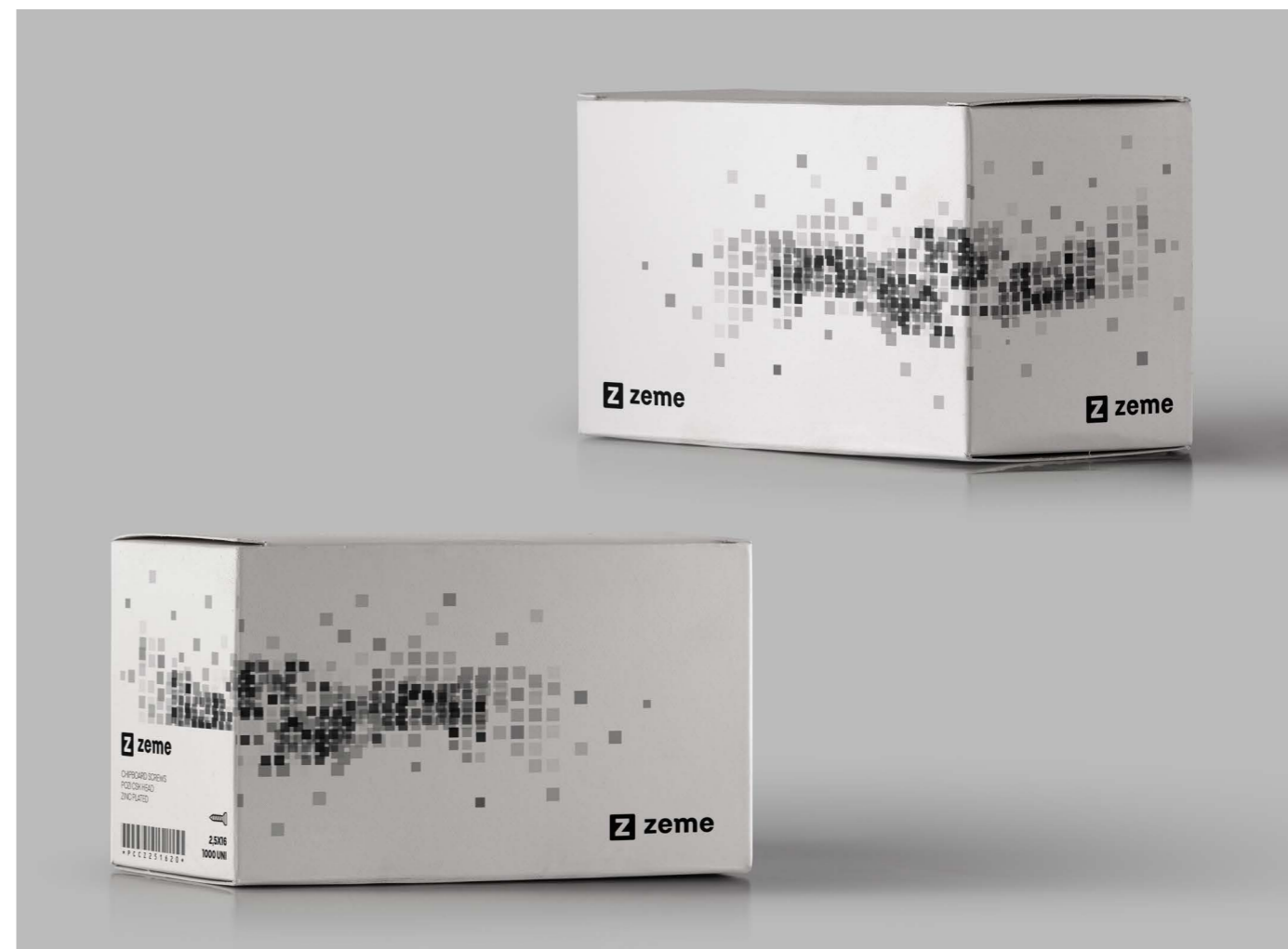

MODELO MODEL	COR COLOR	MEDIDAS MEASURES	CAIXA BOX	REFERÊNCIA REFERENCE
		3,5X45		PTBZ354520
		3,5X50		PTBZ355020
TORX BROCA	ZINCADO ZINC	4,0X40	1000 UN	PTBZ404020
		4,0X45		PTBZ404520
		4,0X50		PTBZ405020
		4,0X60	500 UN	PTBZ406020
		3,0X20		PTOZ302020
		3,0X25		PTOZ302520
		3,0X30		PTOZ303020
		3,5X16		PTOZ351620
		3,5X20		PTOZ352020
		3,5X25		PTOZ352520
		3,5X30		PTOZ353020
		3,5X40		PTOZ354020
TORX	ZINCADO ZINC	3,5X45	1000 UN	PTOZ354520
		3,5X50		PTOZ355020
		4,0X16		PTOZ401620
		4,0X20		PTOZ402020
		4,0X30		PTOZ403020
		4,0X35		PTOZ403520
		4,0X40		PTOZ404020
		4,0X45		PTOZ404520
		4,0X50		PTOZ405020

PARAFUSOS

SCREWS



PARAFUSOS DE MONTAGEM
5X50 SCREW



ESCAPULA COM FENDA
6,3X54 HOCK



PARAFUSOS LIGAÇÃO
CONNECTOR SCREW



HASTES ROSCADAS
THREADED ROD



ADAPTADOR UNIVERSAL
MAGNETIC BIT HOLDER



PONTEIRAS
POZIDRIVE AND TORX BITS

MODELO MODEL	COR COLOR	TIPO TYPE	CAIXA BOX	REFERÊNCIA REFERENCE
ESCAPULA COM FENDA	ZINCADO ZINC	6,3X54	1500 UN	PES0635420
PARAFUSO MONTAGEM	ZINCADO ZINC	5X50	3500 UN	PM00505020
PARAFUSOS DE LIGAÇÃO SEXTAVADO INTERIOR	NIQUEL NICKEL	M-06X35	1000 UN	R900031214
		M-06X40		R900031314
		M-06X50		R900031414
		M-06X60		R900031514
PORCA M6 FENDA MISTA	NIQUEL NICKEL	M-06	3000 UN	R900012414
PORCA M6 SEXTAVADA	NIQUEL NICKEL	M-06	3000 UN	R900012514
HASTE ROSCADA	ZINCADO ZINC	M6X20	01 UN	R900010520
		M6X22		R900010620
		M6X25		R900010720
		M6X28		R900010820
		M6X30		R900010920
		M6X35		R900011020
		M8X30		R900011220
VARÃO ROSCADO	ZINCADO ZINC	M6X1000	01 UN	R900012220
		M8X1000		R900012320
ADAPTADOR UNIVERSAL	-	1/4 50MM	01 UN	PPA5000000
PONTEIRAS	-	BITS - TORX 15	10 UN	PPT1500000
PONTEIRAS ZEME	ZINCADO ZINC	BITS - PZ1X25		PPCCZPZ125
		BITS - PZ2X25		PPCCZPZ225
		BITS - PZ3X25	100 UN / 10 UN (CX)	PPCCZPZ325
		BITS - TORX 10X25		PPT0ZT1025
		BITS - TORX 20X25		PPT0ZT2025

TAPA-PARAFUSOS

ADHESIVE HOLE COVERS

MODELO MODEL	CÓDIGO CODE	ACABAMENTO FINISHING	DIMENSÃO DIMENSION	CAIXA BOX	REFERÊNCIA REFERENCE
000		PINTÁVEL PAINTABLE	Ø13	2000 UN	R900130000
			Ø20	900 UN	R900200000
744		BRANCO WHITE	Ø13	2000 UN	R900130744
			Ø20	900 UN	R900200744
982		BRANCO WHITE	Ø13	2000 UN	R900130982
			Ø20	900 UN	R900200982
562		CINZA GREY	Ø13	2000 UN	R900130562
			Ø20	900 UN	R900200562
935		CINZA GREY	Ø13	2000 UN	R900130935
			Ø20	900 UN	R900200935
001		CINZA GREY	Ø13	2000 UN	R900130001
			Ø20	900 UN	R900200001
01 A		ALUMÍNIO ALUMINUM	Ø13	2000 UN	R90013001A
			Ø20	900 UN	R90020001A
007		ALUMÍNIO ALUMINUM	Ø13	2000 UN	R900130007
			Ø20	900 UN	R900200007
052		ANTRACITE ANTHRACITE	Ø13	2000 UN	R900130052
			Ø20	900 UN	R900200052
657		PRETO BLACK	Ø13	2000 UN	R900130567
			Ø20	900 UN	R900200567
115		LINHO GRID	Ø13	2000 UN	R900130115
			Ø20	900 UN	R900200115
116		LINHO GRID	Ø13	2000 UN	R900130116
			Ø20	900 UN	R900200116
117		LINHO GRID	Ø13	2000 UN	R900130117
			Ø20	900 UN	R900200117
374		FAIA BEECH	Ø13	2000 UN	R900130374
			Ø20	900 UN	R900200374
569		CARVALHO OAK	Ø13	2000 UN	R900130569
			Ø20	900 UN	R900200569
045		NOGUEIRA WALNUT	Ø13	2000 UN	R900130045
			Ø20	900 UN	R900200045
988		MOGNO MAHOGANY	Ø13	2000 UN	R900130988
			Ø20	900 UN	R900200988
994		WENGUÉ WENGE	Ø13	2000 UN	R900130994
			Ø20	900 UN	R900200994

TAPA PARAFUSOS

BATENTES

BUMPERS



BATENTE AUTOCOLANTE
ADHESIVE SHOCK ABSORVER

BATENTE NORBIDO
NORBIDO SHOCK ABSORVER

BATENTE BIM
BIM SHOCK ABSORVER

MODELO MODEL	COR COLOR	MEDIDAS MEASURES	CAIXA BOX	REFERÊNCIA REFERENCE
BATENTE AUTOCOLANTE	○ TRANSPARENTE TRANSPARENT	10X3	5000 UN	R900006519
		7X1,5	10 000 UN	R900006719
BATENTE NORBIDO	○ TRANSPARENTE TRANSPARENT ○ BRANCO WHITE	-	5000 UN	R900006819
		-		R900006826
BATENTE BIM Ø5	○ TRANSPARENTE TRANSPARENT ● ANTRACITE ANTHRACITE	Ø5	5000 UN	23203010ZZ
				23203010EE

SUPORTES DE PRATELEIRA

SHELF SUPPORTS

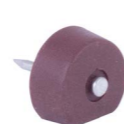

SUPORTE 802
802 SUPPORT

SUPORTE 26
26 SUPPORT

SUPORTE COM PREGO
NAIL SUPPORT



SUPORTE METÁLICO 02
02 METALLIC SUPPORT

SUPORTE 03
03 SUPPORT

HASTE ZINC 5X165
5X165 ZINC ROD

MODELO MODEL	COR COLOR	CAIXA BOX	REFERÊNCIA REFERENCE
SUPORTE 802	○ TRANSPARENTE TRANSPARENT	5000 UN	R900010319
			R900002619
SUPORTE 26	○ BRANCO WHITE ● CASTANHO BROWN	5000 UN	R900002626
			R900002627
			R900003226
SUPORTE COM PREGO	○ BRANCO WHITE ● CASTANHO BROWN	10 000 UN	R900003227
SUPORTE METÁLICO 02	● ZINCADO ZINC	5000 UN	R900015220
SUPORTE 03	● ZINCADO ZINC	1000 UN	R900016020
HASTE ZINC 5X165	● ZINCADO ZINC	5000 UN	R900002720



SUPORTES DE PRATELEIRA

SHELF SUPPORTS



SUPORTE K-LINE 1 PINO
SHELF SUPPORT
K-LINE W/1PIN Ø5

SUPORTE K-LINE 2 PINOS
SHELF SUPPORT
K-LINE W/2PINS Ø5

BASE SILICONE PARA K-LINE
RUBBER PAD FOR K-LINE
SHELF SUPPORT

PK2 19MM
PK2 19MM

MODELO MODEL	COR COLOR	TIPO TYPE	CAIXA BOX	REFERÊNCIA REFERENCE
SUPORTES PRATELEIRAS K-LINE	● NIQUEL NICKEL	1 PINO Ø5	5000 UN	10208020YA
		2 PINOS Ø5		10208050YA
	● NIQUEL PRETO BLACK NICKEL	1 PINO Ø5	5000 UN	10208020YQ
		2 PINOS Ø5		10208050YQ
BASE SILICONE	-	-	5000 UN	10208060AA
PK2	● CINZA GREY	19 MM	2500 UN	11401030IJ
				● NIQUEL NICKEL
	● PRETO BLACK			11401090IJ
	● NIQUEL PRETO BLACK NICKEL			11403020YQ



KUBIC
KUBIC



MODELO MODEL	COR COLOR	TIPO TYPE	CAIXA BOX	REFERÊNCIA REFERENCE
KUBIC	● NIQUEL NICKEL	VIDRO 4/8MM	2000 UN	16019020YA

SUPORTES DE PRATELEIRA

SHELF SUPPORTS

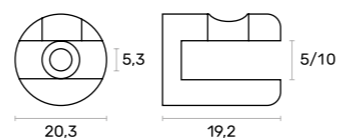
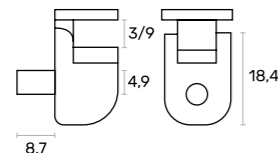

AJUSTÁVEL 01 VIDRO 9MM
01 GLASS SHELF SUPPORT 9MM

AJUSTÁVEL VIDRO 10MM
GLASS SHELF SUPPORT 10MM

MODELO MODEL	COR COLOR	CAIXA BOX	REFERÊNCIA REFERENCE
AJUSTÁVEL 01 VIDRO 9MM	● NIQUEL NICKEL	1000 UN	R900014820
AJUSTÁVEL VIDRO 10MM	● CROMADO MATE MATT CHROME PLATED	1800 UN	R900014618

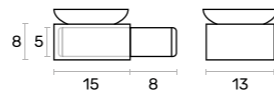
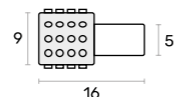
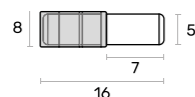

SOFT 101
101 SOFT GLASS SHELF SUPPORT

SOFT 153
153 SOFT GLASS SHELF SUPPORT

VENTOSA 29
29 SHELF SUPPORT WITH SUCTION

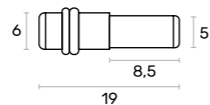

VENTOSA 310
310 SHELF SUPPORT WITH SUCTION (6MM)

ORING 6314
ORING 6314 SHELF SUPPORT

ORING E PORCA 12/30
ORING 12/30 SHELF SUPPORT

MODELO MODEL	COR COLOR	CAIXA BOX	REFERÊNCIA REFERENCE
SOFT 101	● CINZA GREY	5000 UN	R900010120
SOFT 153	○ TRANSPARENTE TRANSPARENT	5000 UN	R900015322
VENTOSA 29	○ TRANSPARENTE TRANSPARENT	500 UN	R900002919
VENTOSA 310	● ZINCADO ZINC	5000 UN	R900010220
ORING 6314	● ZINCADO ZINC	5000 UN	R900002820
ORING 12/30	● ZINCADO ZINC	200 UN	R900003020
PORCA 12/30	● ZINCADO ZINC	500 UN	R900003120



MOON S
S MOON



SUPORTES DE PRATELEIRA

SHELF SUPPORTS

KAIMAN
KAIMAN



MODELO MODEL	COR COLOR	TIPO TYPE	CAIXA BOX	REFERÊNCIA REFERENCE
MOON S	● ANODIZADO ANODIZED	S 4-25	24 UN	16228010UZ
	● PRETO MATE MATT BLACK			16228010EC
KAIMAN	● ANODIZADO ANODIZED	8-40MM	10 UN	16102020JL

SUPORTES INVISÍVEIS

SHELF SUPPORTS



TRIADE
TRIADE

M10
M10

F26
F26

MODELO MODEL	COR COLOR	TIPO TYPE	CAIXA BOX	REFERÊNCIA REFERENCE
TRIADE		INVISÍVEL 30MM		1621501000
M10	● NIQUEL NICKEL	INVISÍVEL	50 UN	R900029820
F26		INVISÍVEL		R900029920

ESQUADRO 2 FUROS
PULLING BRACKET

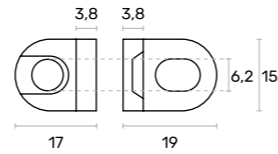

MODELO MODEL	COR COLOR	TIPO TYPE	CAIXA BOX	REFERÊNCIA REFERENCE
ESQUADRO 2 FUROS	NIQUEL NICKEL	2 FUROS	2500 UN	10203010YA

ESQUADROS PLÁSTICOS
PLASTICS CONNECTORS

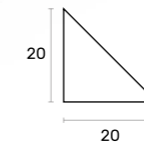

MODELO MODEL	COR COLOR	TIPO TYPE	CAIXA BOX	REFERÊNCIA REFERENCE
ESQUADROS PLÁSTICOS	CINZA GREY	2 FUROS	500 UN	R900000122
		4 FUROS	100 UN	R900000222
	PINHO MEL PINE	4 FUROS	100 UN	R900000231
		2 FUROS	500 UN	R900000127
CASTANHO BROWN	4 FUROS	100 UN	R900000227	
	PRETO BLACK	-	1000 UN	R900014021

CHAPA QUADRADA 127
127 SQUARE CONNECTOR

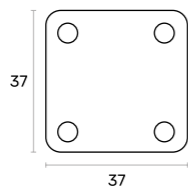

ESQUADRO PLANO 126
126 CONNECTOR

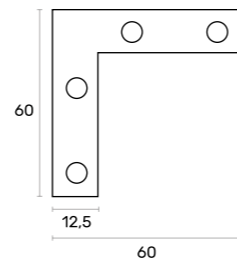

MODELO MODEL	COR COLOR	TIPO TYPE	CAIXA BOX	REFERÊNCIA REFERENCE
CHAPA QUADRADA 127	ZINCADO ZINC	4 FUROS	1000 UN	R900012720
ESQUADRO PLANO 126		4 FUROS	750 UN	R900012620

ESQUADROS METÁLICOS
METALLIC CONNECTORS

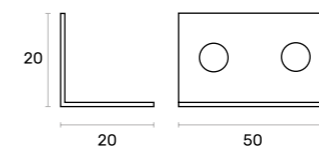
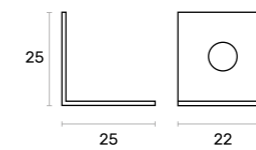

MODELO MODEL	COR COLOR	TIPO TYPE	CAIXA BOX	REFERÊNCIA REFERENCE
ESQUADROS METÁLICOS	ZINCADO ZINC	2 FUROS	2000 UN	R900000320
		4 FUROS	1000 UN	R900000420

CAVILHAS E LAMELAS
WOODEN BISCUIT AND DOWELS

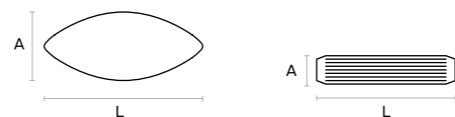

MODELO MODEL	COR COLOR	TIPO TYPE	CAIXA BOX	REFERÊNCIA REFERENCE
LAMELAS	● FAIA BEECH	10 (A19 X L53)	1000 UN	R900013664
		20 (A23 X L58)		R900013764
		A6 X L30		R9006X3064
		A6 X L35		R9006X3564
		A6 X L40		R9006X4064
CAVILHAS CALIBRADAS	● FAIA BEECH	A8 X L30	20 KG	R9008X3064
		A8 X L35		R9008X3564
		A8 X L40		R9008X4064
		A8 X L45		R9008X4564
		A10 X L40		R9010X4064
		A10 X L50		R9010X5064



TARGET J10
TARGET J10

PORCA SEM FIM M-06X10
INSERT NUT M6X10

PARAFUSOS TARGET Ø10
Ø10 TARGET SCREWS

MODELO MODEL	CAIXA BOX	REFERÊNCIA REFERENCE
TARGET J10	1000 UN	21802160ZN
PORCA SEM FIM M-06X10X13	5000 UN	20102020GR
PARAFUSO TARGET Ø10 (PLACA 16)	2000 UN	21821300YA
PARAFUSO TARGET Ø10 (PLACAS 18/19)	2000 UN	21821320YA

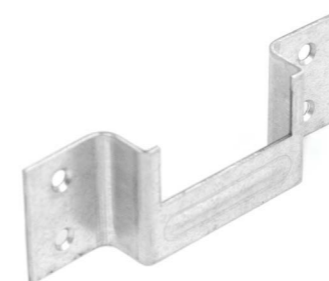

CHASSO BALIZA A
A BED HARDWARE

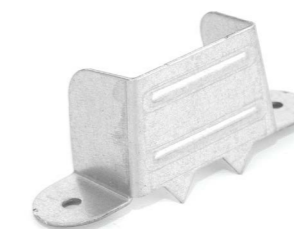

CHASSO SEM BEIRA B
B BED HARDWARE



ENGATE 2 PINOS D
D BED HARDWARE



ENGATE E - SET ENGATE SOFA
E - SOFA CONNECTOR SET



ENGATE F - SET ENGATE SOFA
F - SOFA CONNECTOR SET



CHAPA PARA MESA 01
01 - TABLE LEG CORNER BRACE

MODELO MODEL	COR COLOR	CAIXA BOX	REFERÊNCIA REFERENCE
CHASSO BALIZA A	○ ZINCADO BRANCO WHITE ZINC PLATED	200 UN	R900000520
CHASSO SEM BEIRA B			R900000720
ENGATE 2 PINOS D			R900001120
ENGATE E - SET ENGATES SOFA 96X47			FR90000002
ENGATE F - SET ENGATES SOFA 47X40			FR90000003
CHAPA PARA MESA 01			FR90000001

SISTEMAS DE FIXAÇÃO

CONNECTION SYSTEMS



LIGADOR BORBOLETA
BUTTERFLY CONNECTOR



LIGADOR 01
01 CONNECTOR



PORCAS SEM FIM
THREADED INSERT NUTS



BUCHA PLÁSTICA
PLASTIC DOWEL

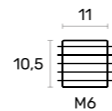
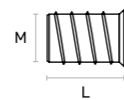

83/00
83/00



83/30
83/30



MINIFIXO 20
20 HOUSING CONNECTOR

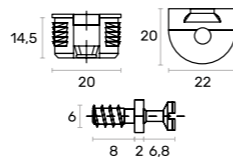
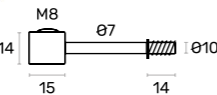

MODELO MODEL	COR COLOR	TIPO TYPE	CAIXA BOX	REFERÊNCIA REFERENCE
LIGADORES	ZINCADO ZINC	BORBOLETA	1000 UN	R900000820
	BRONZE BRASS			R900000804
	ZINCADO ZINC	01	500 UN	R900001020
	ZINCADO AMARELO YELLOW ZINC PLATED			R900001028
SISTEMA DE LIGAÇÃO 83/00	-	M-08	01 UN	R900024000
SISTEMA DE LIGAÇÃO 83/30	-	M-08		R900024100
PORCAS SEM FIM	ZINCADO ZINC	M-06XL13		R900001720
		M-08XL15	1000 UN	R900002020
		M-08XL22		R900002120
	ZINCADO AMARELO YELLOW ZINC PLATED	M-06XL15		R900001828
		M-08XL13	1000 UN	R900001928
		M-08XL25		R900002228
MINIFIXO 20	BRANCO WHITE	Ø20	1000 UN	R900001626
	CASTANHO BROWN			R900001627
	ZAMAK ZAMAK			R900001520
BUCHA PLÁSTICA	BRANCO WHITE	11X10,5MM	1000 UN	R900002526



FECHOS TIC TAC

PUSH TO OPEN SYSTEM

KPUSH TECH
KPUSH TECH



KPUSH STRONG
KPUSH STRONG



MODELO MODEL	COR COLOR	TIPO TYPE	CAIXA BOX	REFERÊNCIA REFERENCE
KPUSH	BRANCO WHITE	MAGNÉTICO	100 UN	57008020AB
		BATENTE		57008040AB
	CINZA GREY	MAGNÉTICO	100 UN	57008020IJ
		BATENTE		57008040IJ
BASE KPUSH	BRANCO WHITE	MAGNÉTICO	100 UN	57008020EE
		BATENTE		57008040EE
	CINZA GREY	-	100 UN	R900020226
		-		R900020230
KPUSH STRONG	BRANCO WHITE	MAGNÉTICO	100 UN	R900020224
		BATENTE		R900020230
	CINZA GREY	MAGNÉTICO	100 UN	57008060AB
		BATENTE		57008080AB
ANTRACITE ANTHRACITE	MAGNÉTICO	100 UN	57008060IJ	
	BATENTE		57008080IJ	
ANTRACITE ANTHRACITE	MAGNÉTICO	100 UN	57008060EE	
	BATENTE		57008080EE	

IMPULSE
IMPULSE PUSH TO OPEN



MODELO MODEL	COR COLOR	TIPO TYPE	CAIXA BOX	REFERÊNCIA REFERENCE
IMPULSE	ANTRACITE ANTHRACITE	MAGNÉTICO	100 UN	217440311
		BATENTE		215838313
BASE P/FECHO TIC-TAC IMPULSE	ANTRACITE ANTHRACITE	-	100 UN	214500145

FECHOS TIC TAC

PUSH TO OPEN SYSTEM



FECHO TIC-TAC 60/60M
60/60M PUSH TO OPEN



FECHO TIC-TAC 60/90B
60/90B PUSH TO OPEN



FECHO TIC-TAC 60/40M
60/40M PUSH TO OPEN

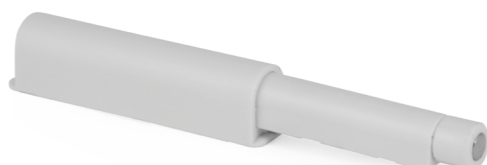

FECHO TIC-TAC 60/80M
60/80M PUSH TO OPEN

MODELO MODEL	COR COLOR	MEDIDAS MEASURES	TIPO TYPE	CAIXA BOX	REFERÊNCIA REFERENCE	
FECHOS TIC-TAC	○ BRANCO WHITE	60/60M	MAGNÉTICO	01 UN	R900009026	
		60/80M			R900009126	
		60/90B	BATENTE	01 UN	R900009226	
	● CINZA GREY	60/40M				R900008922
		60/60M	MAGNÉTICO	01 UN	R900009022	
		60/80M				R900009122
		60/90B	BATENTE	01 UN	R900009222	

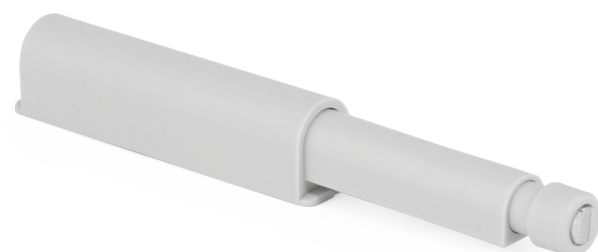

FECHO TIC-TAC 40M
40M PUSH TO OPEN

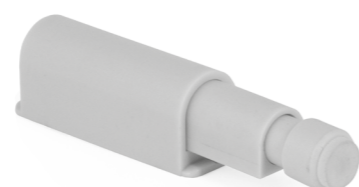

FECHO TIC-TAC 13B
13B PUSH TO OPEN

MODELO MODEL	COR COLOR	MEDIDAS MEASURES	TIPO TYPE	CAIXA BOX	REFERÊNCIA REFERENCE
FECHOS TIC-TAC	● CINZA GREY	13M	MAGNÉTICO	50 UN	R900008530
		40M			R900008730
		13B	BATENTE	50 UN	R900008430
		40B			R900008630
	● PRETO BLACK	40M	MAGNÉTICO	50 UN	R900008721
		40B	BATENTE		R900008621

FECHOS TIC TAC

PUSH TO OPEN SYSTEM



MAGNÉTICO PEQUENO
SMALL MAGNETIC



MAGNÉTICO 1010
1010 MAGNETIC



MAGNÉTICO MEF EXTRA FORTE
MEF STRONG MAGNETIC



FECHO PISTON
PISTON TIP LATCH



PLACA QUADRADA P/FECHO TIC-TAC
SQUARE PLATE PUSH TO OPEN



PLACA REDONDA P/FECHO TIC-TAC
ROUND PLATE PUSH TO OPEN

MODELO MODEL	COR COLOR	CAIXA BOX	REFERÊNCIA REFERENCE
MAGNÉTICO 096 PEQUENO	○ BRANCO WHITE	100 UN	R900009626
MAGNÉTICO 097 PEQUENO	● CASTANHO BROWN	100 UN	R900009727
MAGNÉTICO 1010	● INOX STAINLESS STEEL	16 UN	R900009812
MAGNÉTICO MEF EXTRA FORTE	○ BRANCO WHITE	30 UN	R900017003
	● PRETO BLACK	30 UN	R900017009
FECHO PISTON	-	100 UN	R900008327
PLACA QUADRADA P/FECHO TIC-TAC	-	800 UN	R900009420
PLACA REDONDA P/FECHO TIC-TAC	-	500 UN	R900009320

DESLIZADORES

GLIDES



DESLIZADORES DE AGRAFOS
STAPLE GLIDE

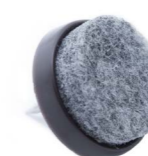

DESLIZADOR 4760
4760 FELT WITH NAIL



DESLIZADOR COM PREGO INJETADO
NAIL GLIDE

MODELO MODEL	COR COLOR	MEDIDAS MEASURES	CAIXA BOX	REFERÊNCIA REFERENCE
DESLIZADORES DE AGRAFOS	○ BRANCO WHITE	-	2000 UN	R900007926
	● CASTANHO BROWN	-		R900007927
DESLIZADOR 4760	● CASTANHO BROWN	22 MM		R900007727
		25 MM	01 UN	R900007827
		30 MM		R900007627
DESLIZADORES COM PREGO INJETADO	○ BRANCO WHITE	18 MM	1000 UN	R900014326
		20 MM		R900014526
		16 MM		R900007227
	● CASTANHO BROWN	16 MM		R900014127
		18 MM		R900014227
		20 MM		R900014427

NIVELADORES OCULTOS

UPPER MODULE HANGERS



NIVELADORES OCULTOS

UPPER MODULE HANGERS

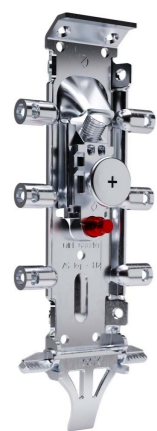

LIBRA H2
LIBRA H2 HANGER

LIBRA WP1
WP1 WALL PLATE

TAMPA LIBRA H2
LIBRA H2 COVER CAP Ø12

MODELO MODEL	COR COLOR	CAIXA BOX	REFERÊNCIA REFERENCE
LIBRA H2	● ZINCADO ZINC	100 UN	63420020ZN
LIBRA WP1	● ZINCADO ZINC	100 UN	63450015ZN
TAMPA LIBRA H2	○ BRANCO WHITE	100 UN	63461010AB
	● CINZA GREY		63461010IJ
	● ANTRACITE ANTHRACITE		63461010EE



NIVELADOR SPIDER
SPIDER HANGER

CHAPA SPIDER
SPIDER WALL PLATE

TAMPA Ø20MM APC
APC COVER CAP Ø20MM

MODELO MODEL	COR COLOR	CAIXA BOX	REFERÊNCIA REFERENCE
NIVELADOR SPIDER	● ZINCADO ZINC	100 UN	63510010ZN
CHAPA SPIDER	● ZINCADO ZINC	500 UN	63510025ZN



NIVELADOR TRASER 6
TRASER 6

CHAPA 31
31 WALL PLATE

TAMPA TRASER 6
TRASER 6 COVER

MODELO MODEL	COR COLOR	CAIXA BOX	REFERÊNCIA REFERENCE
NIVELADOR TRASER 6	DIREITO	100 UN	624300036
	ESQUERDO		624300032
CHAPA 31	-	200 UN	621900031
	18 MM	14 000 UN	R900004722
TAMPA TRASER 6	● NIQUEL NICKEL	1000 UN	R900004714
	○ BRANCO WHITE	8000 UN	R900004826
	● CINZA GREY		R900004822



APC 3 DIREITO E ESQUERDO
RIGHT AND LEFT APC 3 HANGER

CHAPA APC WPC2
APC WPC2 WALL PLATE

TAMPA Ø20MM APC
APC COVER CAP Ø20MM

MODELO MODEL	COR COLOR	CAIXA BOX	REFERÊNCIA REFERENCE
APC 3 DIREITO	● ZINCADO ZINC	100 UN	65210040ZN
APC 3 ESQUERDO	● ZINCADO ZINC	100 UN	65210050ZN
CHAPA APC WPC2	● ZINCADO ZINC	100 UN	65230010ZN
	○ BRANCO WHITE		65270100AB
TAMPA Ø20MM APC	● CINZA GREY	2500 UN	65270100IJ
	● ANTRACITE ANTHRACITE		65270100EE



MODELO MODEL	MEDIDAS MEASURES	CAIXA BOX	REFERÊNCIA REFERENCE
BARRA PARA NIVELADORES	2000 X 28	20 UN	65240010ZN
	2000 X 36	10 UN	R908013820

NIVELADORES MÓVEIS SUPERIORES

UPPER MODULE HANGERS

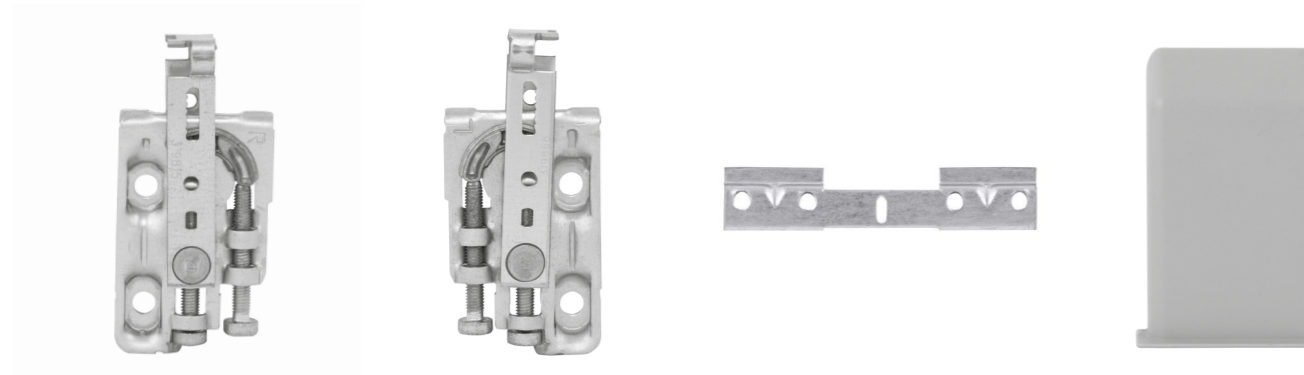

NIVELADOR SCARPI DIREITO
SCARPI RIGHT

NIVELADOR SCARPI ESQUERDO
SCARPI LEFT

CHAPA NIVELADOR 31
31 WALL PLATE

TAMPA SCARPI
SCARPI COVER

MODELO MODEL		COR COLOR	CAIXA BOX	REFERÊNCIA REFERENCE
NIVELADOR SCARPI	DIREITO	● ZINCADO ZINC	200 UN	625100033
	ESQUERDO	● ZINCADO ZINC	200 UN	625000036
CHAPA NIVELADOR 31	-	● ZINCADO ZINC	200 UN	621900031
	DIREITO	○ BRANCO WHITE	400 UN	639700003
TAMPA SCARPI	ESQUERDO	○ BRANCO WHITE	400 UN	639600006
	DIREITO	● CINZA GREY	400 UN	639700143
	ESQUERDO	● CINZA GREY	400 UN	639600146
	DIREITO	● NIQUEL NICKEL	400 UN	639100066
	ESQUERDO	● NIQUEL NICKEL	400 UN	639000062

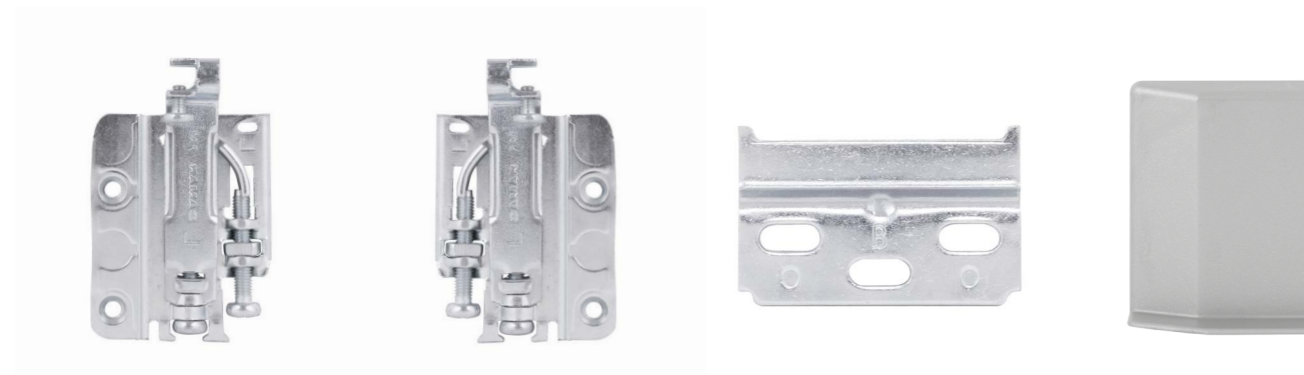

NIVELADOR 701 DIREITO
701 RIGHT

NIVELADOR 701 ESQUERDO
701 LEFT

CHAPA NIVELADOR 701
701 WALL PLATE

TAMPA 701
701 COVER

MODELO MODEL		COR COLOR	CAIXA BOX	REFERÊNCIA REFERENCE
NIVELADOR 701	DIREITO	● ZINCADO ZINC	200 UN	R900005420
	ESQUERDO	● ZINCADO ZINC	200 UN	R900005520
CHAPA NIVELADOR 701	-	● ZINCADO ZINC	800 UN	R900005620
	DIREITO	○ BRANCO WHITE	400 UN	R900005826
TAMPA 701	ESQUERDO	○ BRANCO WHITE	400 UN	R900005926
	DIREITO	● CINZA GREY	400 UN	R900005822
	ESQUERDO	● CINZA GREY	400 UN	R900005922



NIVELADORES MÓVEIS INFERIORES

BOTTOM MODULE HANGERS



NIVELADOR LIBRA H6 DIREITO E ESQUERDO
LIBRA H6 LEFT AND RIGHT

CHAPA NIVELADOR LIBRA WP5
LIBRA WP5 WALL PLATE

TAMPA
COVER

MODELO MODEL		COR COLOR	CAIXA BOX	REFERÊNCIA REFERENCE
NIVELADOR LIBRA H6	DIREITO	● ZINCADO ZINC	50 UN	634205002N
	ESQUERDO	● ZINCADO ZINC	50 UN	634205102N
CHAPA NIVELADOR LIBRA WP5	-	● ZINCADO ZINC	100 UN	634500502N
		○ BRANCO WHITE		63463010AB
TAMPA	-	● CINZA GREY	100 UN	63463010IJ
		● ANTRACITE ANTHRACITE		63463010EE

i PODE UTILIZAR COM AS TAMPAS LIBRA H2
CAN BE USED WITH LIBRA H2 COVERS



NIVELADOR LIBRA H7 DIREITO E ESQUERDO
LIBRA H7 LEFT AND RIGHT

CHAPA NIVELADOR LIBRA WP5
LIBRA WP5 WALL PLATE

MODELO MODEL		COR COLOR	CAIXA BOX	REFERÊNCIA REFERENCE
NIVELADOR LIBRA H7	DIREITO	● ZINCADO ZINC	50 UN	634222002N
	ESQUERDO	● ZINCADO ZINC	50 UN	634222102N
CHAPA NIVELADOR LIBRA WP5	-	● ZINCADO ZINC	100 UN	634500502N
	BARRA LIBRA H7	● ZINCADO ZINC	06 UN	6704000000

NIVELADORES MÓVEIS INFERIORES

BOTTOM MODULE HANGERS

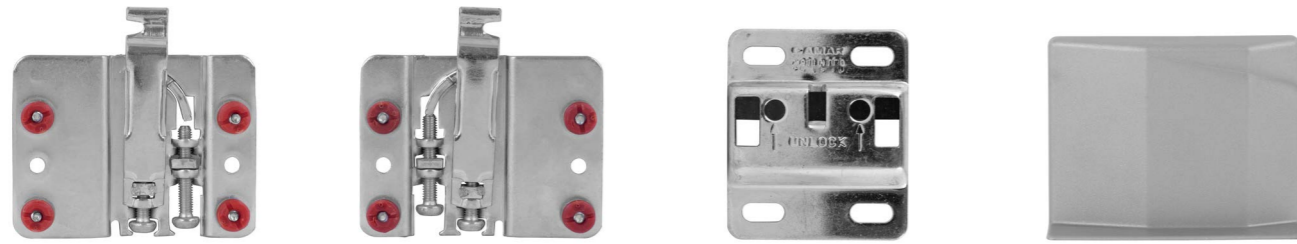

NIVELADOR 807 DIREITO
807 RIGHT

NIVELADOR 807 ESQUERDO
807 LEFT

CHAPA NIVELADOR 807
807 WALL PLATE

TAMPA 807
807 COVER

MODELO MODEL	COR COLOR	CAIXA BOX	REFERÊNCIA REFERENCE
NIVELADOR 807	DIREITO	100 UN	R900006020
	ESQUERDO		R900006120
CHAPA NIVELADOR 807	ZINCADO ZINC	200 UN	R900006220
TAMPA 807	DIREITO	400 UN	R900006322
	ESQUERDO		R900006422

PÉS NIVELADORES

LEVELLERS



PÉ NIVELADOR ALLEN M8
ALLEN M8 LEVELLER

PÉ NIVELADOR ALLEN M10
ALLEN M10 LEVELLER

ATI NIVELADOR M10
ATI M10 ADJUSTABLE FOOT

NIVELADOR CIRCULAR
CIRCULAR LEVELLER

MODELO MODEL	MEDIDA MEASURES	CAIXA BOX	REFERÊNCIA REFERENCE
PE NIVELADOR M8 ALLEN	D24XH29	500 UN	R900017820
	D24XH41		R900017720
	D24XH58		R900017620
PE NIVELADOR M10 ALLEN	D23XH38	500 UN	R900018320
	D23XH46		R900018420
	D23XH61		R900018520
	D23XH80		250 UN
ATI NIVELADOR M8	D24XH42	500 UN	R900017520
ATI NIVELADOR M10	D23XH46	120 UN	R900012820
NIVELADOR CIRCULAR	D48XH17	500 UN	K510022021
	D48XH27		K510022121
	D48XH44	400 UN	K510022221
	D48XH48	250 UN	K510022321

PÉS NIVELADORES

LEVELLERS



INTEGRATO Z
INTEGRATO Z LEVELLER

INTEGRATO G
INTEGRATO G LEVELLER

M6XH30
M6XH30 LEVELLER

MODELO MODEL	MEDIDA MEASURES	CAIXA BOX	REFERÊNCIA REFERENCE
INTEGRATO Z	H12MM (AJUSTÁVEL)	250 UN	35070010EA
INTEGRATO G	H12MM (AJUSTÁVEL)	200 UN	3506002000
NIVELADOR M6XH30	-	1250 UN	30501010AB
	-		30501010EA

PORCA DE APARAFUSAR 446
446 NUT FOR SCREWS

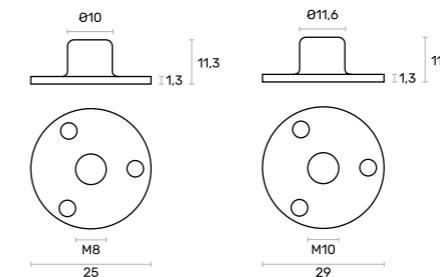

MODELO MODEL	ACABAMENTO FINISHING	CAIXA BOX	REFERÊNCIA REFERENCE
PORCA DE APARAFUSAR 446 - M8	ZINCADO ZINC	1250 UN	R900019120
PORCA DE APARAFUSAR 446 - M10			R900019020

12

ESCRITÓRIO
OFFICE

218 **TOMADAS E GESTÃO DE CABOS**
CABLE MANAGEMENT

221 **PASSA CABOS**
CABLE ORGANIZER

221 **RODÍZIOS**
WHEELS

TOMADA TWIST 2
TWIST 2 TOWER



TOMADA TWIST
TWIST TOWER



TOMADA ELEVATOR
ELEVATOR TOWER



TOMADA DUE
DUE TOWER



TOMADA KAPSA
KAPSA TOWER



TOMADA CONI
CONI TOWER

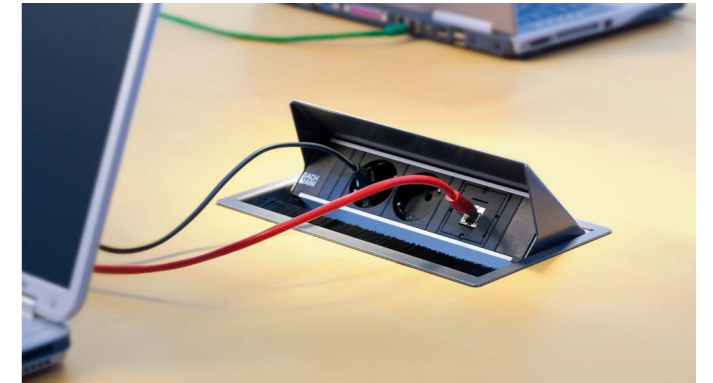

TOMADA POWER FRAME
POWER FRAME TOWER



TOMADA CASIA2
CASIA2 TOWER



MODELO MODEL	TIPO TYPE	COR COLOR	CAIXA BOX	REFERÊNCIA REFERENCE
TWIST 2	2 ENTRADAS	BRANCO WHITE	01 UN	E100946200
		INOX STAINLESS STEEL		E100946000
		PRETO BLACK		E100946100
TWIST	2 ENTRADAS	BRANCO WHITE	01 UN	E100931250
		INOX STAINLESS STEEL		E100931000
		PRETO BLACK		E100931150
	1 ENTRADAS + 2 USB	BRANCO WHITE	01 UN	E100931231
		INOX STAINLESS STEEL		E100931031
		PRETO BLACK		E100931131
ELEVATOR	2 ENTRADAS	PRETO BLACK	01 UN	E100928002 E109280024
		PRETO BLACK		E100928017
	1 ENTRADAS + 2 USB	PRETO BLACK	01 UN	E109280177
DUE	2 ENTRADAS	PRETO BLACK	01 UN	E100929000
TAMPAS	-	BRANCO WHITE	01 UN	E100929102
	-	INOX STAINLESS STEEL		E100929100
	-	PRETO BLACK		E100929101

MODELO MODEL	TIPO TYPE	COR COLOR	CAIXA BOX	REFERÊNCIA REFERENCE
KAPSA	2 ENTRADAS	INOX STAINLESS STEEL PRETO BLACK	01 UN	E100927000
	2 ENTRADAS + 2 USB			E100927001
	TAMPA			E100927100 E100927101
	3 ENTRADAS			E103331007
CONI	2 ENTRADAS + 2 USB A&C	BRANCO WHITE ALUMÍNIO ALUMINIUM	01 UN	E100912233
	TAMPA			E100911000 E103380203
	3 ENTRADAS			E109161192
POWER FRAME	2 ENTRADAS + 2 USB A&C	ALUMÍNIO ALUMINIUM PRETO BLACK	01 UN	E100916501 E100915500
	TAMPA			E100915033
	2 ENTRADAS + 2 USB A&C			INOX STAINLESS STEEL PRETO BLACK

TOMADAS E GESTÃO DE CABOS

CABLE MANAGEMENT

PASSA CABOS

CABLE ORGANIZER

TOMADA TOWER
EXIT POWER TOWER



TOMADA EXIT 45 PLUS
EXIT POWER 45 PLUS



MODELO MODEL	CAIXA BOX	REFERÊNCIA REFERENCE
TOMADA TOWER 100	3 ENTRADAS + 2 USB	E102095317
TOMADA TOWER 60	3 ENTRADAS + 2 USB	E102095117
TOMADA EXIT 4 PLUS	2 ENTRADAS + 2 RJ45 + 2 USB	E102078435



TOMADA MAXI
MAXI POWER



TOMADA DOCK
DOCK POWER



TOMADA SPOT
SPOT POWER



MODELO MODEL	CAIXA BOX	REFERÊNCIA REFERENCE
TOMADA MAXI	4 ENTRADAS + 2 USB A&C + 2 RJ45 + WLC	E102095421
TOMADA DOCK	2 USB	E100003122
TOMADA SPOT	1 ENTRADA + 1 PASSA CABOS	E100003221
TOMADA SPOT USB	1 ENTRADA + 1 USB	E100003321

FECHADURA 288
ROUND CABLE ORGANIZER



PASSA CABOS SQUARE
SQUARE CABLE ORGANIZER



PASSA CABOS ROUND
ROUND CABLE ORGANIZER



MODELO MODEL	ACABAMENTO FINISHING	CAIXA BOX	REFERÊNCIA REFERENCE
FECHADURA 288 PARA BLOCO DE GAVETAS	ANODIZADO ANODIZED	465MM	E100001201
		673MM	E100001301
i COM 2 CHAVES WITH 2 KEYS			
PASSA CABOS SQUARE	INOX ESCOVADO STAINLESS STEEL	80X80	E100000425
		80X150	E100000525
		80X270	E100000625
PASSA CABOS ROUND	BRANCO WHITE	60	E100000726
		60	E100000730
		80	E100000830

RODÍZIOS

WHEELS



RODA EGO
EGO WHEEL

RODA EGO C/TRAVÃO
EGO WHEEL WITH BRAKE

RODA GOA
GOA WHEEL

RODA GOA C/TRAVÃO
GOA WHEEL WITH BRAKE

RODA ROB
ROB WHEEL

MODELO MODEL	MEDIDA MEASURES	CAIXA BOX	REFERÊNCIA REFERENCE
RODA EGO	D50/10MM		E109233121
RODA EGO C/TRAVÃO	D50/10MM		E109233221
RODA GOA	D50 (42X42)		E100000130
RODA GOA C/TRAVÃO	D50 (42X42)		E100000230
RODA ROB	D13		E100000321

13

OUTROS
PRODUTOS
OTHER
PRODUCTS

~~224~~ **TRATAMENTO DE MADEIRA**
WOOD WORK

~~226~~ **DIVERSOS**
OTHERS

~~227~~ **EMBALAMENTO**
PACKAGING

TRATAMENTO DE MADEIRA

WOOD WORK

TRATAMENTO DE MADEIRA

WOOD WORK

RETOCADOR

COLOR EDGING PEN

BETUMES

ECOFILLER

CERA DE RETOQUE

RETOUCH WAX



MODELO MODEL	ACABAMENTO FINISHING	CAIXA BOX	REFERÊNCIA REFERENCE
RETOCADOR HOLZ	ANTRACITE - 35	01 UN	PA11035001
	BRANCO - 50		PA11050001
	CASTANHO - 49		PA11049002
	CINZA CLARO - 7038		PA11078381
	PRATA - 15		PA11015001
	PRETO - 60		PA11060001
MADEIRA WOOD			
RETOCADOR PROFIX	CEREJEIRA - 30	01 UN	PA11030002
	CEREJEIRA CLARO - 29		PA11029002
	CEREJEIRA ESCURO - 16		PA11016002
	CARVALHO ESCURO - 52		PA11052002
	CARVALHO CLARO - 51		PA11051002
	DOUGLAS - 54		PA11054002
	NOGUEIRA CLARO - 53		PA11053002
	NOGUEIRA ESCURO - 63		PA11063002
	NOGUEIRA MEDIO - 59		PA11059002
	MOGNO - 62		PA11062002
	MOGNO CLARO - 36		PA11036002
	PINHO - 05		PA11005002
	POIRIER - 120		PA11012002
	PRETO - 60		PA11060002
	TEAK - 17		PA11017002
	WENGUE - 146		PA11014602
	BETUMES		ABETE 200G
BRANCO 200G / 1KG		PA11025050 / PA11100050	
CEREJEIRA 200G		PA11025030	
CEREJEIRA CLARO 1KG		PA11100029	
CEREJEIRA ESCURA 1KG		PA11100066	
CARVALHO ESCURO 200G / 1KG / 5KG		PA11025051 / PA11100051	
DOUGLAS 5KG		PA11500054	
FAIA VAPORIZADA 200G		PA11025042	
FAIA 1KG		PA11100042	
MOGNO 200G		PA11025062	
NOGUEIRA CLARO 200G		PA11025053	
NOGUEIRA ESCURO 200G / 1KG		PA11025033 / PA11100053	
PINHO 200G / 1KG		PA11025005 / PA11100005	
PRETO 200G		PA11025060	
WENGUE 200G	PA11250146		

MODELO MODEL	ACABAMENTO FINISHING	CAIXA BOX	REFERÊNCIA REFERENCE		
CERA DE RETOQUE	AMARELO CROMO	01 UN	PA1100CR121		
	BRANCO - 50		PA1100CR50		
	CASTANHO PRETO - 47		PA1100CR47		
	CINZA CLARO - 100		PA1100CR100		
	CINZA CIMENTO - 103		PA1100CR103		
	CINZA PO - 104		PA1100CR104		
	PRATA - 15		PA1100CR015		
	PRETO - 60		PA1100CR60		
	MADEIRA WOOD				
	ACER/MAPLE - 015		01 UN	PA1100CR15	
	CARVALHO CLARO - 51			PA1100CR51	
	CARVALHO ESCURO - 52			PA1100CR52	
	CARVALHO NATURAL - 01			PA1100CR01	
	CARVALHO NATURAL - 02			PA11000CR2	
	CARVALHO 4 RUSTICO - 44			PA1100CR44	
CARVALHO 2 RUSTICO - 45	PA1100CR45				
CEREJEIRA - P. 16	PA1100CR16				
CEREJEIRA - 30	PA1100CR30				
FAIA ESCURO - 21	PA1100CR21				
LARICE/CEDRO - 10	PA1100CR10				
LARICE/CEDRO MEDIO - 22	PA1100CR22				
MADEIRA NATURAL - 08	PA1100CR08				
NOGUEIRA CLARO - P10 53	PA1100CR53				
NOGUEIRA NACIONAL - 55	PA1100CR55				
NOGUEIRA MEDIA - P11 59	PA1100CR59				



FITA MÉTRICA STANLEY TYLON E EKO
STANLEY TYLON AND EKO MEASURING TAPE

LUVAS NITRILO
NITRILE GLOVES

X-ATO C/TRAVÃO
X-ACT WITH BRAKE

CARTÃO CANELADO
CORRUGATED CARDBOARD

ROLO FILME MANUAL TRANSPARENTE
TRANSPARENT HAND FILM ROLL

MODELO MODEL	MEDIDA MEASURES	CAIXA BOX	REFERÊNCIA REFERENCE
FITA MÉTRICA STANLEY TYLON	3000	01 UN	0130000921
	5000		0130001021
FITA MÉTRICA EKO	5000	01 UN	0130430621
LUVAS NITRILO	N.8 (TAMANHO S)	01 UN	0130001100
	N.9 (TAMANHO M)		0130001200
	N.10 (TAMANHO L)		0130001300
X-ATO C/TRAVÃO	LÂMINA 18MM	01 UN	R900890085

MODELO MODEL	MEDIDA MEASURES	CAIXA BOX	REFERÊNCIA REFERENCE
CARTÃO CANELADO	H.1000	01 UN	0130000100
	H.1100		0130000200
	H.1200		0130000300
ROLO FILME MANUAL TRANSPARENTE	300 METROS	06 UN	0130000419



FITA COLA TRANSPARENTE
TRANSPARENT ADHESIVE TAPE

FITA COLA FRGIL
FRAGILE ADHESIVE TAPE

FITA COLA MASKING
MASKING ADHESIVE TAPE

DESENROLADOR FITA COLA
ADHESIVE TAPE MACHINE

MODELO MODEL	MEDIDA MEASURES	CAIXA BOX	REFERÊNCIA REFERENCE
FITA COLA TRANSPARENTE	48MM	06 UN	0130000519
FITA COLA FRÁGIL	48MM	06 UN	0130000600
FITA COLA MASKING	38MM	08 UN	0130000727
DESENROLADOR FITA COLA	-	01 UN	0130000800

