

03

ASAS E PUXADORES HANDLES AND KNOBS

44 PUXADORES EDGE
EDGE HANDLES

48 ASAS PARA MÓVEIS
DOOR HANDLES

55 PUXADORES PARA MÓVEIS
KNOBS

56 CONCHAS PARA MÓVEIS
FURNITURE HANDLES

EDGE

PUXADORES EDGE EDGE HANDLES

EXEMPLO REFERÊNCIA
REFERENCE EXAMPLE

MODELO
MODEL

A494004501

ACABAMENTO
FINISHING

MEDIDA TOTAL (MM)
TOTAL MEASURE (MM)

- | | | |
|--|---|--|
| 01 ● ANODIZADO
ANODIZED | 02 ○ BRANCO BRILHO
BRIGHT WHITE | 03 ○ BRANCO MATE
MATTE WHITE |
| 08 ● PRETO BRILHO
BRIGHT BLACK | 09 ● PRETO MATE
MATTE BLACK | 29 ● ALTO BRILHO
SHINE |

MEDIDA TOTAL (MM) TOTAL MEASURE (MM)	0045	0348	0698	1298
	0104	0398	0798	1398
	0150	0448	0898	1498
	0198	0498	0998	1598
	0248	0548	1098	1698
	0298	0598	1198	1798

PUXADOR 07 HANDLE 07

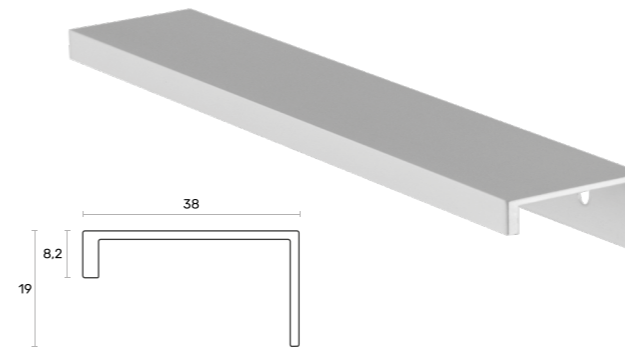

PUXADOR 12 HANDLE 12

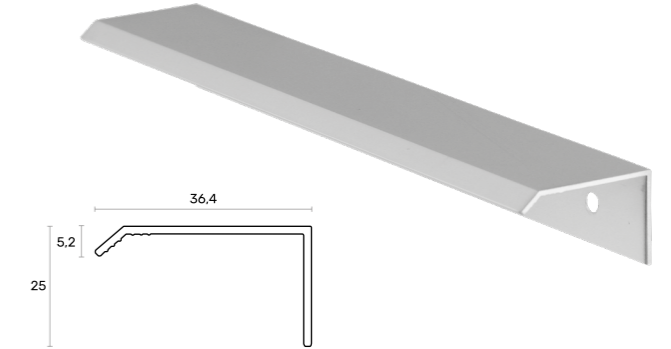

MODELO MODEL	ACABAMENTO FINISHING	MEDIDA MÁXIMA MAX. MEASURE	CAIXA BOX	REFERÊNCIA REFERENCE
PUXADOR 07 E PUXADOR 12	○ BRANCO MATE MATTE WHITE	5000 MM	01 UN	A407 0045 03 / A412 0045 03
	○ BRANCO BRILHO BRIGHT WHITE	5000 MM		A407 0045 02 / A412 0045 02
	● PRETO MATE MATTE BLACK	5000 MM		A407 0045 09 / A412 0045 09
	● PRETO BRILHO BRIGHT BLACK	5000 MM		A407 0045 08 / A412 0045 08
	● ANODIZADO ANODIZED	5000 MM		A407 0045 01 / A412 0045 01

PUXADOR 03 HANDLE 03

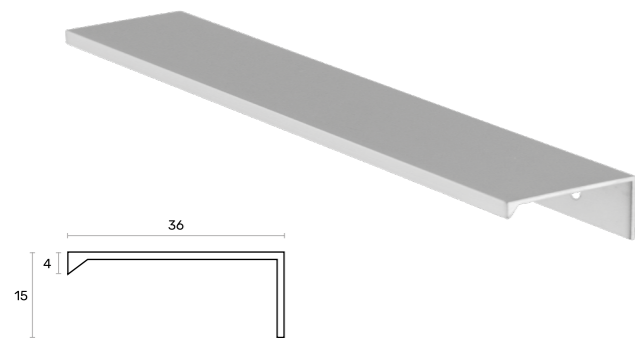

PUXADOR 05 HANDLE 05

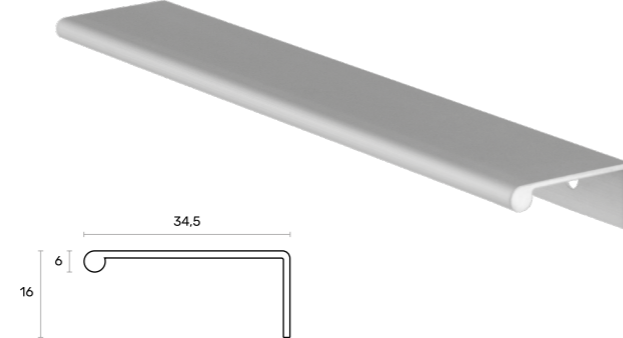

MODELO MODEL	ACABAMENTO FINISHING	MEDIDA MÁXIMA MAX. MEASURE	CAIXA BOX	REFERÊNCIA REFERENCE
PUXADOR 03 E PUXADOR 05	○ BRANCO MATE MATTE WHITE	3000 MM	01 UN	A403 0045 03 / A405 0045 03
	○ BRANCO BRILHO BRIGHT WHITE	3000 MM		A403 0045 02 / A405 0045 02
	● PRETO MATE MATTE BLACK	3000 MM		A403 0045 09 / A405 0045 09
	● PRETO BRILHO BRIGHT BLACK	3000 MM		A403 0045 08 / A405 0045 08
	● ANODIZADO ANODIZED	3000 MM / 5000 MM		A403 0045 01 / A405 0045 01
	● ALTO BRILHO SHINE	3000 MM		A403 0045 29

PUXADOR 34 HANDLE 34

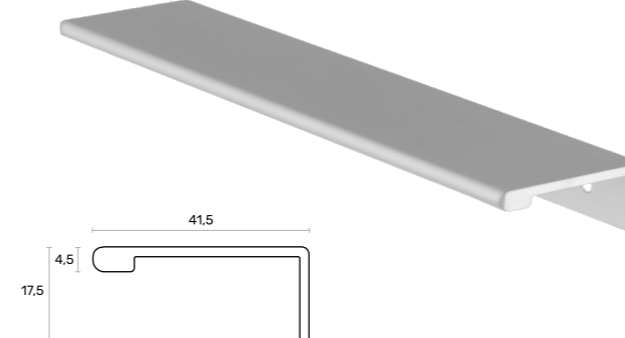

PUXADOR 94 HANDLE 94

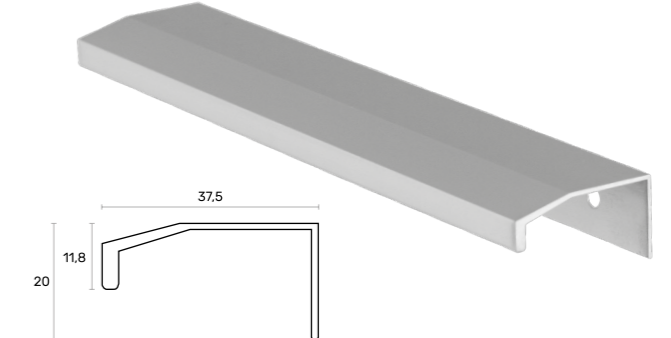

MODELO MODEL	ACABAMENTO FINISHING	MEDIDA MÁXIMA MAX. MEASURE	CAIXA BOX	REFERÊNCIA REFERENCE
PUXADOR 34 E PUXADOR 94	○ BRANCO MATE MATTE WHITE	5000 MM	01 UN	A434 0045 03 / A494 0045 03
	○ BRANCO BRILHO BRIGHT WHITE	5000 MM		A434 0045 02 / A494 0045 02
	● PRETO MATE MATTE BLACK	5000 MM		A434 0045 09 / A494 0045 09
	● PRETO BRILHO BRIGHT BLACK	5000 MM		A434 0045 08 / A494 0045 08
	● ANODIZADO ANODIZED	5000 MM		A434 0045 01 / A494 0045 01

PUXADORES EDGE

EDGE HANDLES

PUXADOR 09 - A

HANDLE 09 - A

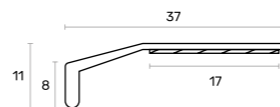
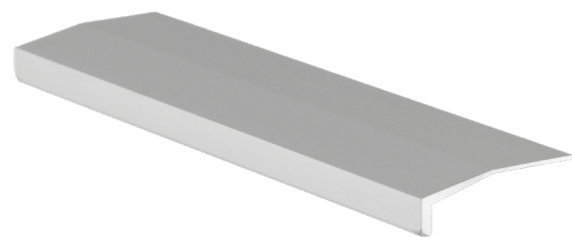

MODELO MODEL	ACABAMENTO FINISHING	MEDIDA TOTAL TOTAL MEASURE	CAIXA BOX	REFERÊNCIA REFERENCE
PUXADOR 09-A	● ANODIZADO ANODIZED	65 MM	01 UN	A409006501A
		90 MM		A409009001A
		150 MM		A409015001A
		3000 MM		A409300001A
		4000 MM		A409400001A
		5000 MM		A409500001A

! PARA PORTAS DE ALUMÍNIO / COM AUTOCOLANTE
FOR ALUMINUM DOORS / WITH STICKER

PUXADOR N°1

HANDLE N°1

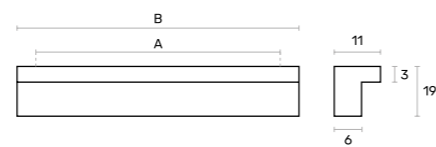

MODELO MODEL	ACABAMENTO FINISHING	MEDIDA ENTRE FUROS MEASURE BETWEEN HOLES	MEDIDA TOTAL TOTAL MEASURE	CAIXA BOX	REFERÊNCIA REFERENCE
N°1	● ANODIZADO ANODIZED	32	52	05 UN	A400007201
		64	84		A400007301
		96	116		A400007401
		128	148		A400007501
		160	180		A400007601
		192	212		A400007701
		-	5000	10 UN	A4N1500001

* TAMBÉM PRODUZIMOS À MEDIDA.

A MEDIDA ENTRE FUROS
MEASURE BETWEEN HOLES

B MEDIDA TOTAL
TOTAL MEASURE

M4 INCLUÍDOS
M4 INCLUDED

PUXADORES EDGE

EDGE HANDLES

PUXADOR J2

J2 HANDLE

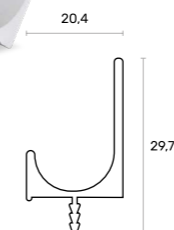

PUXADOR J2Q

J2Q HANDLE

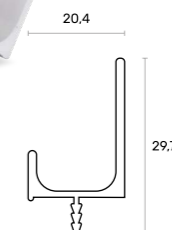

PUXADOR U2

U2 HANDLE

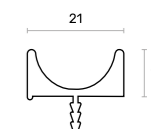

MODELO MODEL	ACABAMENTO FINISHING	COMPIMENTO TOTAL TOTAL LENGTH	CAIXA BOX	REFERÊNCIA REFERENCE
PUXADOR J2	○ BRANCO MATE MATTE WHITE	5000	10 UN	A4J2 0045 03
	○ BRANCO BRILHO BRIGHT WHITE			A4J2 0045 02
	● ANODIZADO ANODIZED			A4J2 0045 01
	● PRETO MATE MATTE BLACK			A4J2 0045 09
PUXADOR J2Q	○ PRETO BRILHO BRIGHT BLACK	5000	10 UN	A4J2 0045 08
	○ BRANCO BRILHO BRIGHT WHITE			A4J2 0045 02
PUXADOR U2	● ANODIZADO ANODIZED	3000	10 UN	A4U2 0045 01

PUXADORES J3 E U3

J3 AND U3 HANDLES

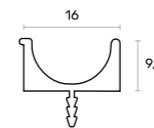
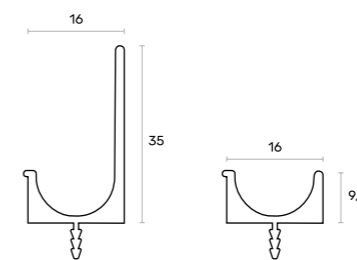

MODELO MODEL	ACABAMENTO FINISHING	COMPIMENTO TOTAL TOTAL LENGTH	CAIXA BOX	REFERÊNCIA REFERENCE
PUXADOR J3	● ANODIZADO ANODIZED	5000	10 UN	A4J3 0045 01
PUXADOR U3				A4U3 0045 01

ASAS PARA MÓVEIS

DOOR HANDLES

ASA 216

HANDLE 216

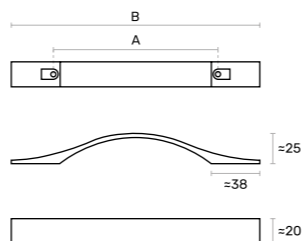
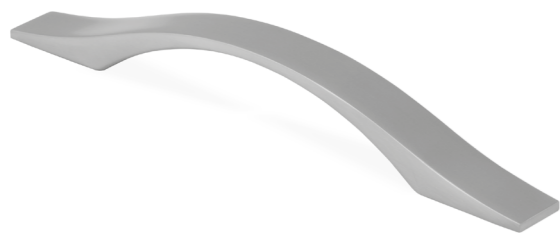

MODELO MODEL	ACABAMENTO FINISHING	MEDIDA ENTRE FUROS MEASURE BETWEEN HOLES	MEDIDA TOTAL TOTAL MEASURE	CAIXA BOX	REFERÊNCIA REFERENCE
216	BSN BSN	128	197	300 UN / 30 UN	A400001113
		160	229	400 UN / 40 UN	A400001213

A MEDIDA ENTRE FUROS
MEASURE BETWEEN HOLES

B MEDIDA TOTAL
TOTAL MEASURE

M4 INCLUIDOS
M4 INCLUDED

ASA 1.6

HANDLE 1.6

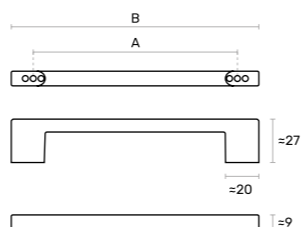

MODELO MODEL	ACABAMENTO FINISHING	MEDIDA ENTRE FUROS MEASURE BETWEEN HOLES	MEDIDA TOTAL TOTAL MEASURE	CAIXA BOX	REFERÊNCIA REFERENCE
1.6	BSN BSN	96	123	350 UN / 35 UN	A400014613
	PRETO MATE BLACK	128	155	300 UN / 30 UN	A400012009
	BSN BSN				A400012013
	PRETO MATE BLACK	160	188	300 UN / 30 UN	A400012109
	BSN BSN	192	223	200 UN / 20 UN	A400012113
	PRETO MATE BLACK				A400012209
	BSN BSN	224	251	210 UN / 35 UN	A400012213
	BSN BSN				A400012313
BSN BSN	256	287	120 UN / 20 UN	A400012413	
		320	353	120 UN / 20 UN	A400012513

A MEDIDA ENTRE FUROS
MEASURE BETWEEN HOLES

B MEDIDA TOTAL
TOTAL MEASURE

M4 INCLUIDOS
M4 INCLUDED

ASAS PARA MÓVEIS

DOOR HANDLES

ASA 220

HANDLE 220

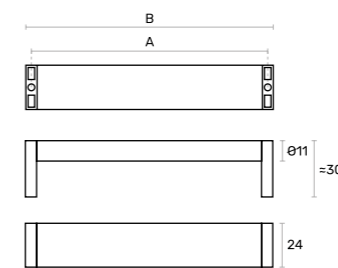
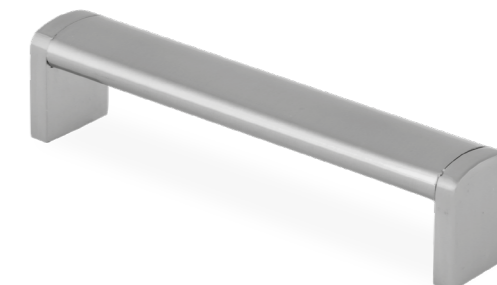

MODELO MODEL	ACABAMENTO FINISHING	MEDIDA ENTRE FUROS MEASURE BETWEEN HOLES	MEDIDA TOTAL TOTAL MEASURE	CAIXA BOX	REFERÊNCIA REFERENCE
220	BSN BSN	128	134	150 UN / 15 UN	A400000113
		160	166		A400000213
		192	198	100 UN / 10 UN	A400000313
		256	262	90 UN / 15 UN	A400000513
		320	326		A400000613

A MEDIDA ENTRE FUROS
MEASURE BETWEEN HOLES

B MEDIDA TOTAL
TOTAL MEASURE

M4 INCLUIDOS
M4 INCLUDED

ASA 503

HANDLE 503

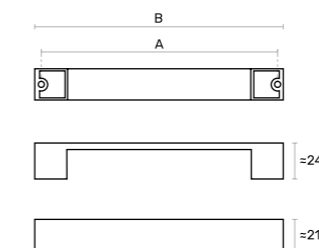
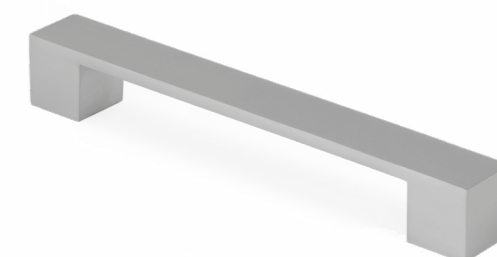

MODELO MODEL	ACABAMENTO FINISHING	MEDIDA ENTRE FUROS MEASURE BETWEEN HOLES	MEDIDA TOTAL TOTAL MEASURE	CAIXA BOX	REFERÊNCIA REFERENCE
503	BSN BSN	160	168	200 UN / 20 UN	A400011813
	CROMADO MATE MATT CHROME PLATED				A400011818
	BSN BSN	192	201	150 UN / 25 UN	A400011913
	CROMADO MATE MATT CHROME PLATED				A400011918

A MEDIDA ENTRE FUROS
MEASURE BETWEEN HOLES

B MEDIDA TOTAL
TOTAL MEASURE

M4 INCLUIDOS
M4 INCLUDED

ASAS PARA MÓVEIS

DOOR HANDLES

ASA 628

HANDLE 628

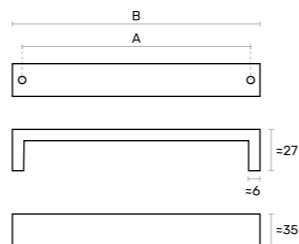
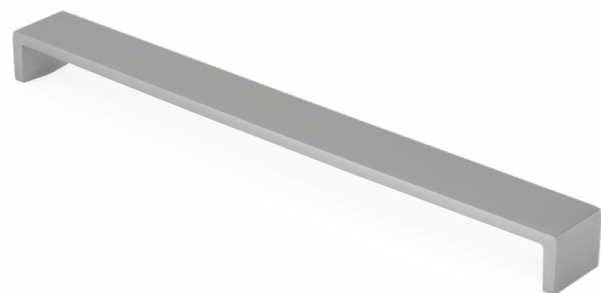

MODELO MODEL	ACABAMENTO FINISHING	MEDIDA ENTRE FUROS MEASURE BETWEEN HOLES	MEDIDA TOTAL TOTAL MEASURE	CAIXA BOX	REFERÊNCIA REFERENCE
628	BSN BSN	320	329	60 UN / 15 UN	A400013313

A MEDIDA ENTRE FUROS
MEASURE BETWEEN HOLES

B MEDIDA TOTAL
TOTAL MEASURE

M4 INCLUIDOS
M4 INCLUDED

ASA 303

HANDLE 303

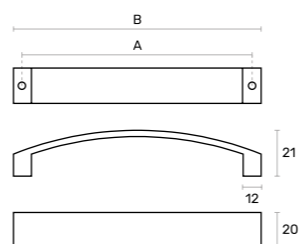

MODELO MODEL	ACABAMENTO FINISHING	MEDIDA ENTRE FUROS MEASURE BETWEEN HOLES	MEDIDA TOTAL TOTAL MEASURE	CAIXA BOX	REFERÊNCIA REFERENCE
303	PRETO MATE BLACK	128	140	250 UN / 25 UN	A400012809
	BSN BSN				A400012813
	CROMADO MATE MATT CHROME PLATED	A400012818			
	BRANCO MATE MATTE WHITE	A400012903			
	PRETO MATE BLACK	160	172	200 UN / 20 UN	A400012909
	BSN BSN	A400012913			
	BSN BSN	192	204	125 UN / 25 UN	A400013013

A MEDIDA ENTRE FUROS
MEASURE BETWEEN HOLES

B MEDIDA TOTAL
TOTAL MEASURE

M4 INCLUIDOS
M4 INCLUDED

ASAS PARA MÓVEIS

DOOR HANDLES

ASA 001

HANDLE 001

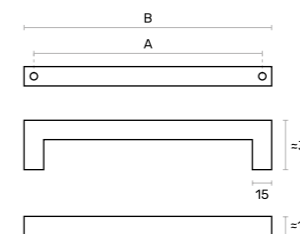
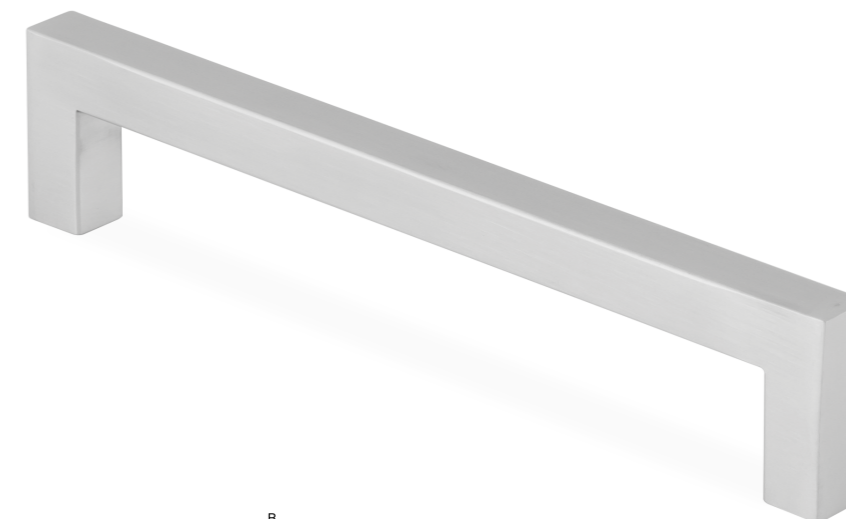

∅15 ASA 001
HANDLE 001

∅12 ASA 5896
HANDLE 5896

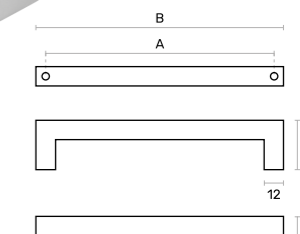

MODELO MODEL	ACABAMENTO FINISHING	MEDIDA ENTRE FUROS MEASURE BETWEEN HOLES	MEDIDA TOTAL TOTAL MEASURE	CAIXA BOX	REFERÊNCIA REFERENCE	
001	BSN BSN	192	206	200 UN / 50 UN	A400011512	
		256	270		A400011612	
		128	140		A400005212	
		160	172		A400005312	
		192	204		200 UN / 50 UN	A400005412
	5896	BSN BSN	224	236	A400005512	
			256	268	A400005612	
			288	300	A400005712	
			320	332	10 UN	A400005812
			480	492	A400005912	
OURO ESCOVADO BRUSHED GOLD		640	652	A400006012		
		160	172	10 UN	A400005334	
		320	332	A400005834		

A MEDIDA ENTRE FUROS
MEASURE BETWEEN HOLES

B MEDIDA TOTAL
TOTAL MEASURE

M4 INCLUIDOS
M4 INCLUDED

ASAS PARA MÓVEIS

DOOR HANDLES

ASAS PARA MÓVEIS

DOOR HANDLES

ASA 101
HANDLE 101

ASA H10
HANDLE H10

ASA H12
HANDLE H12

ASA BA
HANDLE BA

ASA PONTE QUADRADA
SQUARE BRIDGE HANDLE

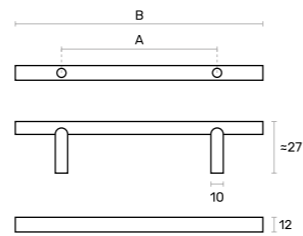
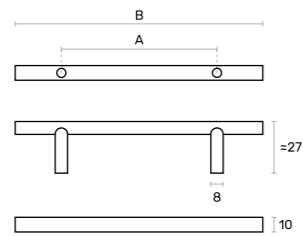
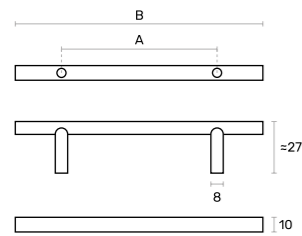
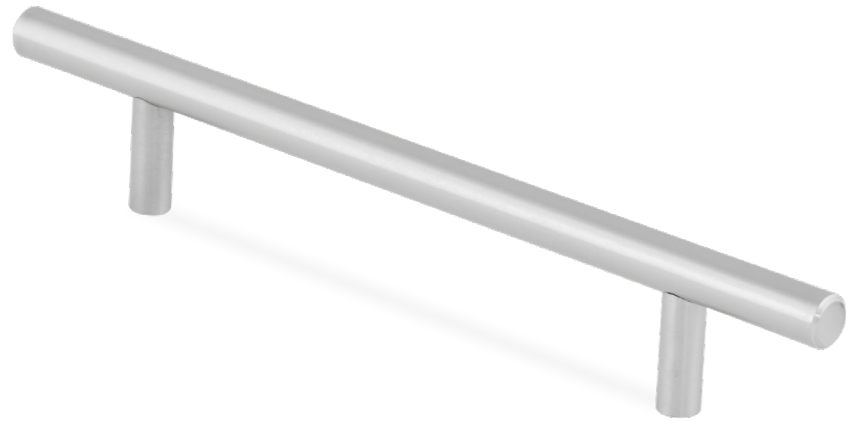

Ø10 INOX SÓLIDO
SOLID STAINLESS STEEL

Ø10 INOX ÔCO
HOLLOW STAINLESS STEEL

Ø12 INOX ÔCO
HOLLOW STAINLESS STEEL

MODELO MODEL	ACABAMENTO FINISHING	MEDIDA ENTRE FUROS MEASURE BETWEEN HOLES	MEDIDA TOTAL TOTAL MEASURE	CAIXA BOX	REFERÊNCIA REFERENCE
101	INOX STAINLESS STEEL	96	161	100 UN / 25 UN	A400002912
		128	193		A400003012
		160	225		A400003112
		192	257		A400003212
		224	289		A400003312
		256	321		A400003412
		320	385		A400003512
H10	INOX STAINLESS STEEL	96	159	400 UN / 50 UN	A400003612
		128	191	500 UN / 50 UN	A400003712
		160	223	400 UN / 50 UN	A400003812
		192	255	400 UN / 50 UN	A400003912
		224	287	400 UN / 50 UN	A400004012
		256	319	300 UN / 50 UN	A400004112
H12	INOX STAINLESS STEEL	320	383	200 UN / 50 UN	A400004312
		128	191	500 UN / 50 UN	A400004512
		160	223	300 UN / 50 UN	A400004612
		192	255	300 UN / 50 UN	A400004712
		256	319	300 UN / 50 UN	A400004912
320	383	200 UN / 50 UN	A400005112		

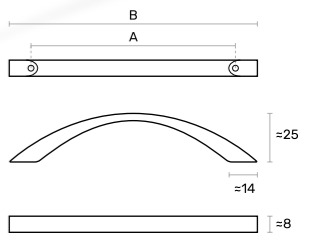
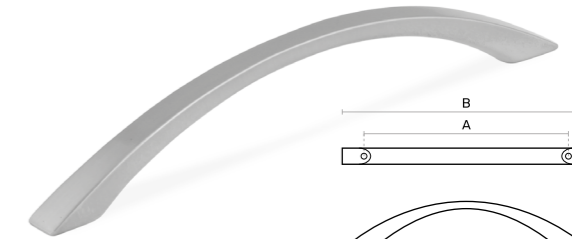
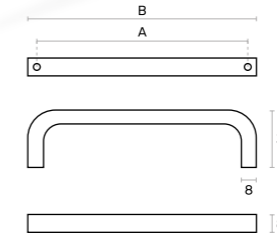

MODELO MODEL	ACABAMENTO FINISHING	MEDIDA ENTRE FUROS MEASURE BETWEEN HOLES	MEDIDA TOTAL TOTAL MEASURE	CAIXA BOX	REFERÊNCIA REFERENCE
BA	INOX STAINLESS STEEL	96	104	05 UN	A400006412
		128	136		A400006512
		160	168		A400006612
		192	192		A400006712
		224	232		A400006812
		256	264		A400006912
PONTE QUADRADA	NIQUELADO ESCOVADO BRUSHED NICKEL	96	113	05 UN	A400007014
	BRONZE BRASS				A400007015
	NIQUELADO ESCOVADO BRUSHED NICKEL	128	145		A400007114
	BRONZE BRASS				A400007115

A MEDIDA ENTRE FUROS
MEASURE BETWEEN HOLES

B MEDIDA TOTAL
TOTAL MEASURE

M4 INCLUIDOS
M4 INCLUDED

ASA 1050 / 1060
HANDLE 1050 / 1060

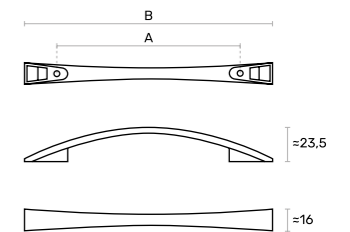

MODELO MODEL	ACABAMENTO FINISHING	MEDIDA ENTRE FUROS MEASURE BETWEEN HOLES	MEDIDA TOTAL TOTAL MEASURE	CAIXA BOX	REFERÊNCIA REFERENCE
1050	BSN BSN	128	169	300 UN / 30 UN	A400001313
	BRONZE BRASS				A400001315
1060	BSN BSN	160	204	250 UN / 25 UN	A400001413
	BRONZE BRASS				A400001415

A MEDIDA ENTRE FUROS
MEASURE BETWEEN HOLES

B MEDIDA TOTAL
TOTAL MEASURE

M4 INCLUIDOS
M4 INCLUDED

ASAS PARA MÓVEIS

DOOR HANDLES

PUXADORES PARA MÓVEIS

KNOBBS

ASA 133

HANDLE 133

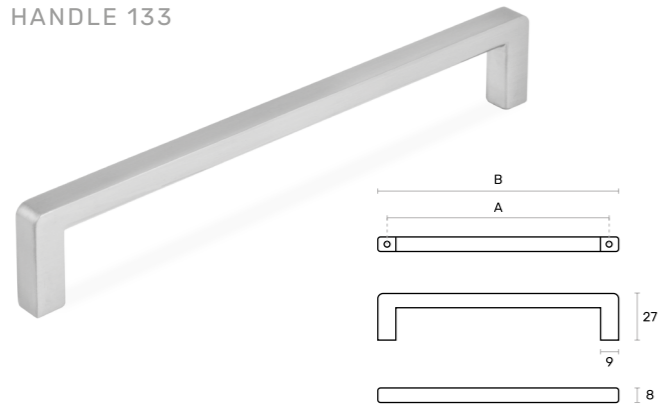

ASA J57

HANDLE J57

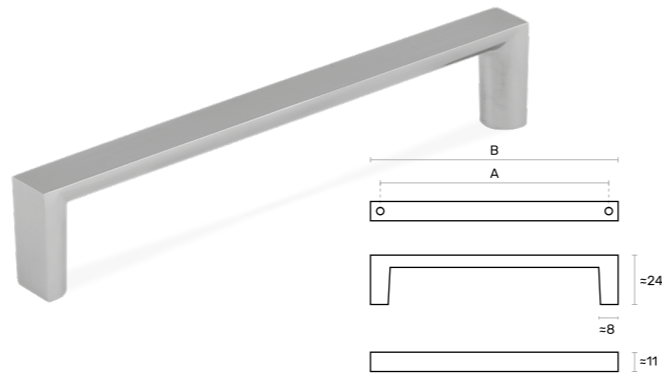

MODELO MODEL	ACABAMENTO FINISHING	MEDIDA ENTRE FUROS MEASURE BETWEEN HOLES	MEDIDA TOTAL TOTAL MEASURE	CAIXA BOX	REFERÊNCIA REFERENCE
133	● PRETO MATE BLACK	128	137	300 UN / 30 UN	A400017209
	● BSN BSN				A400017213
	○ BRANCO MATE MATTE WHITE				A400017303
	● OURO BRILHO BRIGHT GOLD				A400017306
	● PRETO MATE MATTE BLACK	160	169	250 UN / 25 UN	A400017309
	● BSN BSN				A400017313
	○ BRANCO MATE MATTE WHITE				A400017403
	● PRETO MATE BLACK				A400017409
● BSN BSN	192	201	200 UN / 20 UN	A400017413	
● BSN BSN				A400032013	
● BSN BSN				A400032113	
● BSN BSN				A400032213	
J57	● BSN BSN	128	134	20 UN	A400032413
	● BSN BSN	160	166		A400032113
	● BSN BSN	192	198		A400032213
	● BSN BSN	256	262		A400032413

A MEDIDA ENTRE FUROS
MEASURE BETWEEN HOLES

B MEDIDA TOTAL
TOTAL MEASURE

M4 INCLUIDOS
M4 INCLUDED

ASA 246

HANDLE 246

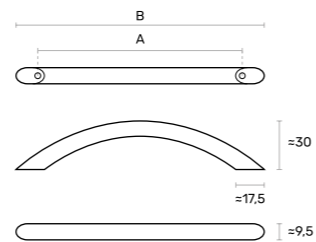

MODELO MODEL	ACABAMENTO FINISHING	MEDIDA ENTRE FUROS MEASURE BETWEEN HOLES	MEDIDA TOTAL TOTAL MEASURE	CAIXA BOX	REFERÊNCIA REFERENCE
246	● PRETO MATE MATTE BLACK	128	155	300 UN / 30 UN	A400012709
	● BSN BSN				A400012613

A MEDIDA ENTRE FUROS
MEASURE BETWEEN HOLES

B MEDIDA TOTAL
TOTAL MEASURE

M4 INCLUIDOS
M4 INCLUDED

PUXADOR N°2

HANDLE N°2



MODELO MODEL	ACABAMENTO FINISHING	MEDIDA ENTRE FUROS MEASURE BETWEEN HOLES	MEDIDA TOTAL TOTAL MEASURE	CAIXA BOX	REFERÊNCIA REFERENCE
N°2	● ANODIZADO ANODIZED	32	72	05 UN	A400007801
		64	104		A400007901
		96	136		A400008001
		128	168		A400008101
		160	200		A400008201

i TAMANHO PERSONALIZÁVEL
ALL SIZES

PUXADOR 1007

KNOB 1007

FACETADO REDONDO / QUADRADO

ROUND FACETADO / SQUARE FACETADO

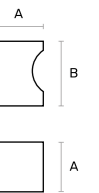
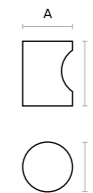
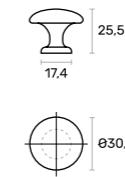

MODELO MODEL	ACABAMENTO FINISHING	MEDIDA TOTAL TOTAL MEASURE	CAIXA BOX	REFERÊNCIA REFERENCE
1007	● BSN BSN	Ø30	500 UN / 50 UN	A400011713
	● BRONZE BRASS			A400011715
REDONDO	● INOX STAINLESS STEEL	Ø12 - 20	100 UN	A400008912
		Ø15 - 22		A400009012
		Ø18 - 22		A400009112
		Ø20 - 24		A400009212
		Ø25 - 28		A400009312
QUADRADO	● INOX STAINLESS STEEL	15 - 22	40 UN	A400009412
		18 - 24	40 UN	A400009512
		20 - 25	30 UN	A400009612

M4 INCLUIDOS
M4 INCLUDED

CONCHAS PARA MÓVEIS

KNOBS

CONCHAS PARA MÓVEIS

KNOBS

CONCHA 4520

KNOB 4520

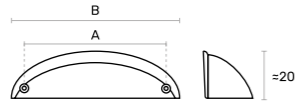

CONCHA 177

KNOB 177

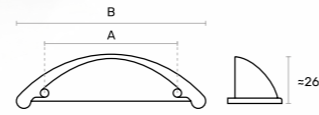

MODELO MODEL	ACABAMENTO FINISHING	MEDIDA ENTRE FUROS MEASURE BETWEEN HOLES	MEDIDA TOTAL TOTAL MEASURE	CAIXA BOX	REFERÊNCIA REFERENCE
4520	CROMADO MATE MATT CHROME PLATED	64	82	01 UN	A400008718
	BRONZE VELHO OLD BRASS				A400008716
177	BRANCO MATE MATTE WHITE	64	104	300 UN / 30 UN	A400017703
	OURO BRILHO BRIGHT GOLD				A400017706
	PRETO MATE MATTE BLACK				A400017709
	BSN BSN				A400017713
	BRONZE BRASS				A400017715
	BRONZE VELHO OLD BRASS	A400017716			

A MEDIDA ENTRE FUROS
MEASURE BETWEEN HOLES

B MEDIDA TOTAL
TOTAL MEASURE

M4 INCLUIDOS
M4 INCLUDED

CONCHA S70

RECESSED HANDLE S70

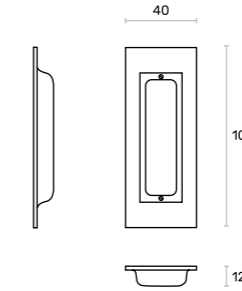

CONCHA S71

RECESSED HANDLE S71

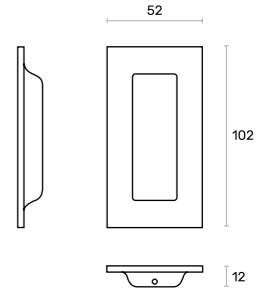

MODELO MODEL	ACABAMENTO FINISHING	MEDIDA ENTRE FUROS MEASURE BETWEEN HOLES	MEDIDA TOTAL TOTAL MEASURE	CAIXA BOX	REFERÊNCIA REFERENCE
S70	BSN BSN	-	102X40X12	300 UN / 30 UN	A400017813
	BRANCO MATE MATTE WHITE				A400017903
S71	BSN BSN	-	102X52X13	200 UN / 10 UN	A400017913
	PRETO MATE MATTE BLACK				A400017909

CONCHA S72

RECESSED HANDLE S72

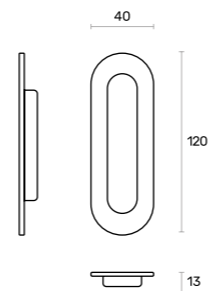
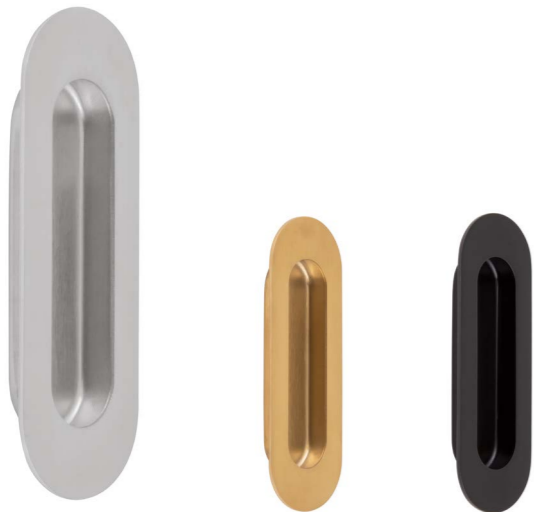

MODELO MODEL	ACABAMENTO FINISHING	MEDIDA ENTRE FUROS MEASURE BETWEEN HOLES	MEDIDA TOTAL TOTAL MEASURE	CAIXA BOX	REFERÊNCIA REFERENCE
S72	PRETO MATE MATTE BLACK	-	120X40X13	200 UN / 10 UN	A400018109
	BSN BSN				A400018113
	OURO ESCOVADO BRUSHED GOLD				A400018134

CONCHA 02

RECESSED HANDLE 02



MODELO MODEL	ACABAMENTO FINISHING	MEDIDA ENTRE FUROS MEASURE BETWEEN HOLES	MEDIDA TOTAL TOTAL MEASURE	CAIXA BOX	REFERÊNCIA REFERENCE
02	BRANCO MATE MATTE WHITE	-	40X40X12	500 UN / 50 UN	A400018003
	PRETO MATE MATTE BLACK				A400018009
	BSN BSN				A400018013